



US00D477172S

(12) **United States Design Patent**
Montague

(10) **Patent No.:** **US D477,172 S**

(45) **Date of Patent:** **** Jul. 15, 2003**

(54) **COMBINATION CHAIRMAT AND FOOTREST**

(76) **Inventor:** **Dale J. Montague**, 26110 Narbonne Ave., Apt. 18, Lomita, CA (US) 90717

(**) **Term:** **14 Years**

(21) **Appl. No.:** **29/162,312**

(22) **Filed:** **Jun. 12, 2002**

(51) **LOC (7) Cl.** **06-11**

(52) **U.S. Cl.** **D6/592**

(58) **Field of Search** D6/582, 583, 592; 428/81, 83; 15/215-217; D12/203

(56) **References Cited**

U.S. PATENT DOCUMENTS

D58,605 S	8/1921	Livingston	
D224,138 S	* 7/1972	Mahler	D6/582
3,700,201 A	10/1972	O'Donnell	
4,046,419 A	9/1977	Schmitt	
4,420,180 A	12/1983	Dupont et al.	
4,654,245 A	3/1987	Balzer et al.	
4,828,898 A	5/1989	Bailey	
4,984,838 A	1/1991	Kim	
5,098,160 A	3/1992	Moore et al.	
D330,988 S	11/1992	Robbins, III	
D355,095 S	* 2/1995	Clever	D6/582
D394,037 S	* 5/1998	Mauffette	D12/203
D394,835 S	* 6/1998	Crute-Williams et al. ..	D12/203
6,183,833 B1	2/2001	Robbins, III et al.	

* cited by examiner

Primary Examiner—Robin V. Taylor

(74) *Attorney, Agent, or Firm*—James G O'Neill

(57) **CLAIM**

The ornamental design for a combination chairmat and footrest, as shown and described.

DESCRIPTION

FIG. 1 is a top plan view of a first embodiment of a combination chairmat and footrest of the present invention;

FIG. 2 is a bottom plan view of FIG. 1;

FIG. 3 is a perspective view, looking at the top from the front of FIG. 1;

FIG. 4 is a rear view of FIG. 1;

FIG. 5 is a front elevational view of FIG. 1;

FIG. 6 is a first side elevational view of FIG. 1; the other side elevational view being a mirror image of this first side elevational view;

FIG. 7 is a top plan view of a second embodiment of a combination chairmat and footrest having a hinge joint therein;

FIG. 8 is a bottom plan view of FIG. 7;

FIG. 9 is a perspective view, looking at the top from the front of FIG. 7;

FIG. 10 is a rear elevational view of FIG. 7;

FIG. 11 is a front elevational view of FIG. 7;

FIG. 12 is a first side elevational view of FIG. 7; the other side elevational view being a mirror image of this first side elevational view;

FIG. 13 is a top plan view of a third embodiment of a combination chairmat and footrest having two hinge joints therein;

FIG. 14 is a bottom plan view of FIG. 13;

FIG. 15 is a perspective view, looking at the top from the front of FIG. 13;

FIG. 16 is a rear elevational view of FIG. 13;

FIG. 17 is a front elevational view of FIG. 14; and,

FIG. 18 is a first side elevational view of FIG. 13; the other side elevation view being a mirror image of this first side elevational view.

1 Claim, 3 Drawing Sheets

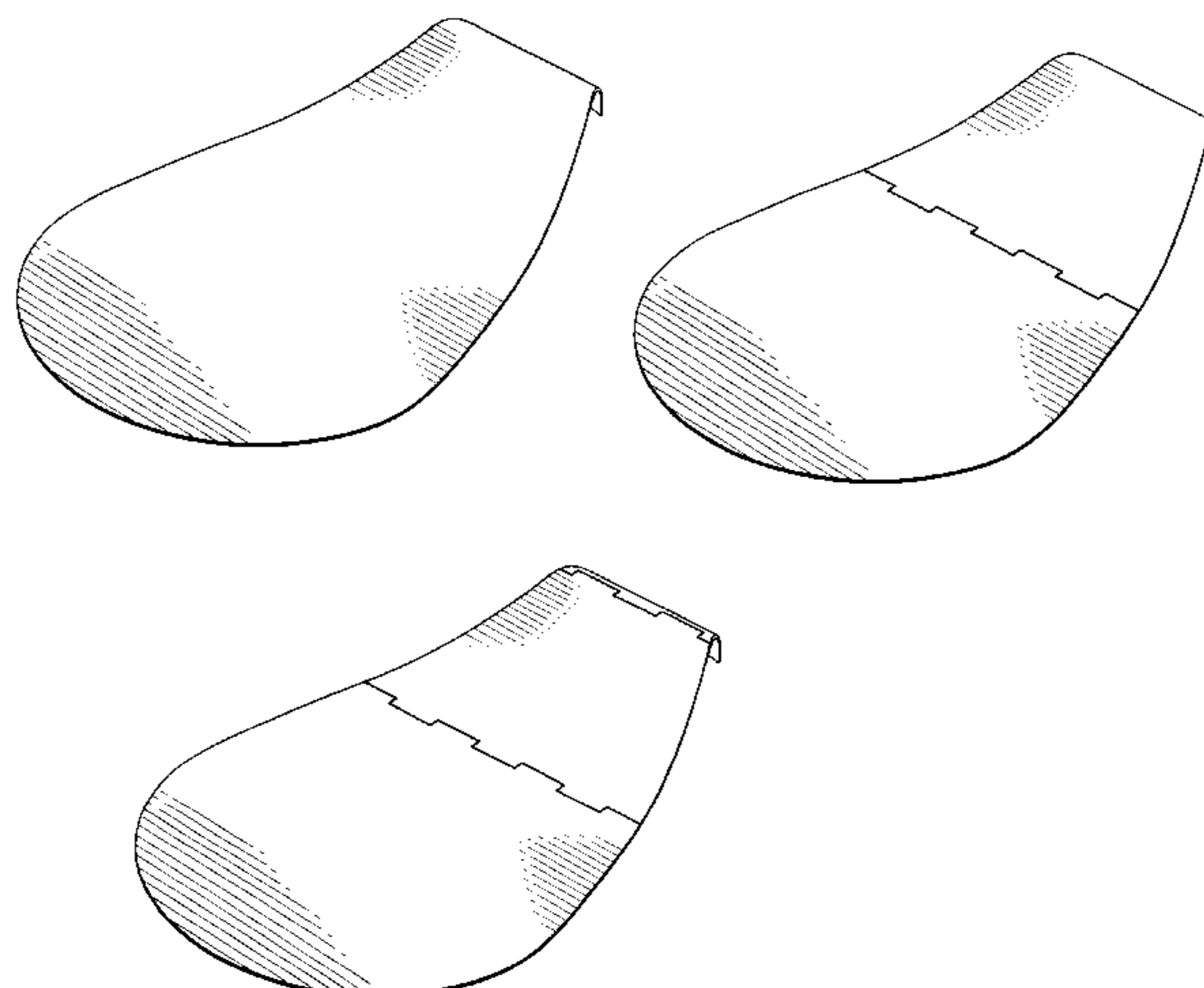

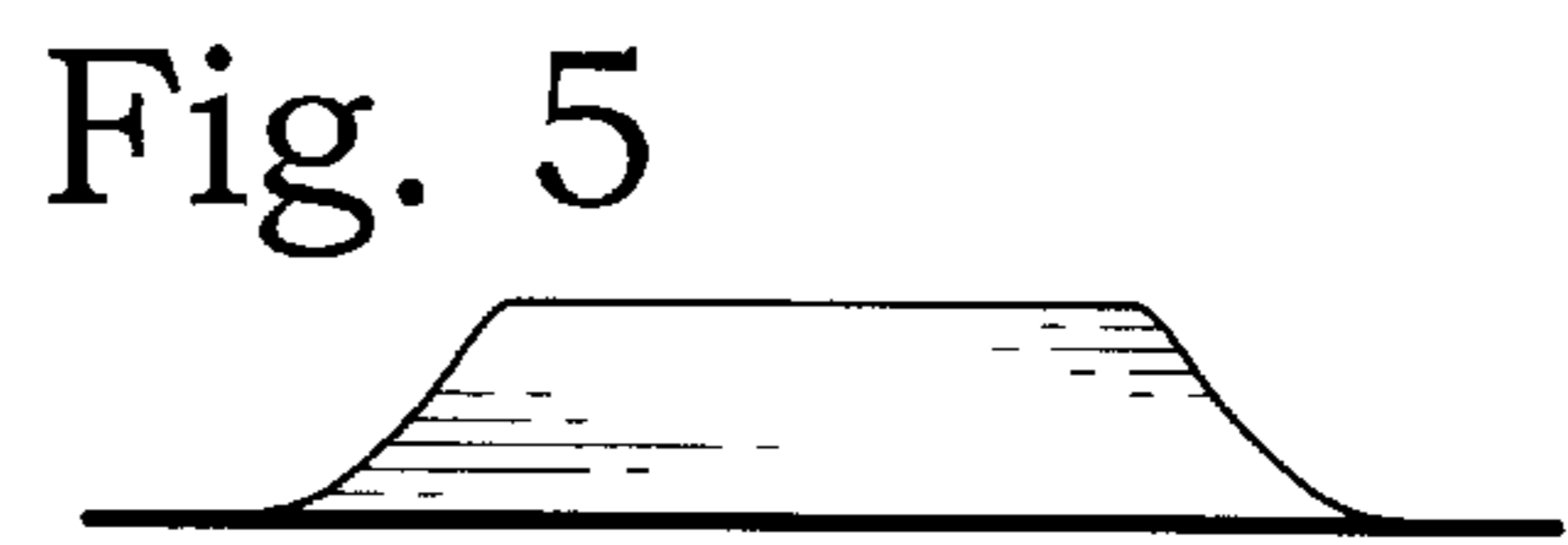
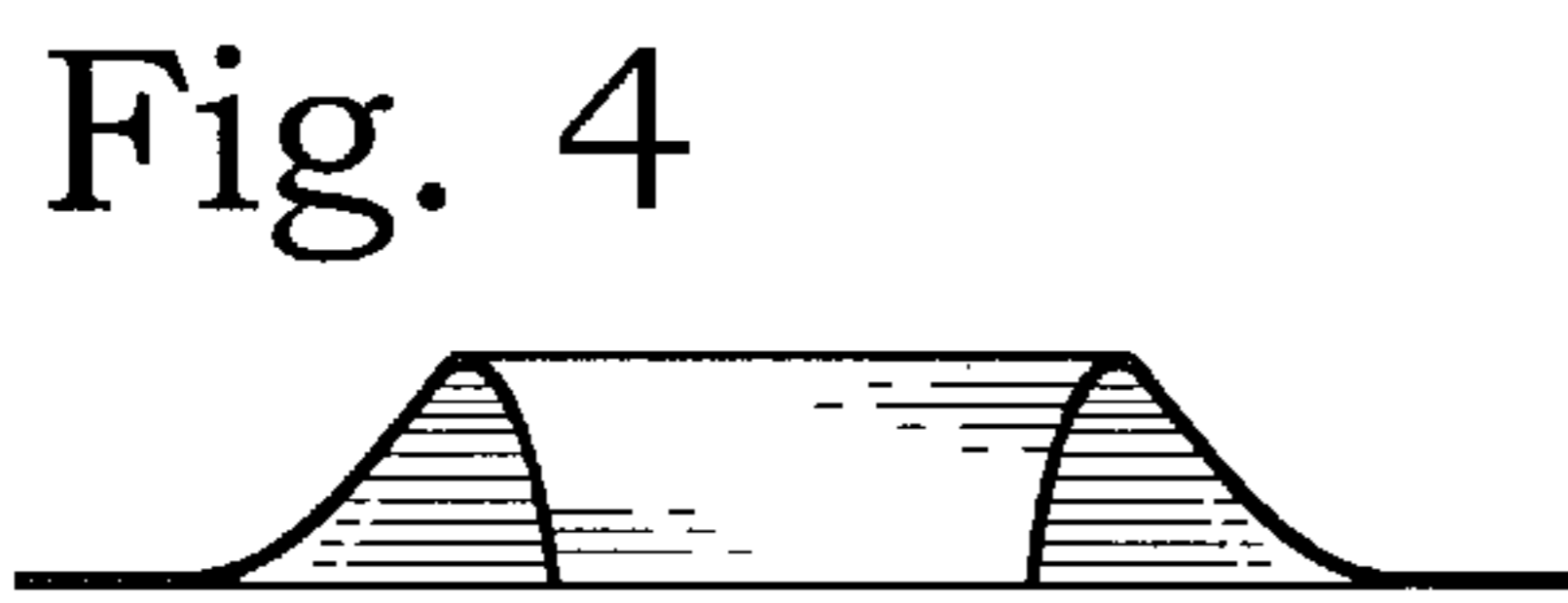
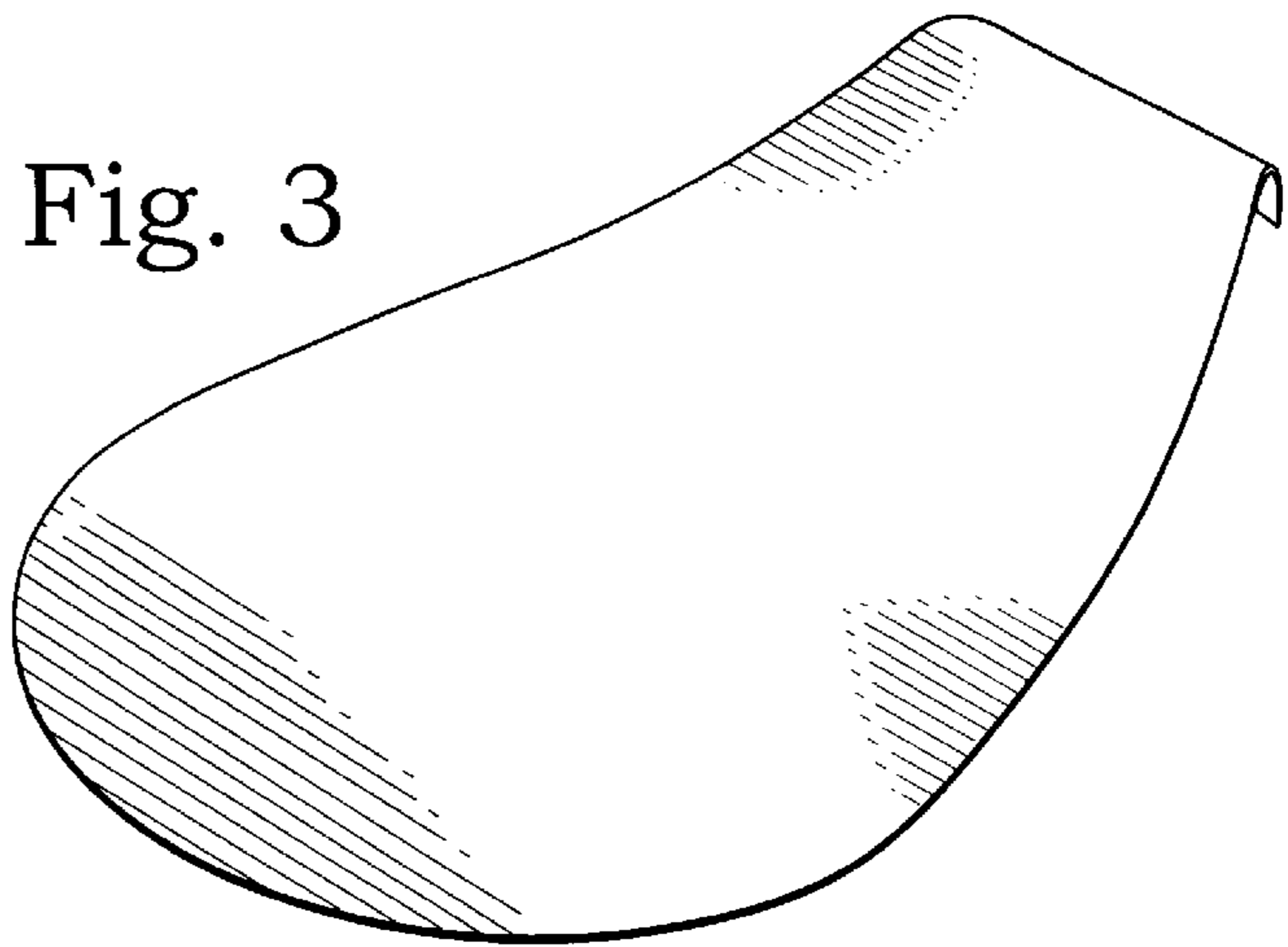
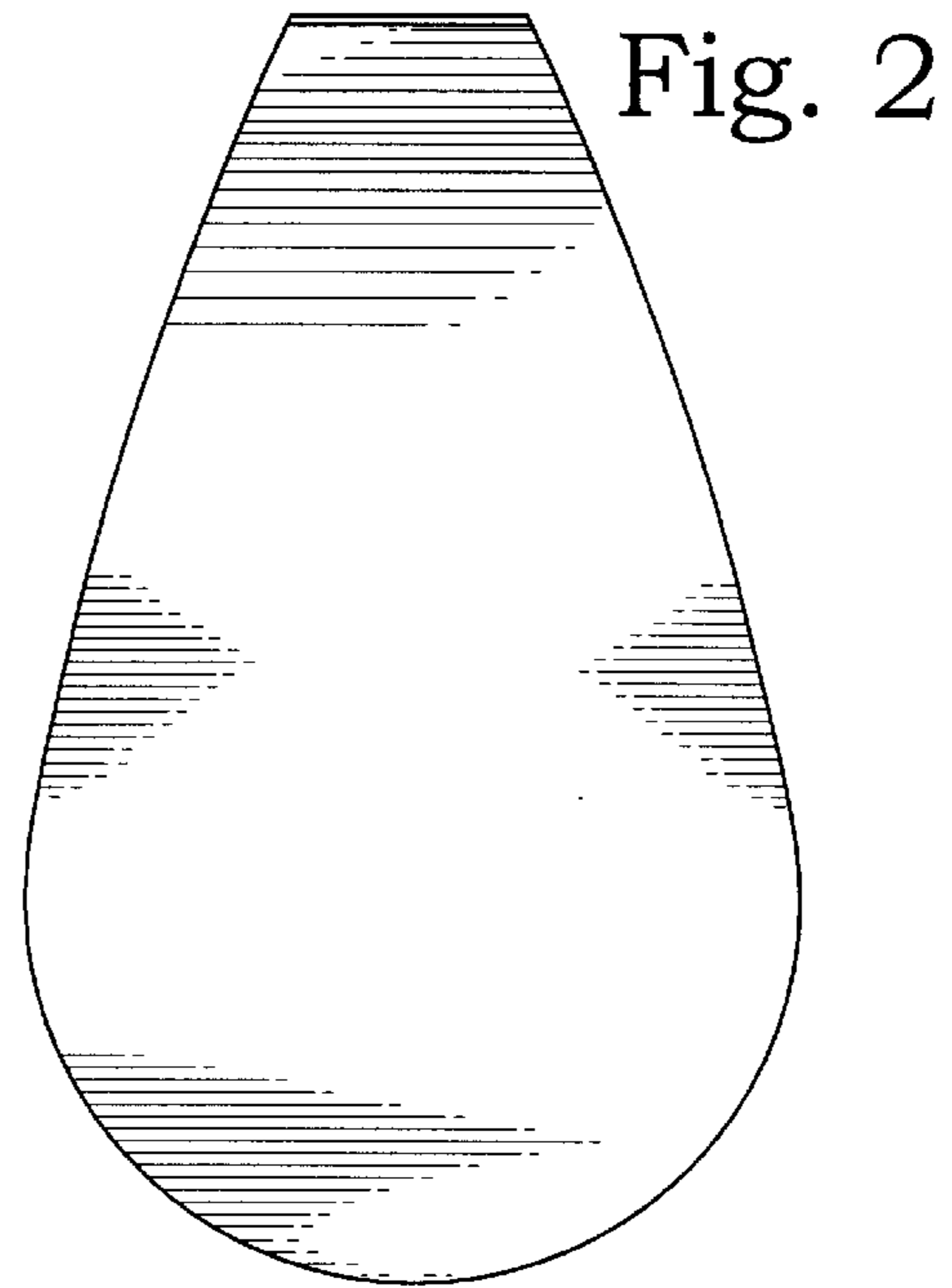
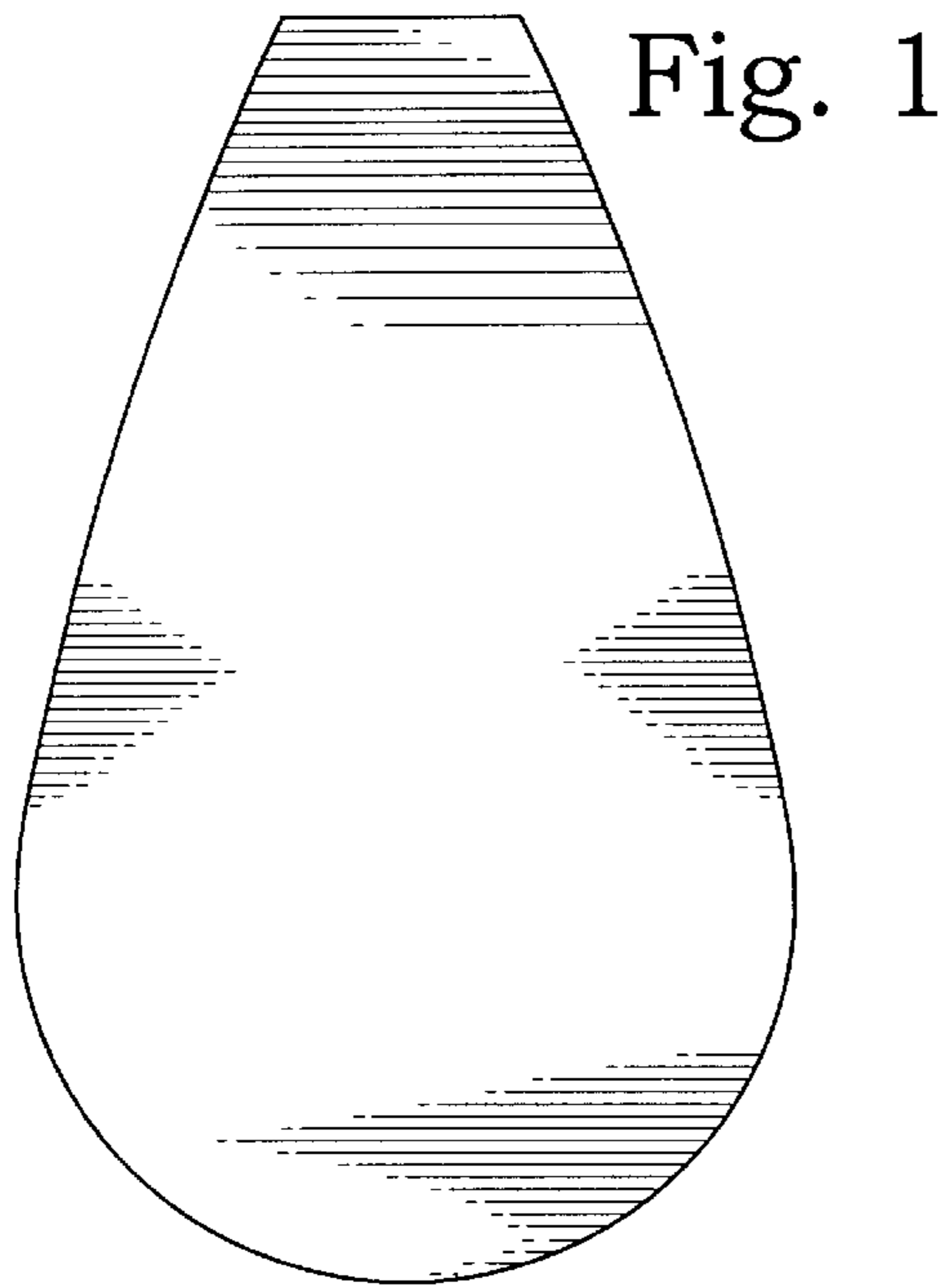

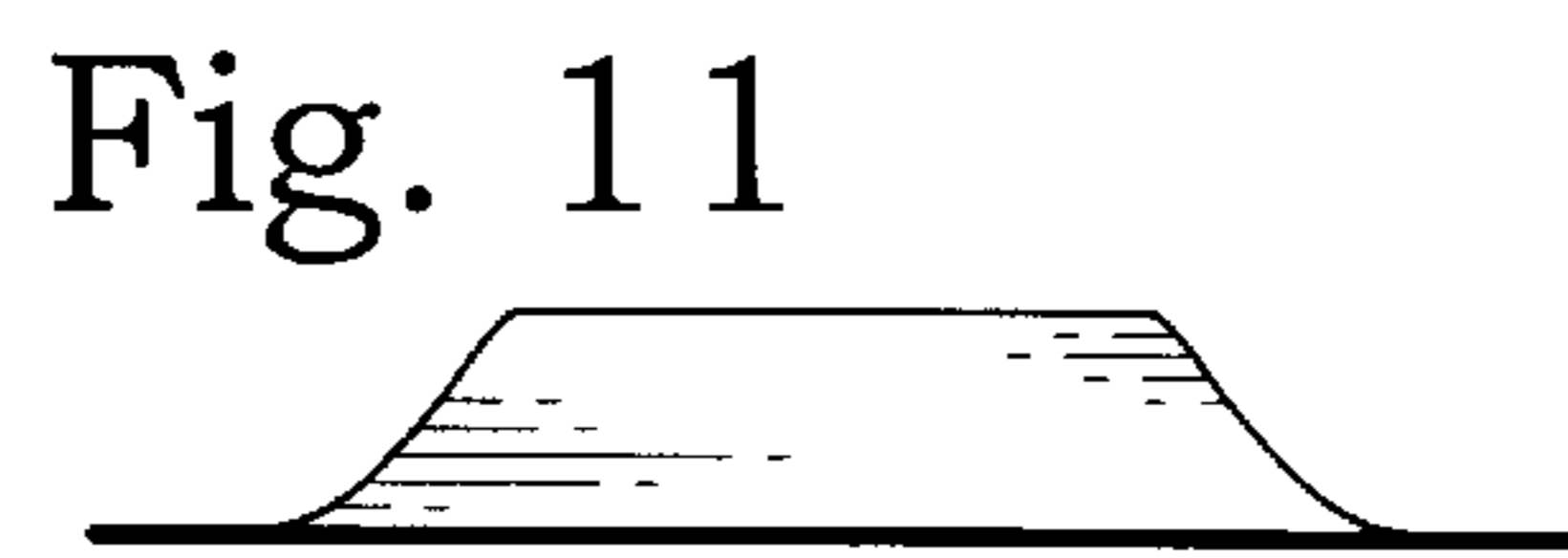
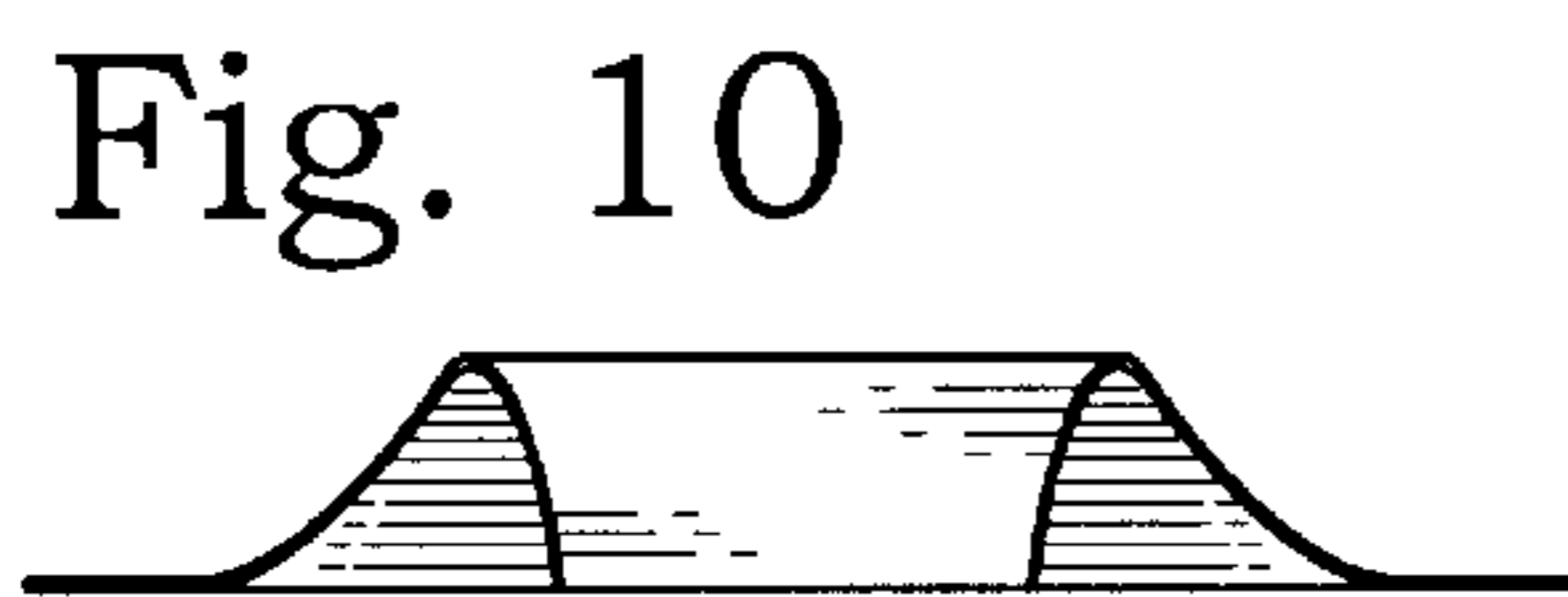
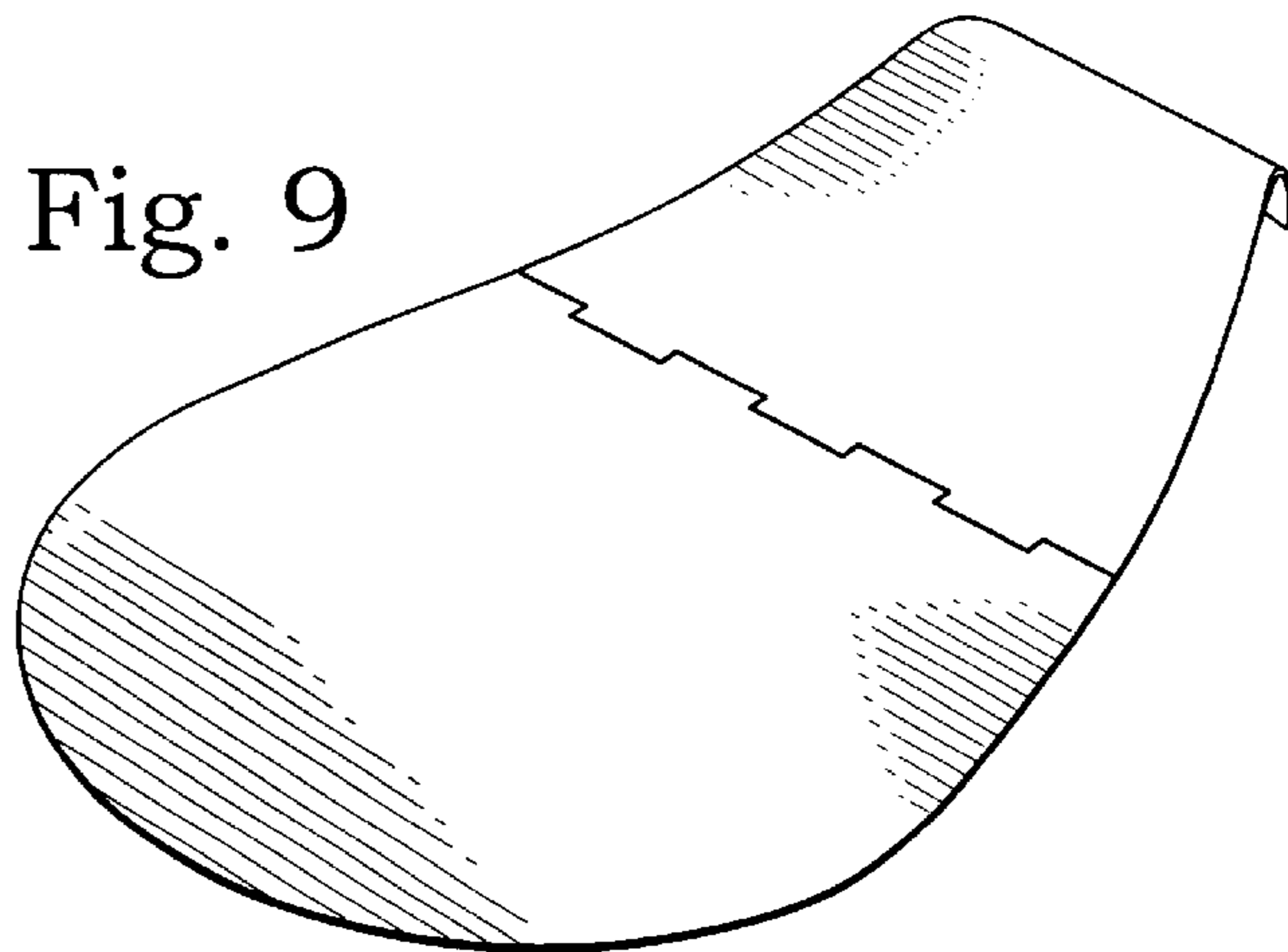
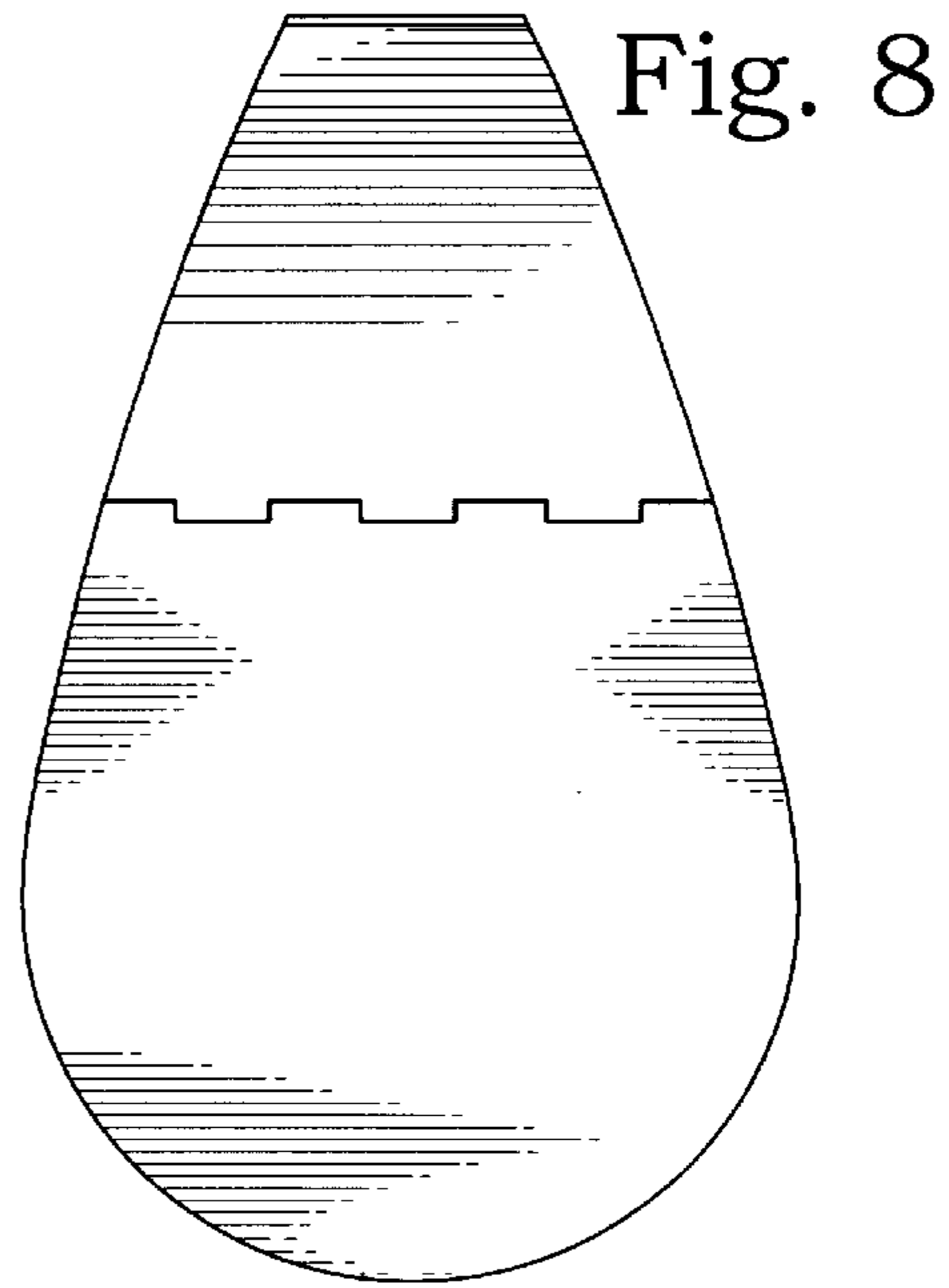
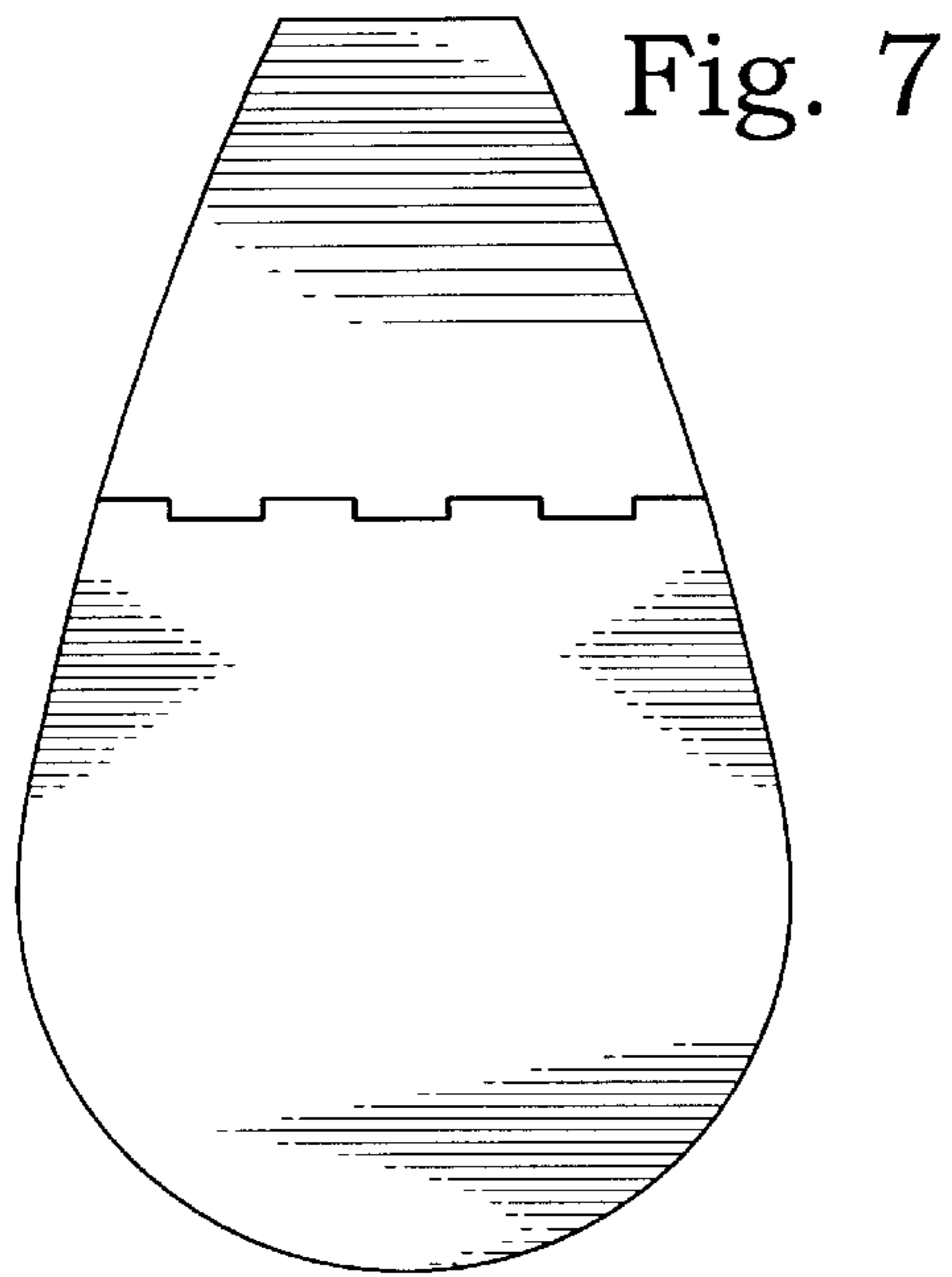

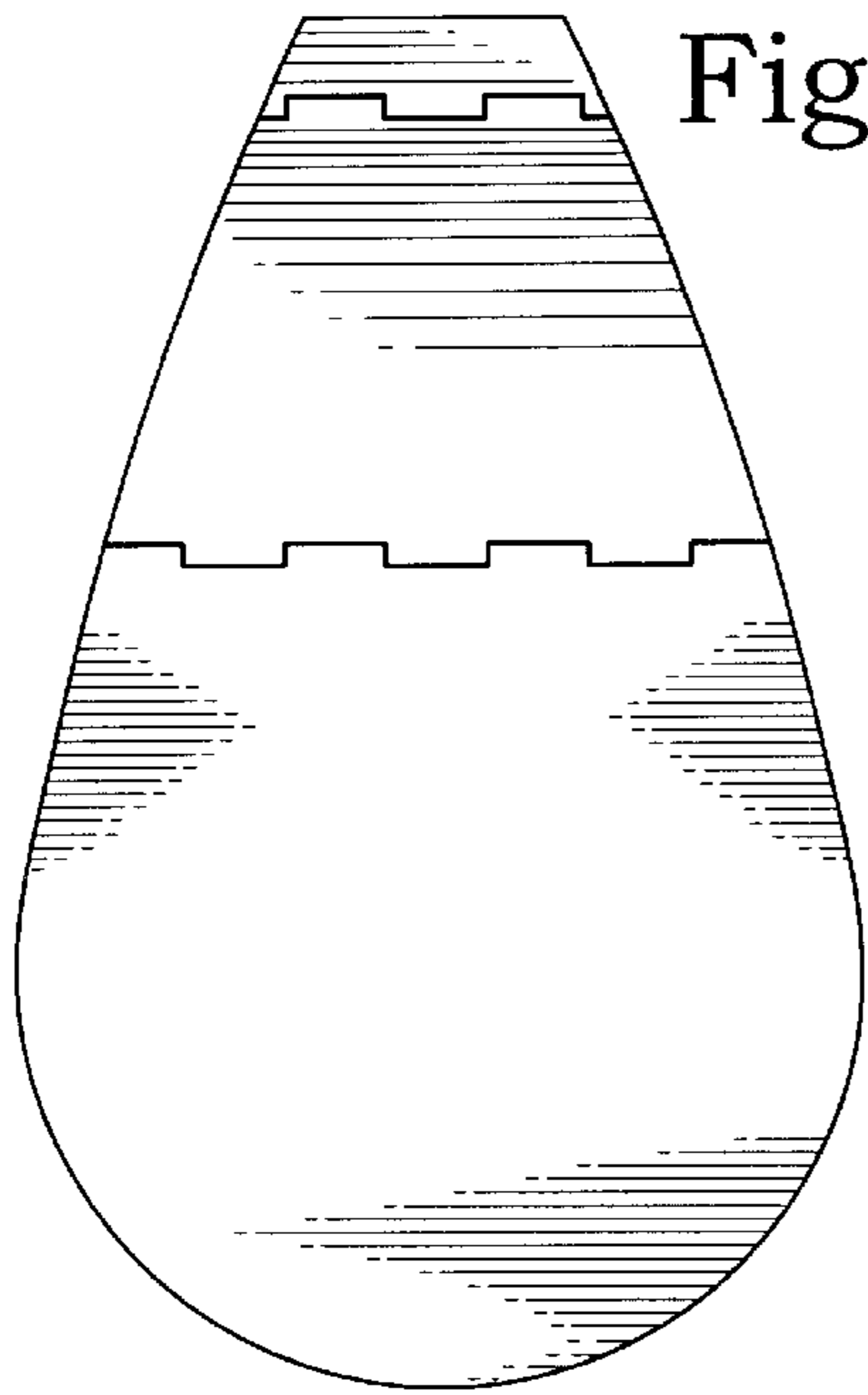

Fig. 13

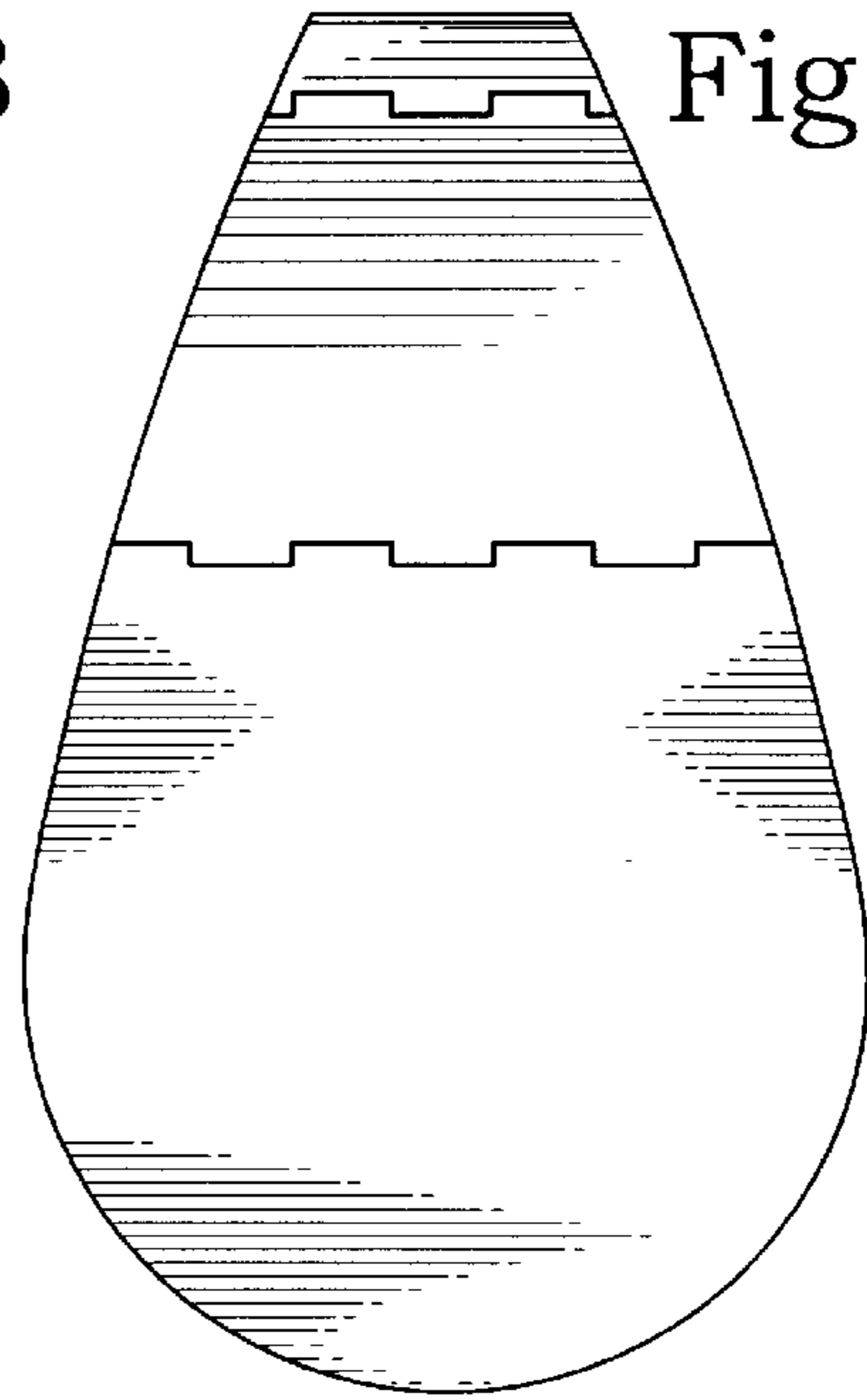

Fig. 14

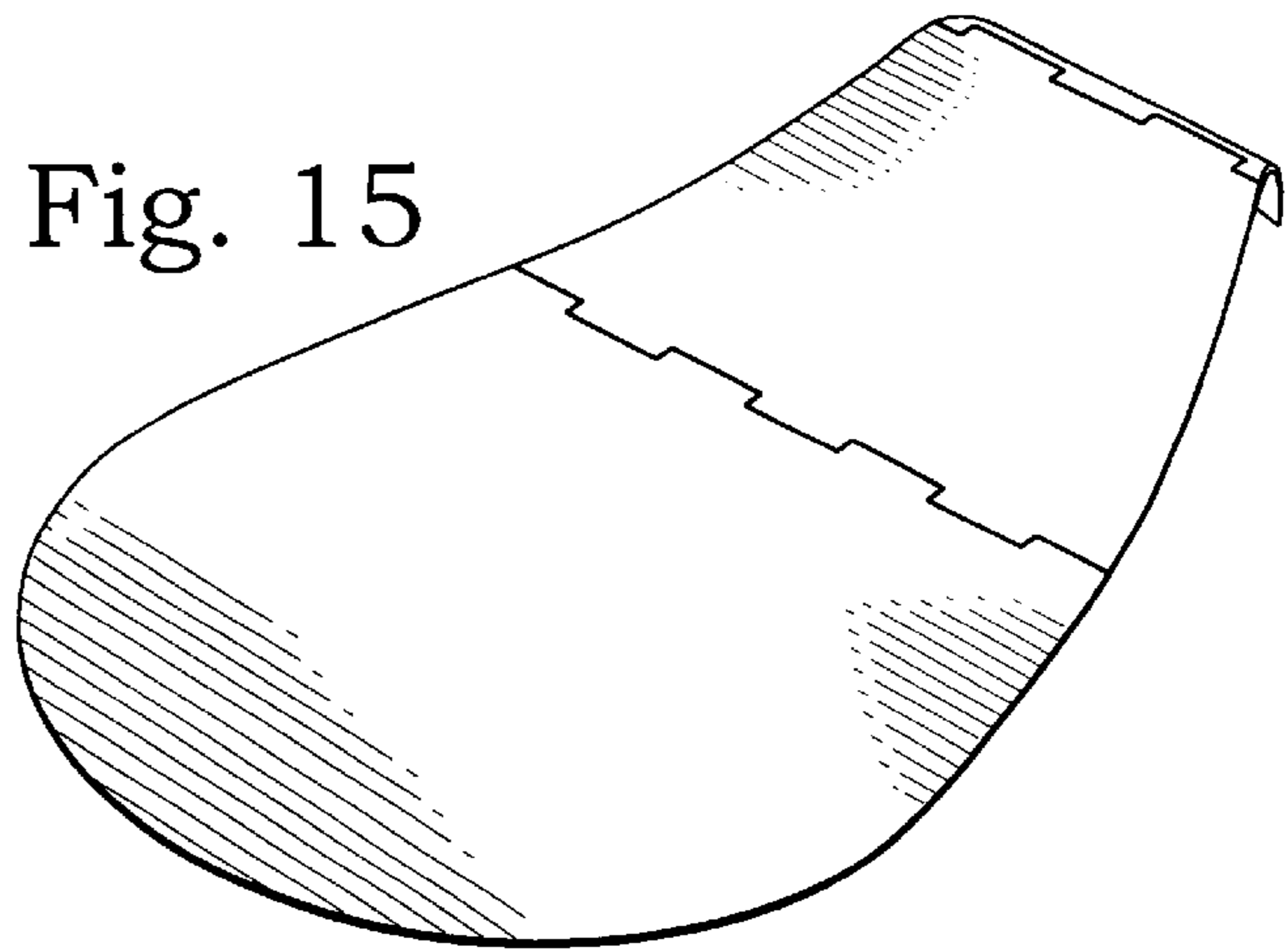

Fig. 15

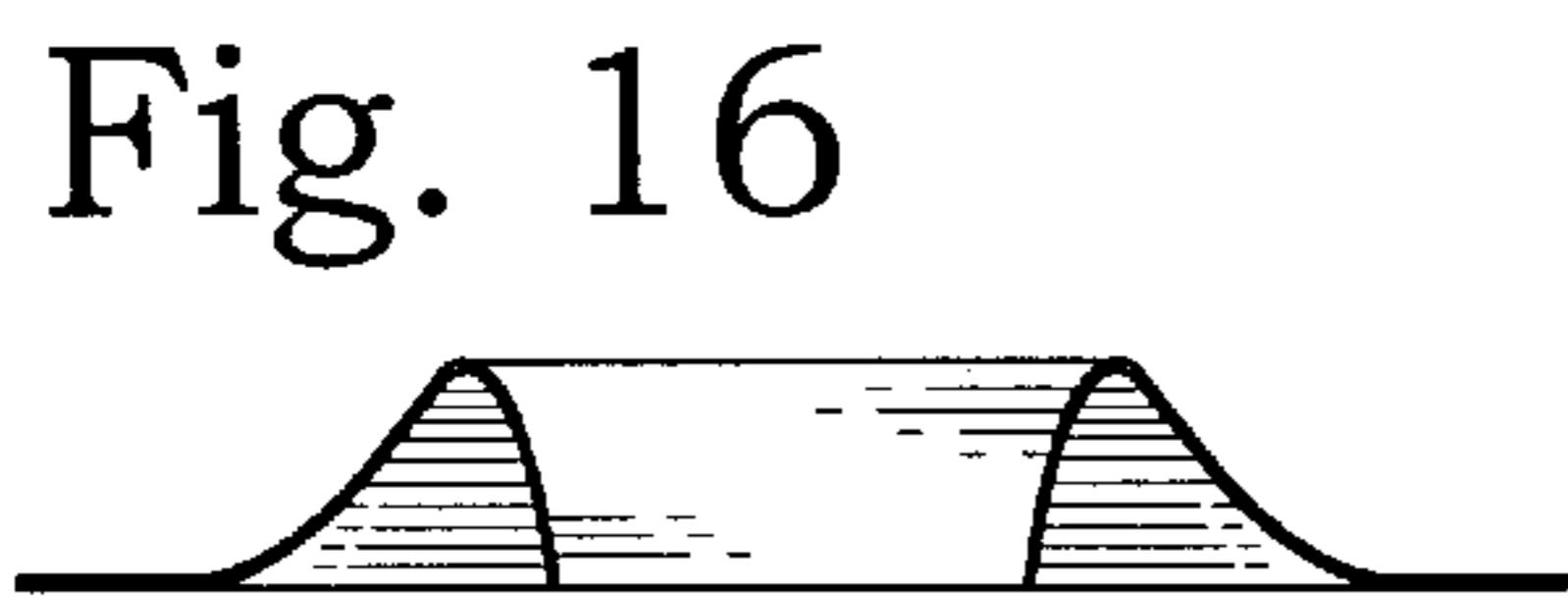

Fig. 16

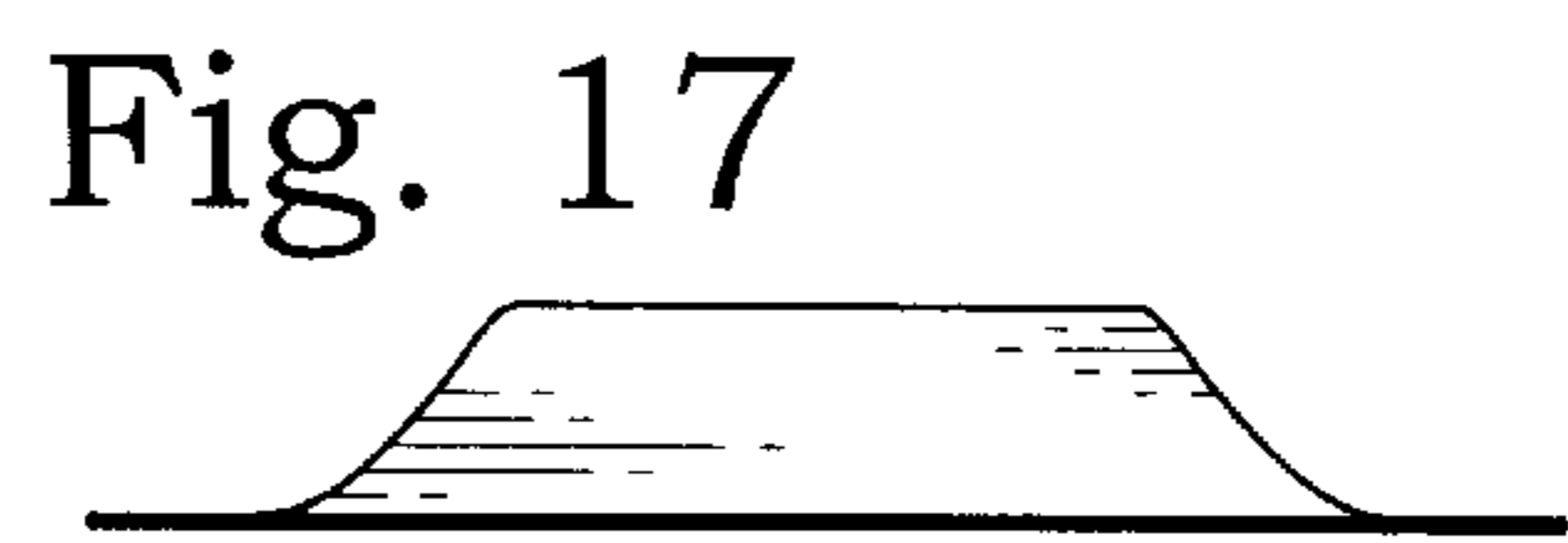

Fig. 17



Fig. 18