



US00D477154S

(12) **United States Design Patent**  
**Benn**

(10) **Patent No.:** **US D477,154 S**

(45) **Date of Patent:** **\*\* Jul. 15, 2003**

(54) **STORAGE CONTAINER**

(75) Inventor: **Alexander Benn**, Stuttgart (DE)

(73) Assignee: **Smead Manufacturing Company**,  
Hastings, MN (US)

(\*\*) Term: **14 Years**

(21) Appl. No.: **29/154,491**

(22) Filed: **Jan. 23, 2002**

(51) **LOC (7) Cl.** ..... **06-04**

(52) **U.S. Cl.** ..... **D6/446; D6/441**

(58) **Field of Search** ..... D6/396, 397, 432,  
D6/433, 436, 440, 441, 444-448, 479, 509,  
510, 511; D3/297; 312/198, 138.1, 204,  
213, 348.4

(56) **References Cited**

**U.S. PATENT DOCUMENTS**

D287,676 S \* 1/1987 Christen ..... D6/446  
D323,082 S \* 1/1992 Rones ..... D6/446  
D370,572 S \* 6/1996 Lin ..... D6/446  
D379,880 S \* 6/1997 Stoeckli et al. .... D6/446  
D402,529 S \* 12/1998 Husted ..... D8/313  
D415,906 S \* 11/1999 D'Agaro et al. .... D6/446  
D424,328 S \* 5/2000 Dominik ..... D6/445

D448,168 S \* 9/2001 Johnston ..... D3/297  
D458,780 S \* 6/2002 Siepmann et al. .... D6/510

\* cited by examiner

*Primary Examiner*—Cathron C. Brooks

(74) *Attorney, Agent, or Firm*—Altera Law Group LLC

(57) **CLAIM**

The ornamental design for storage container, as shown and described.

**DESCRIPTION**

FIG. 1 is a perspective view of the storage container with a four-drawer configuration;

FIG. 2 is a perspective view of a second embodiment of the storage container with a six-drawer configuration;

FIG. 3 is a top plan view of the storage containers of FIGS. 1 and 2;

FIG. 4 is a perspective view of a drawer, shown separately for completeness of illustration;

FIG. 5 is a top plan view of the drawer of FIG. 4;

FIG. 6 is a bottom plan view of the drawer of FIG. 4; and,

FIG. 7 is a side elevational view of the drawer of FIG. 4.

The broken lines shown are for illustrative purposes only and form no part of the claimed design.

**1 Claim, 4 Drawing Sheets**

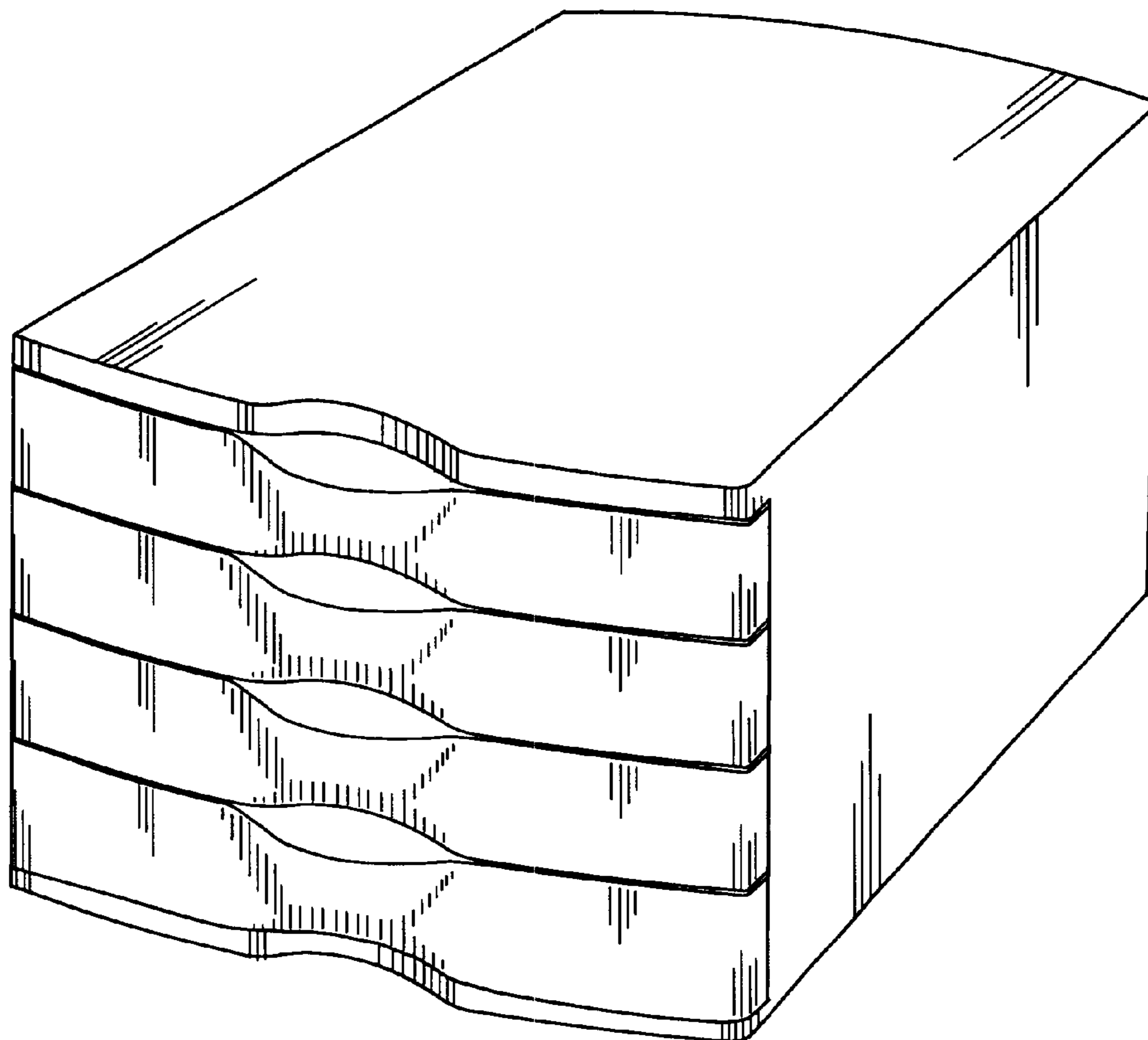

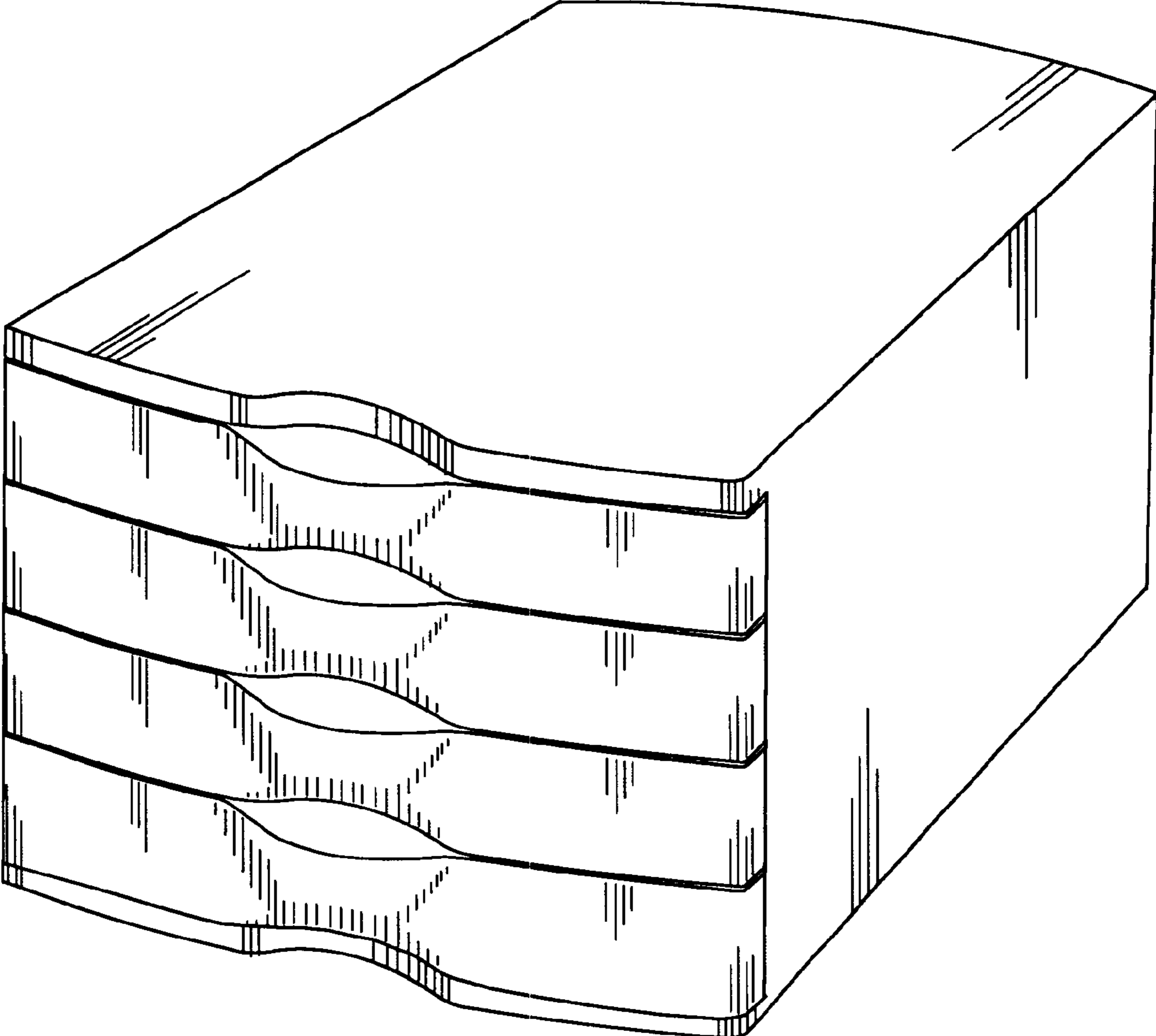

Fig. 1

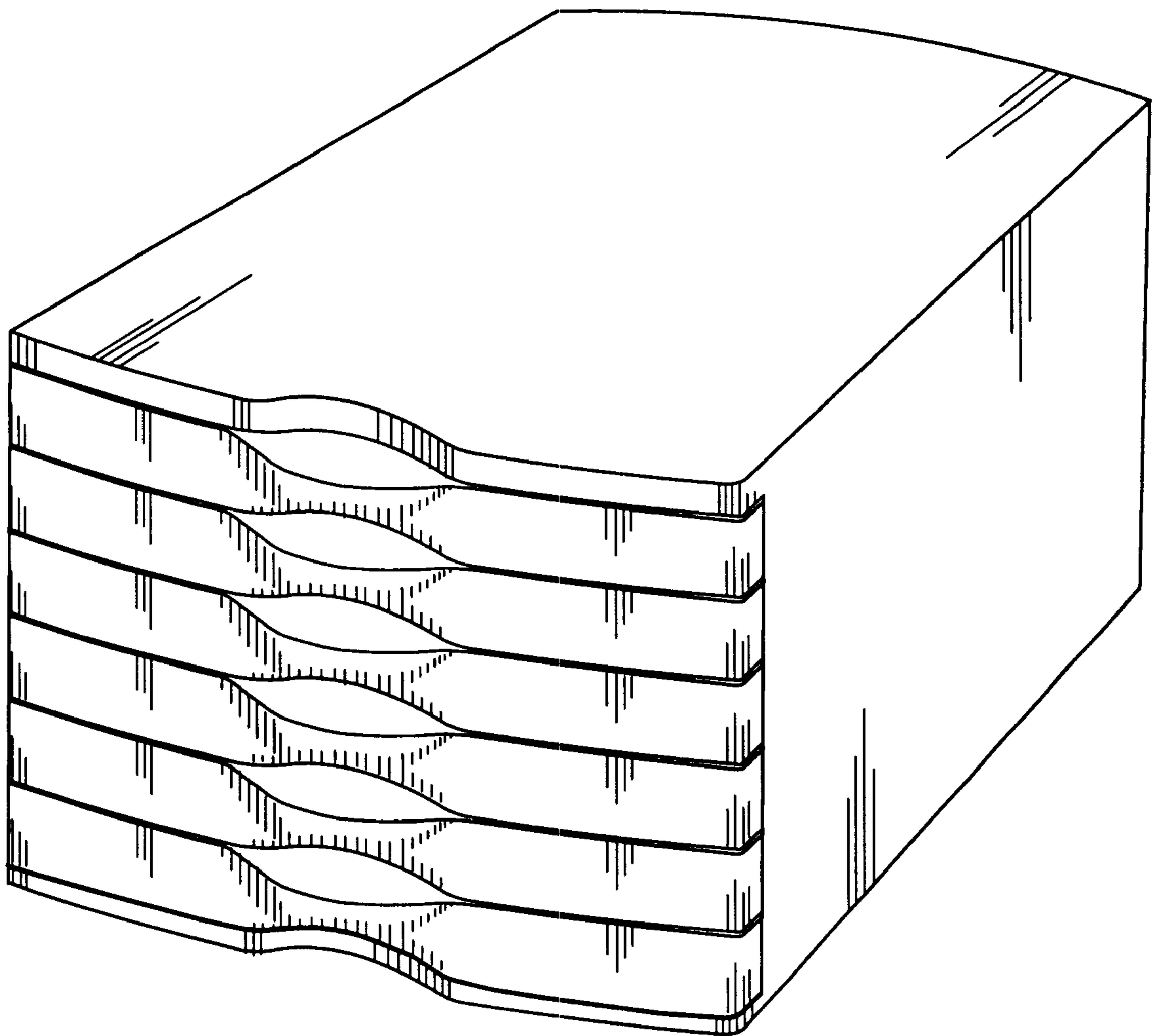

Fig.2

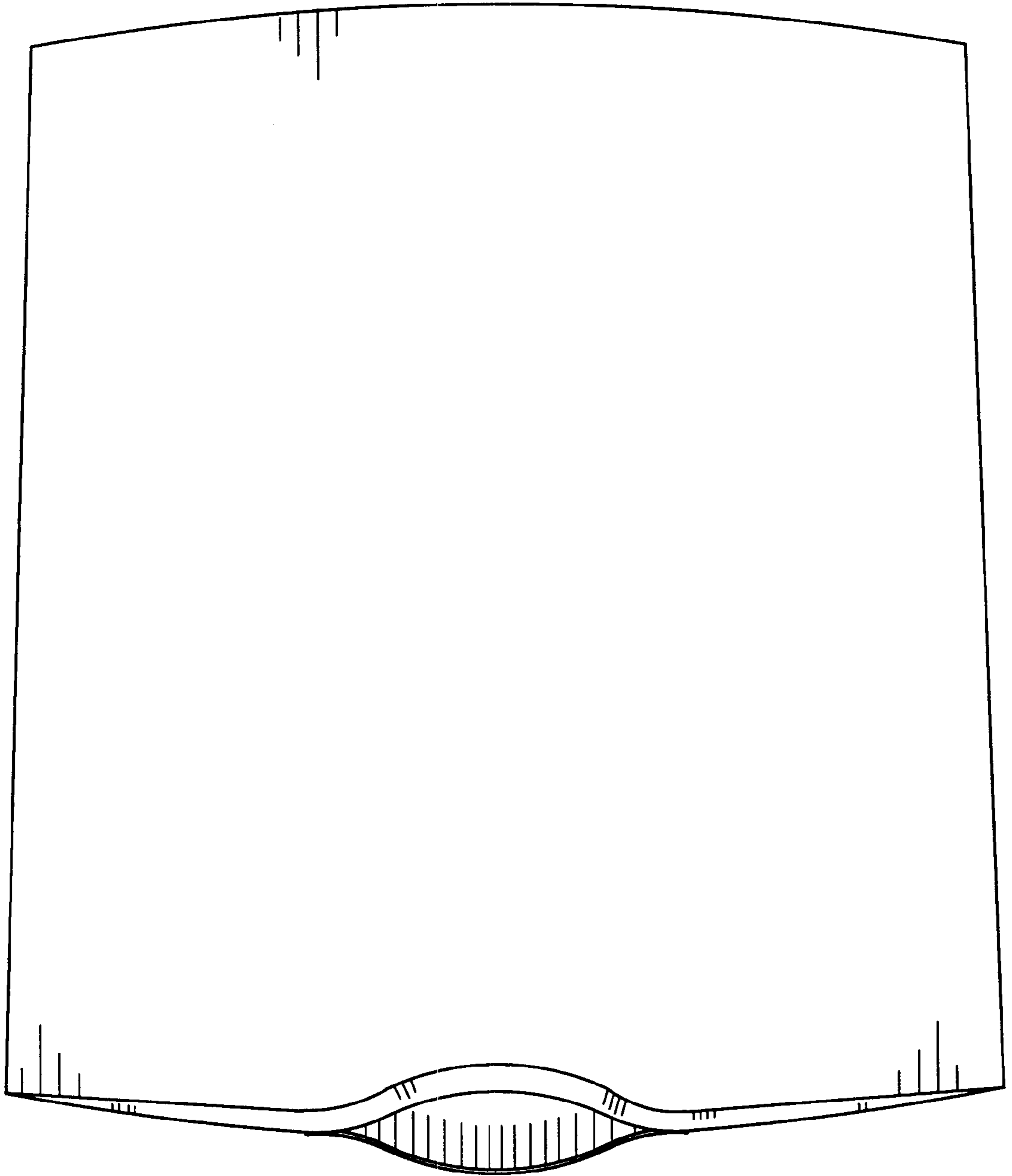

Fig. 3

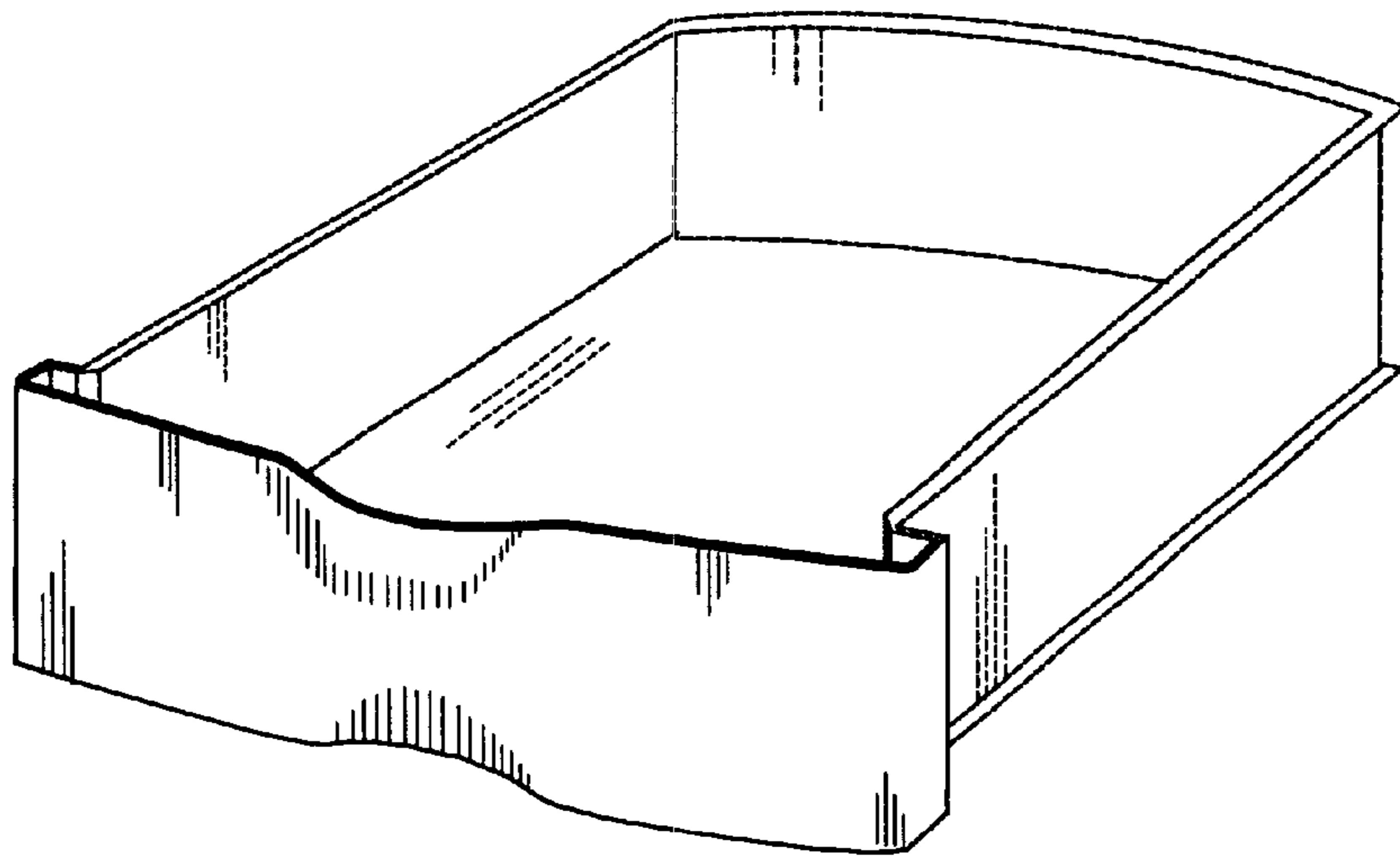

Fig. 4

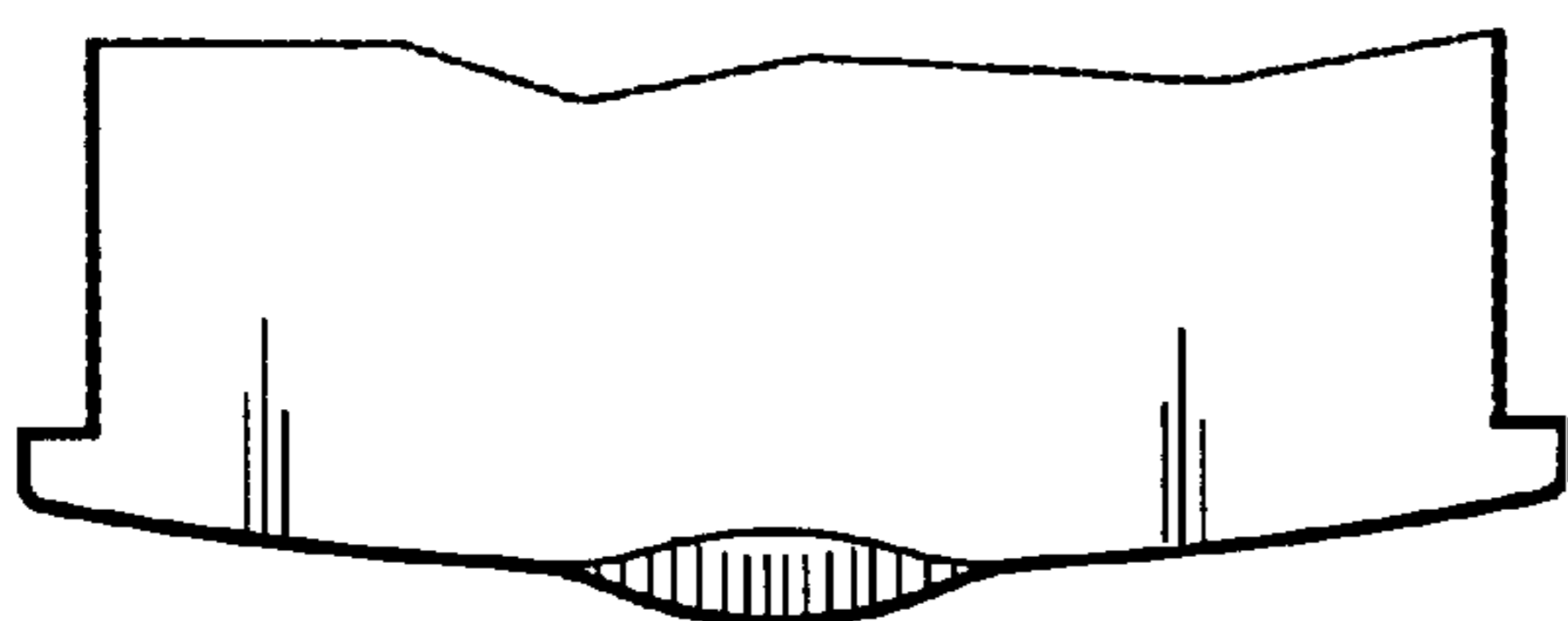

Fig. 5

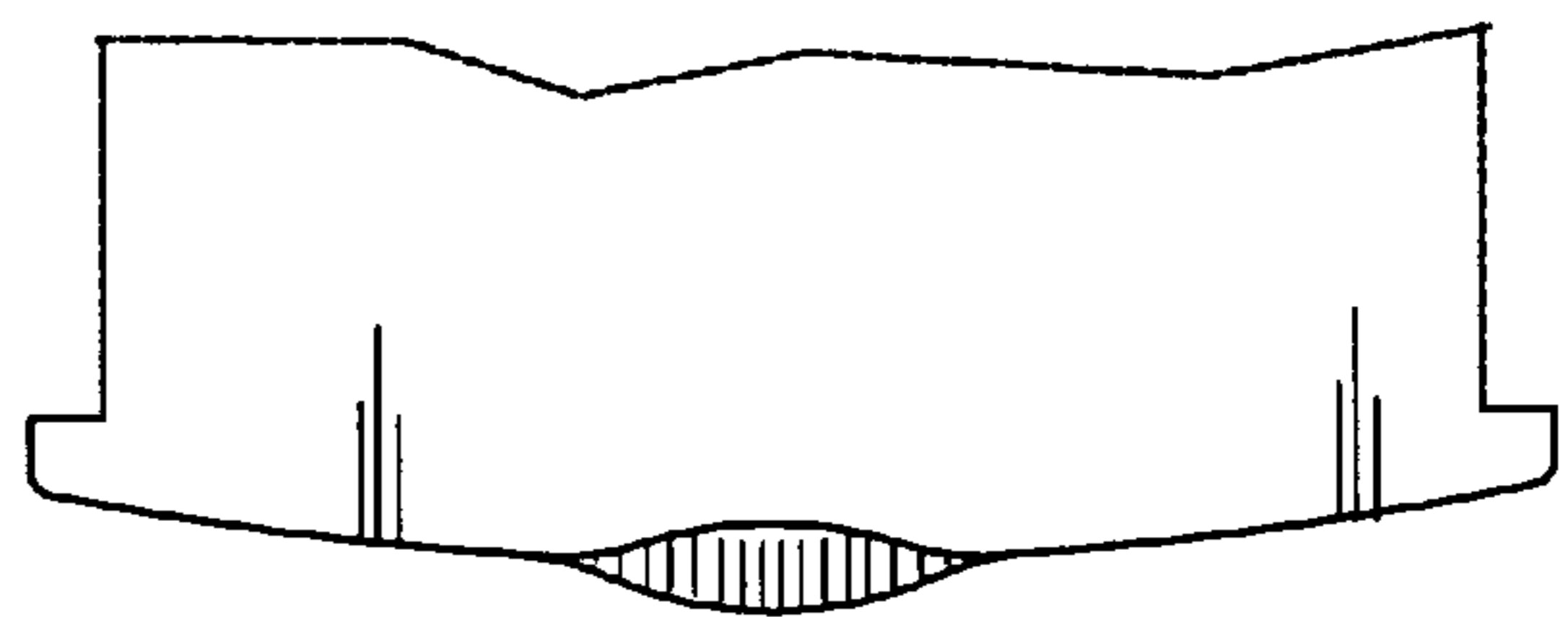

Fig. 6

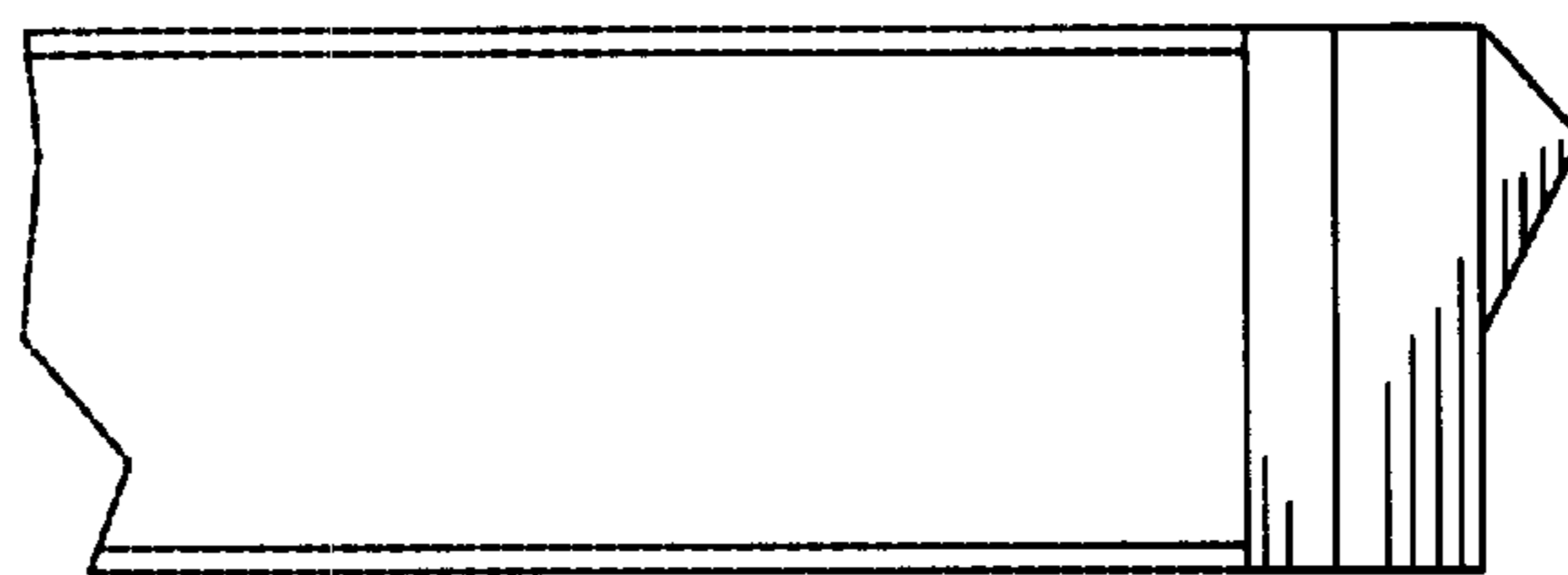

Fig. 7