



US00D477067S

(12) **United States Design Patent**
Lonczak et al.

(10) **Patent No.:** **US D477,067 S**

(45) **Date of Patent:** **** Jul. 8, 2003**

(54) **ELECTRIC LIQUID VAPORIZER**

(75) Inventors: **John Lonczak**, Newburgh, NY (US);
Lawrence T. Levine, Easton, CT (US);
Jonathan Poppick, Fairfield, CT (US);
Rohit Kichlu, Stamford, CT (US)

(73) Assignee: **Blyth, Inc.**, Greenwich, CT (US)

(**) Term: **14 Years**

(21) Appl. No.: **29/168,155**

(22) Filed: **Sep. 26, 2002**

(51) **LOC (7) Cl.** **23-04**

(52) **U.S. Cl.** **D23/367**

(58) **Field of Search** D23/366-9; 422/120,
422/122-4; 239/211, 34-60; 261/DIG. 65

(56) **References Cited**

U.S. PATENT DOCUMENTS

- D379,651 S * 6/1997 Rondeau
- D379,652 S * 6/1997 Okamoto
- D381,443 S * 7/1997 Yuen
- D390,941 S * 2/1998 Cessaroni et al.
- 5,725,152 A * 3/1998 Akyu

- D395,529 S * 6/1998 Yuen
- D422,350 S * 4/2000 Wu
- D430,659 S * 9/2000 Zaragoza et al.
- D464,416 S * 10/2002 von Dohlen et al.
- D471,267 S * 3/2003 Ahn et al.

* cited by examiner

Primary Examiner—M. H. Tung

(74) *Attorney, Agent, or Firm*—Marshall, Gerstein & Borun

(57) **CLAIM**

The ornamental design for an “electric liquid vaporizer”, as shown and described.

DESCRIPTION

FIG. 1 is a left side perspective view taken from the front and above showing our new design;
 FIG. 2 is a left elevational view thereof;
 FIG. 3 is a right elevational view thereof;
 FIG. 4 is a front view thereof;
 FIG. 5 is a rear view thereof;
 FIG. 6 is a plan view thereof; and,
 FIG. 7 is a bottom view thereof.

The broken line showing an electrical prong is for illustrative purposes only and forms no part of the claimed design.

1 Claim, 4 Drawing Sheets

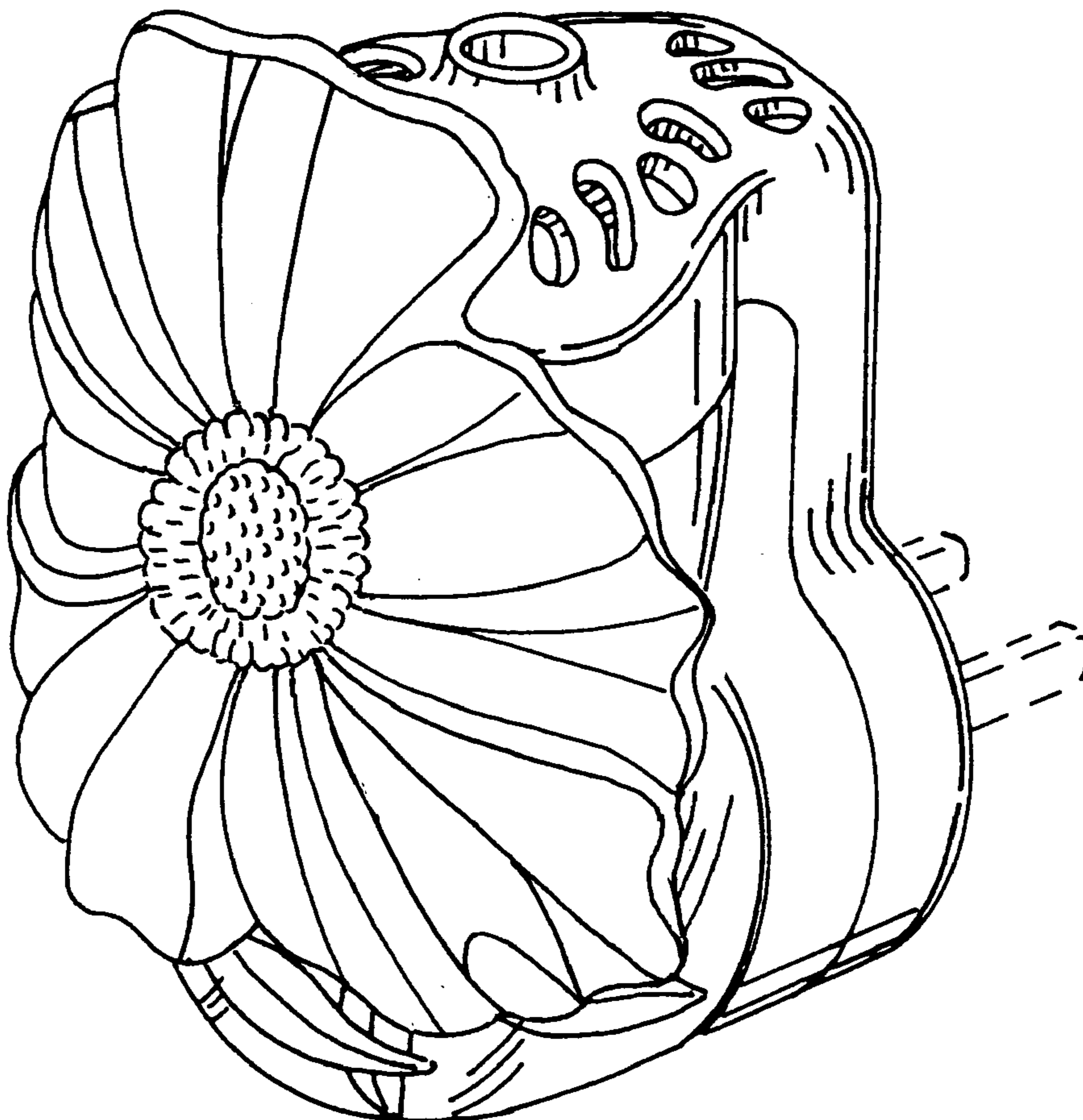

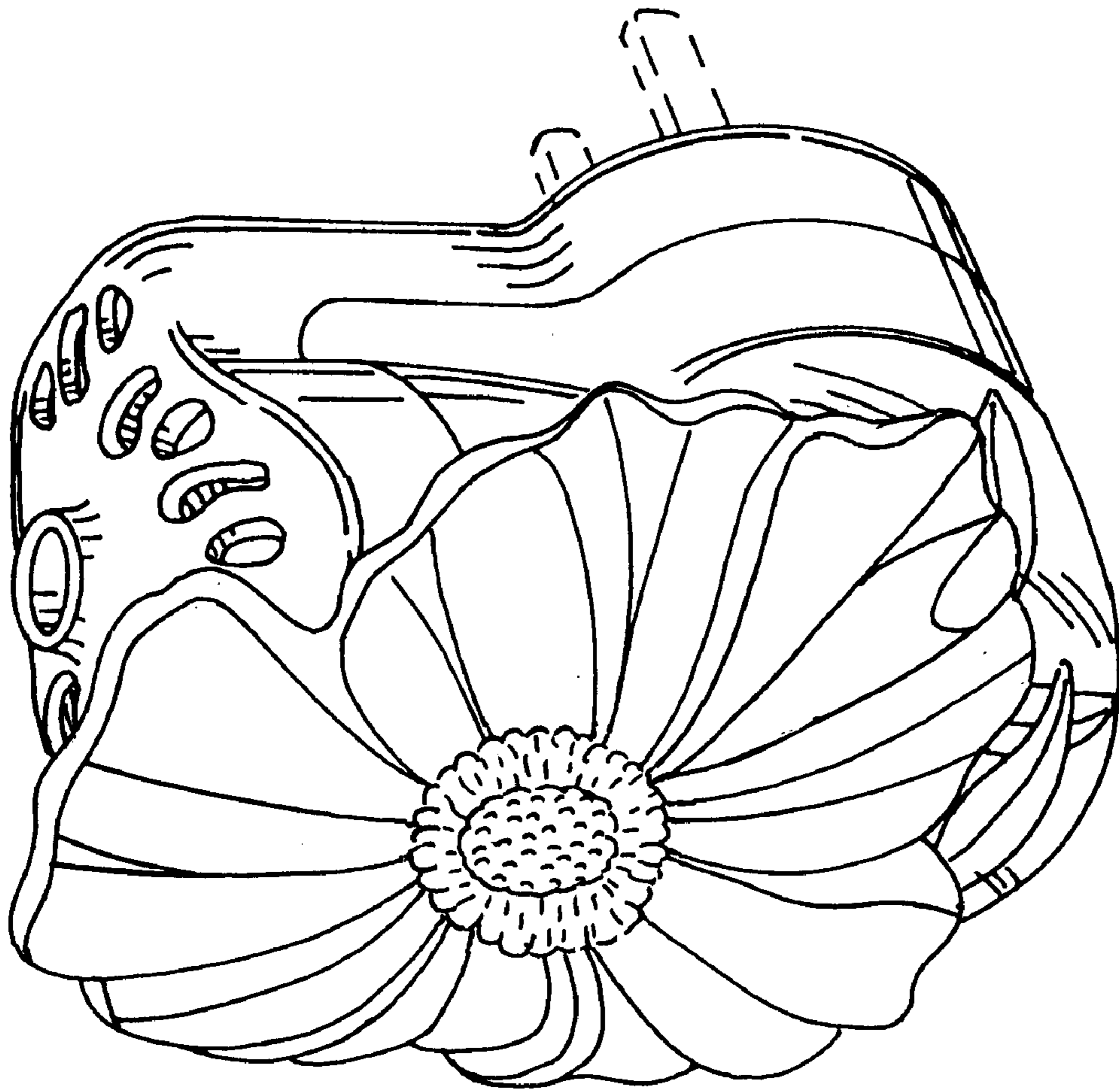

FIG. 1

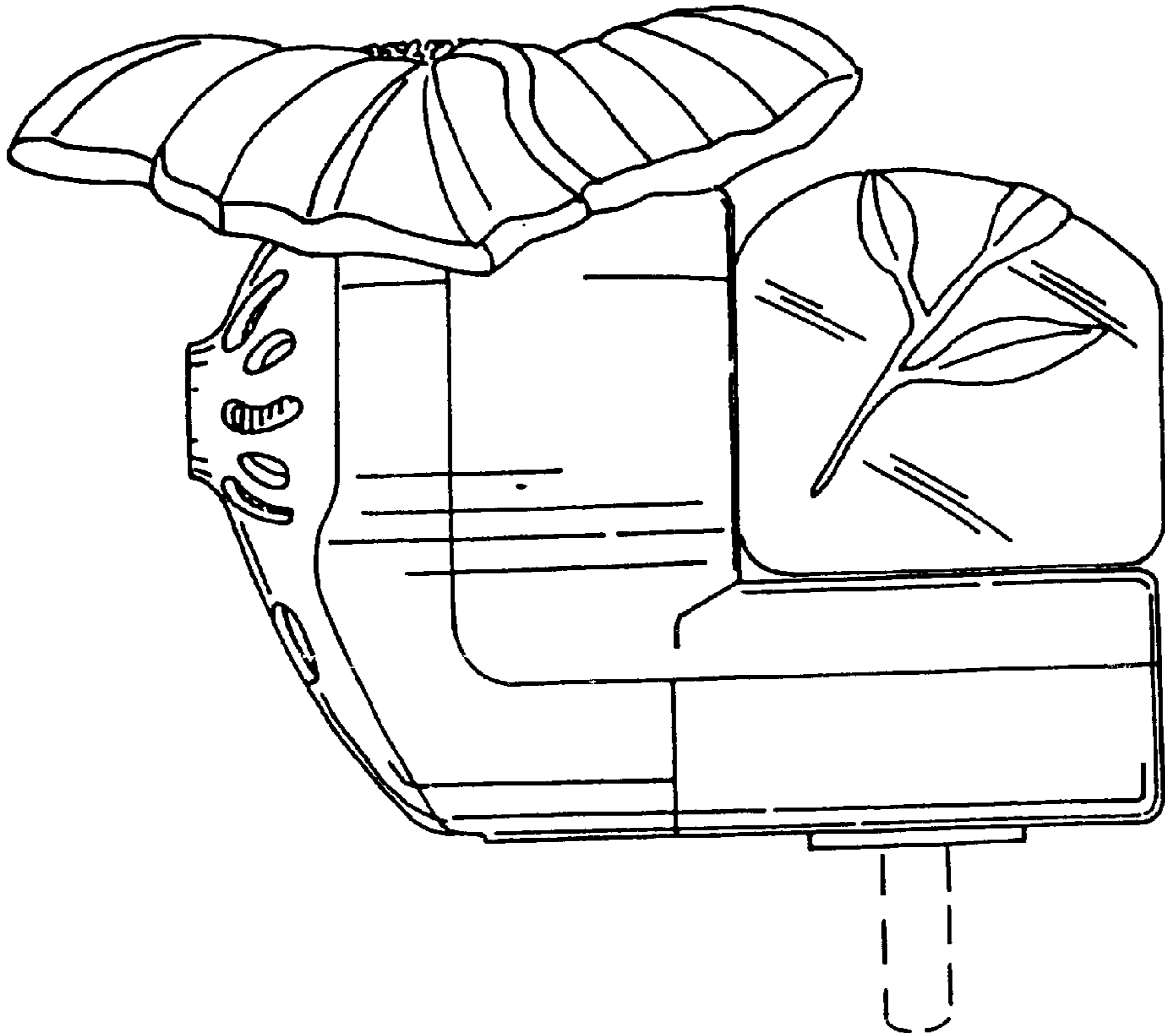

FIG. 2

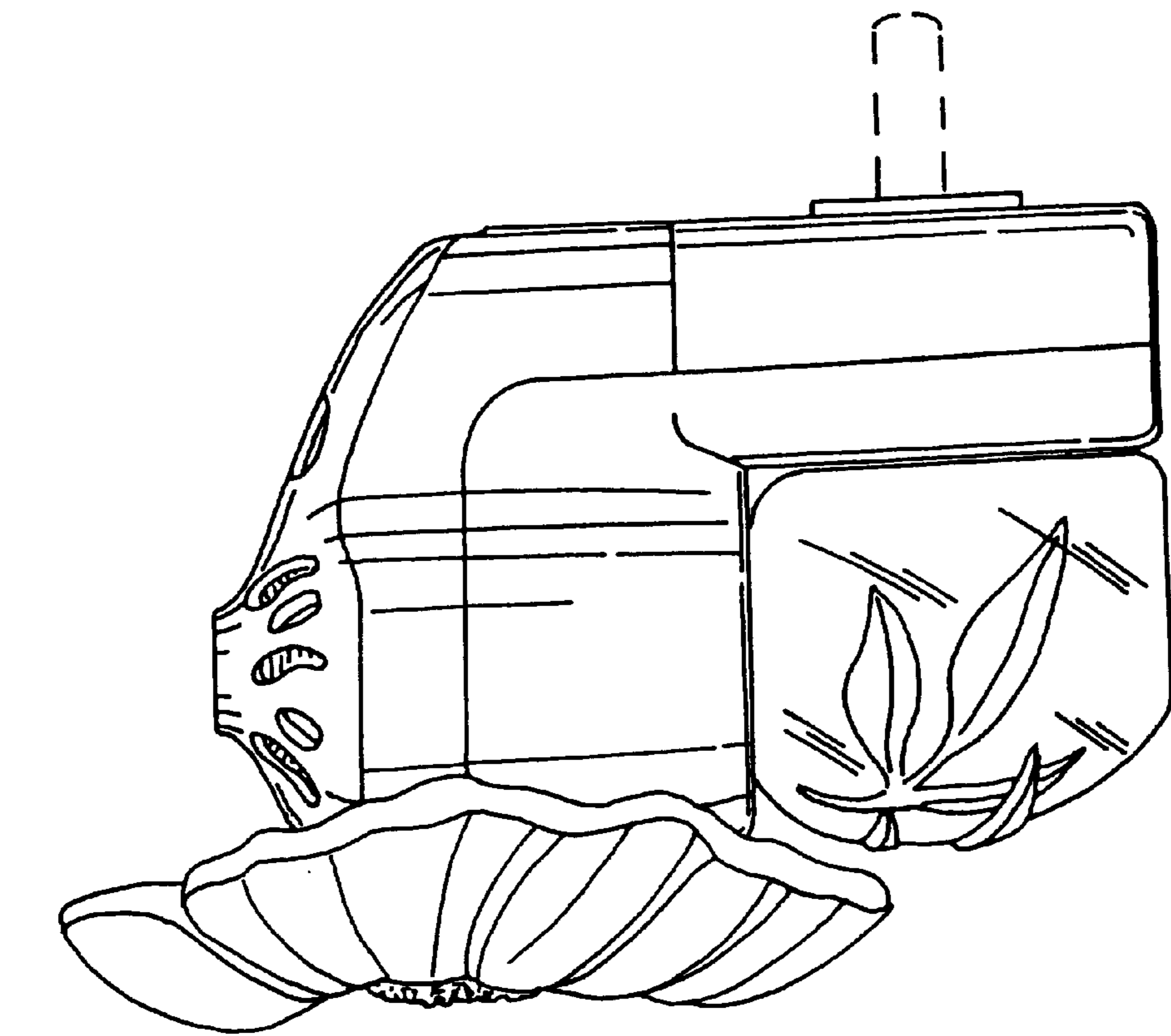

FIG. 3

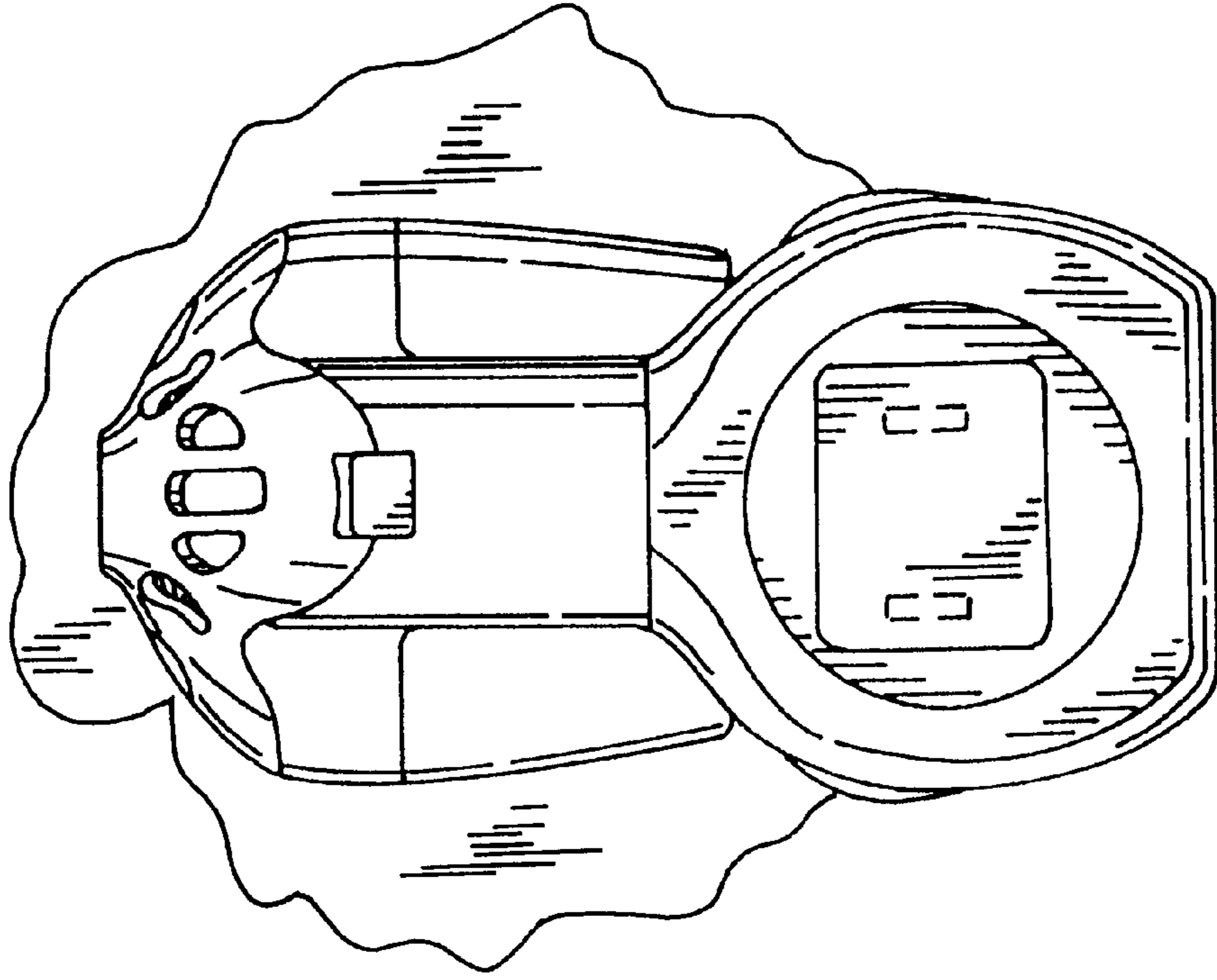

FIG. 5

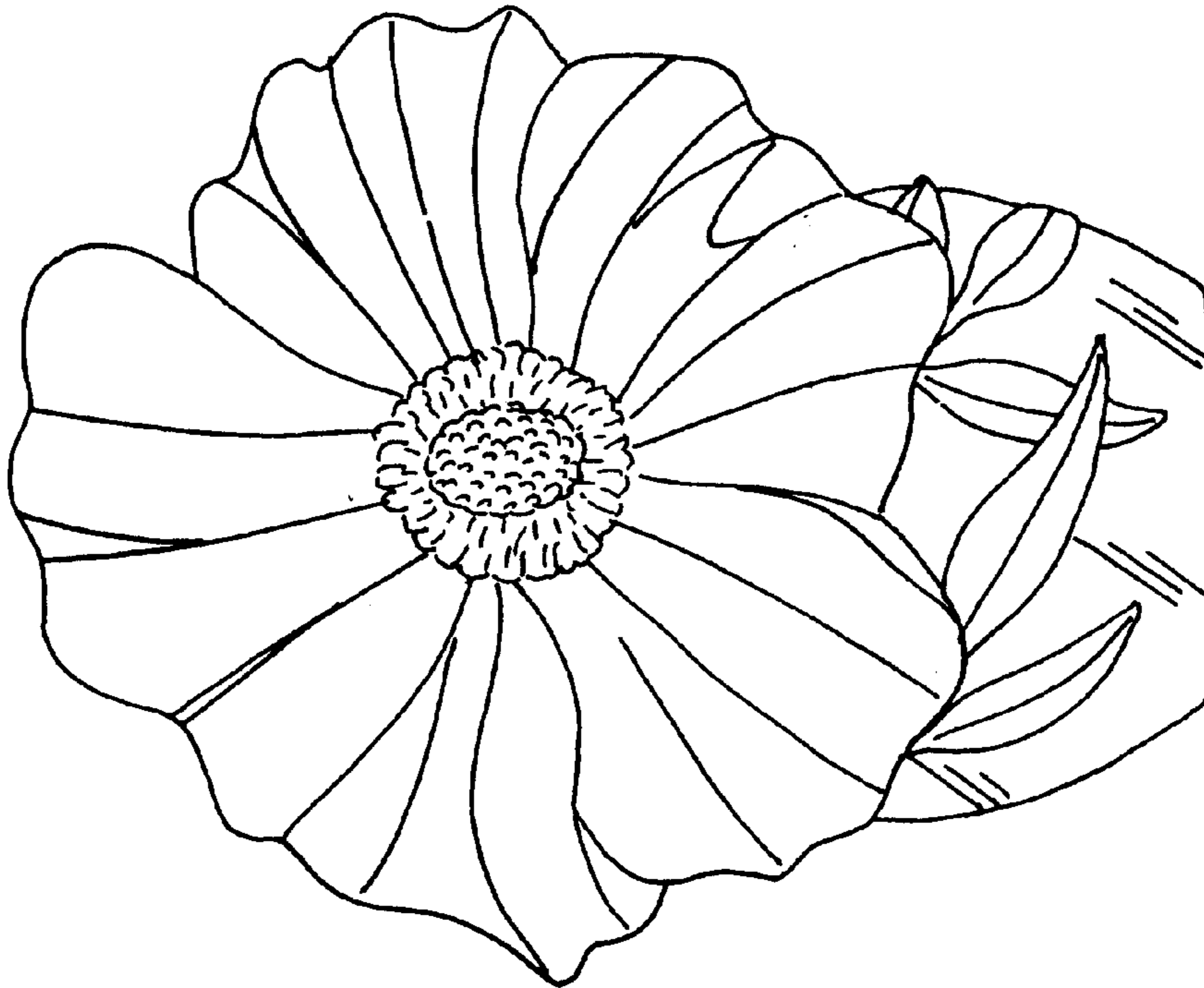

FIG. 4

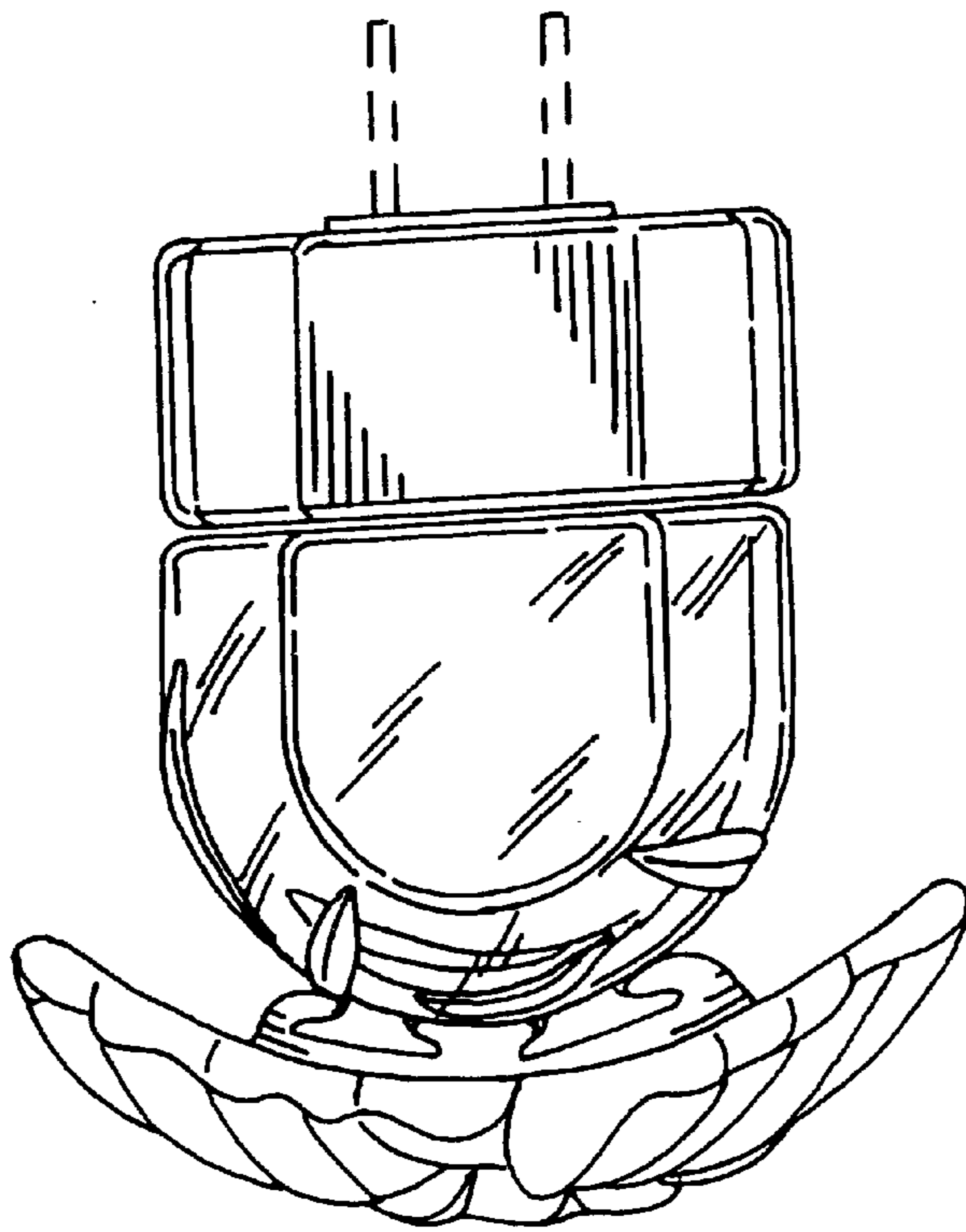

FIG. 7

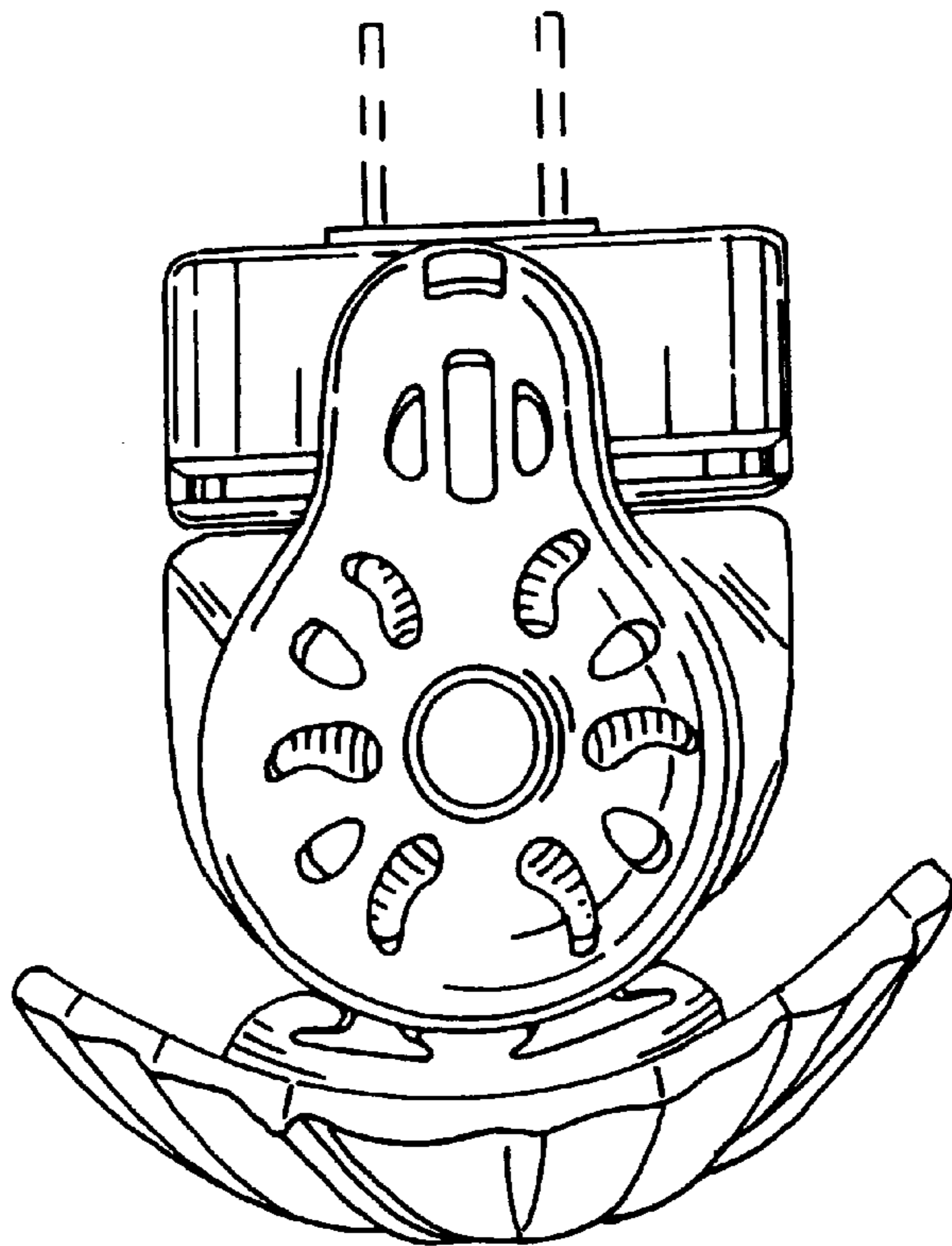

FIG. 6