



US00D477041S

(12) **United States Design Patent**
Cameron

(10) **Patent No.:** **US D477,041 S**

(45) **Date of Patent:** **** Jul. 8, 2003**

(54) **PUTTER HEAD**

D422,328 S * 4/2000 Lannoch D21/743
D465,819 S * 11/2002 Bussiere D21/736

(75) Inventor: **Don T. Cameron**, Carlsbad, CA (US)

OTHER PUBLICATIONS

(73) Assignee: **Acushnet Company**, Fairhaven, MA (US)

Utility Co-pending application Ser. No. 10/051,007, filed Jan. 22, 2002.

(**) Term: **14 Years**

* cited by examiner

(21) Appl. No.: **29/164,346**

Primary Examiner—Mitchell Siegel

(22) Filed: **Jul. 23, 2002**

(74) *Attorney, Agent, or Firm*—D. Michael Burns

(51) **LOC (7) Cl.** **21-02**

(52) **U.S. Cl.** **D21/742**

(58) **Field of Search** D21/735, 736–746;
473/324–327, 340, 341, 251–256

(57) **CLAIM**

The ornamental design for a putter head, as shown and described.

(56) **References Cited**

DESCRIPTION

U.S. PATENT DOCUMENTS

4,688,798 A	*	8/1987	Pelz	473/249
D309,765 S	*	8/1990	Pelz	D21/735
D317,962 S	*	7/1991	Pelz	D21/735
D323,688 S	*	2/1992	Whitney	D21/741
D354,535 S	*	1/1995	Queen	D21/743
D357,292 S	*	4/1995	Smith	D21/741
D410,055 S	*	5/1999	Loop	D21/736

FIG. 1 is a perspective view of the putter head.
FIG. 2 is a left elevational view thereof.
FIG. 3 is a right elevational view thereof.
FIG. 4 is a front elevational view thereof.
FIG. 5 is a top elevational view thereof.
FIG. 6 is a bottom elevational view thereof; and,
FIG. 7 is a back elevational view thereof.

1 Claim, 3 Drawing Sheets

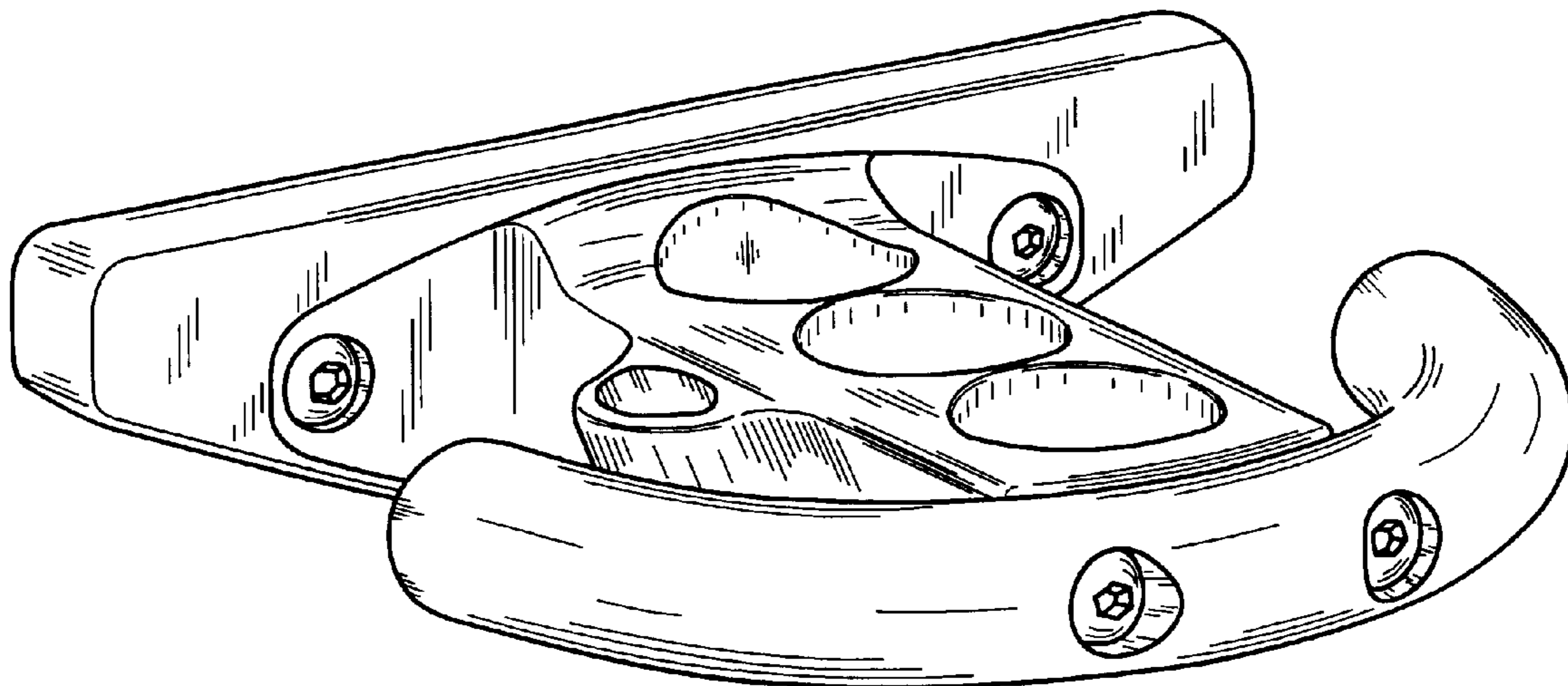

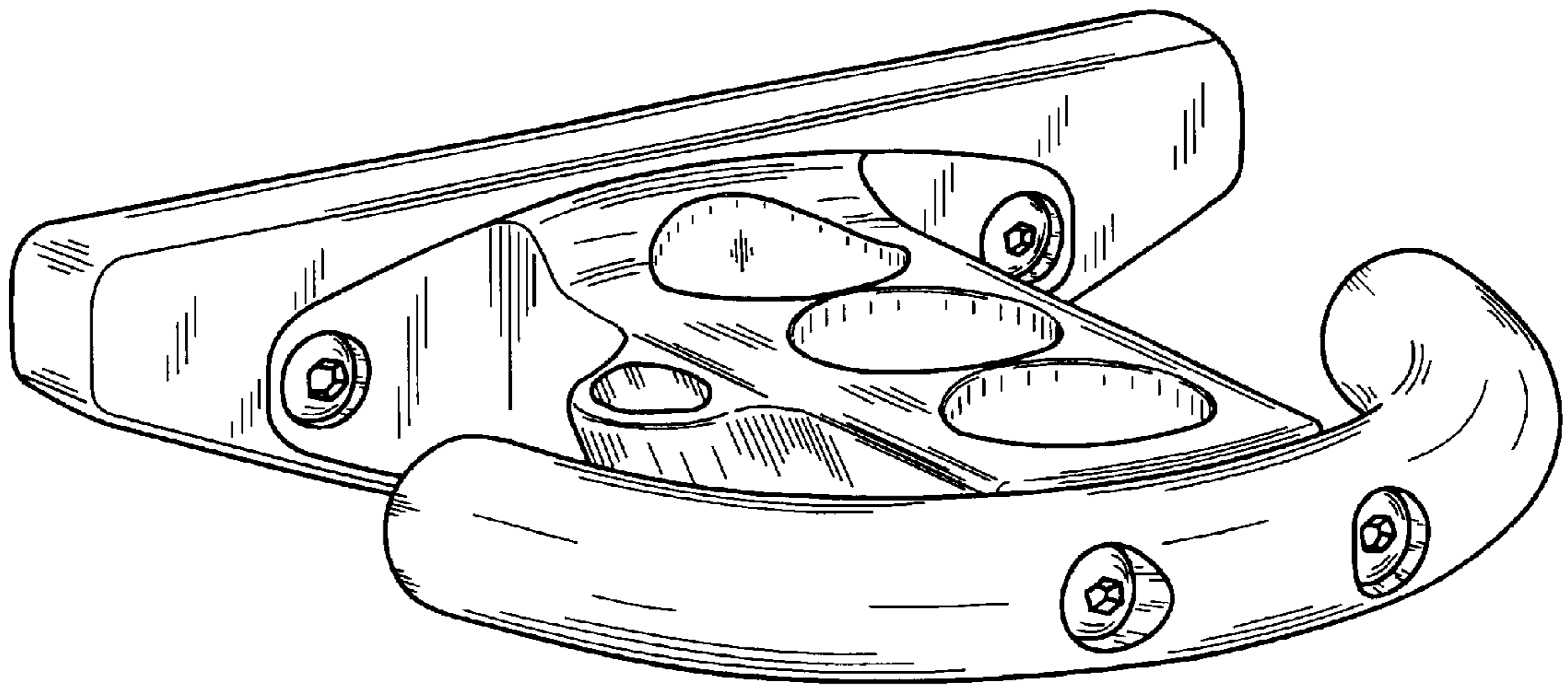

FIG. 1

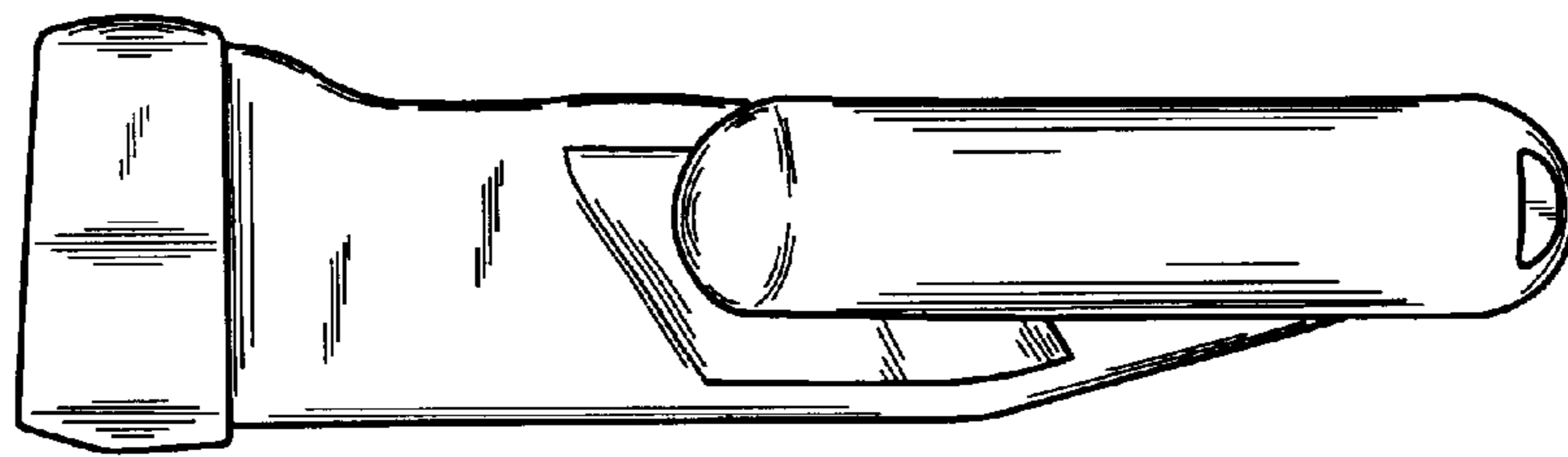

FIG. 2

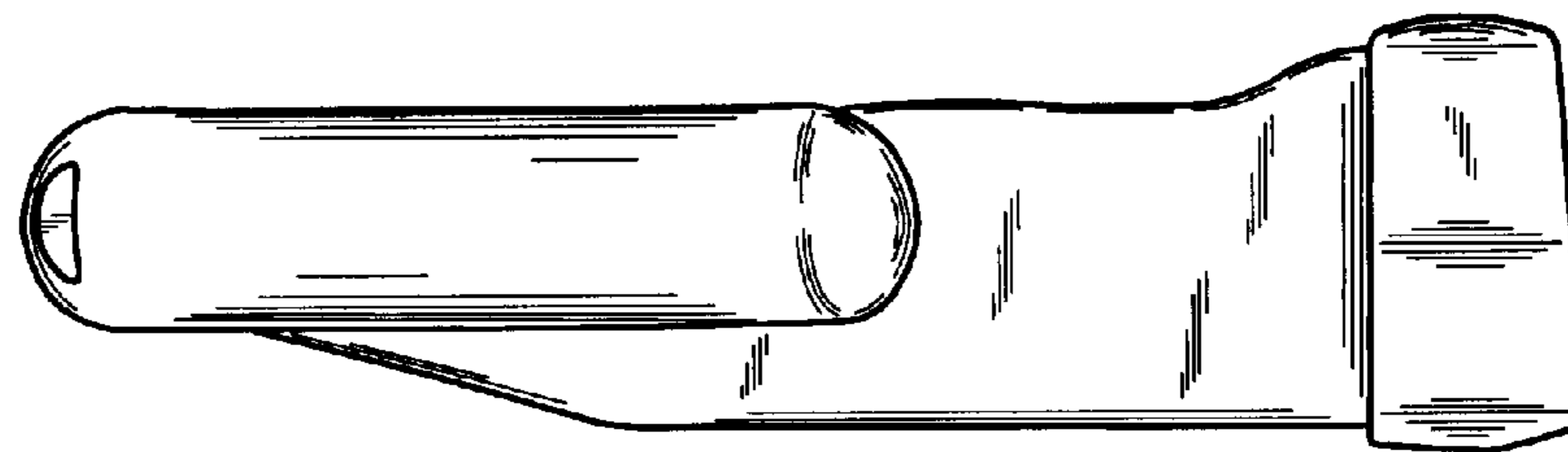

FIG. 3

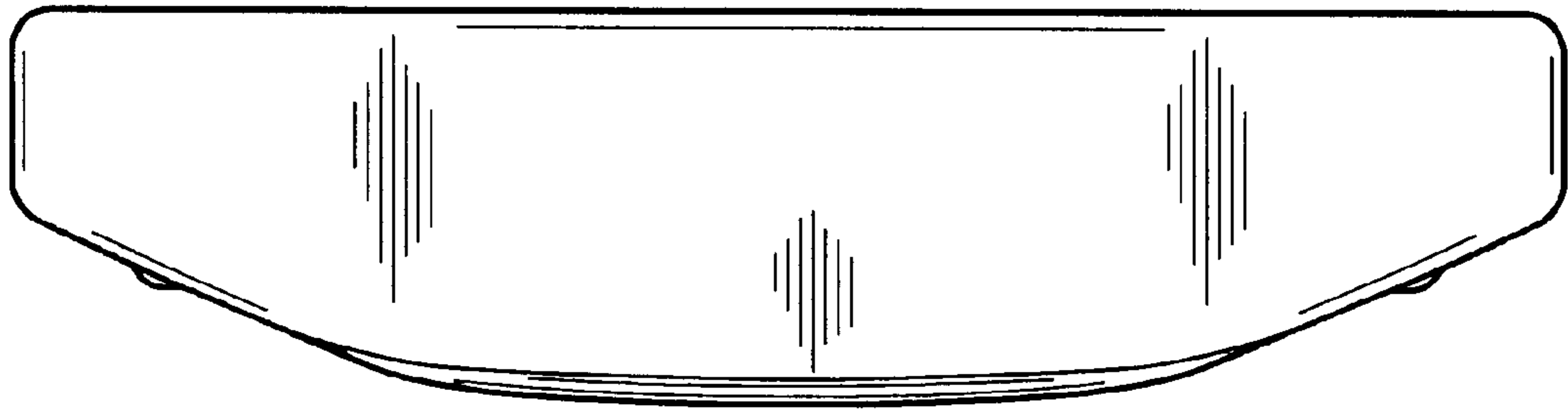

FIG. 4

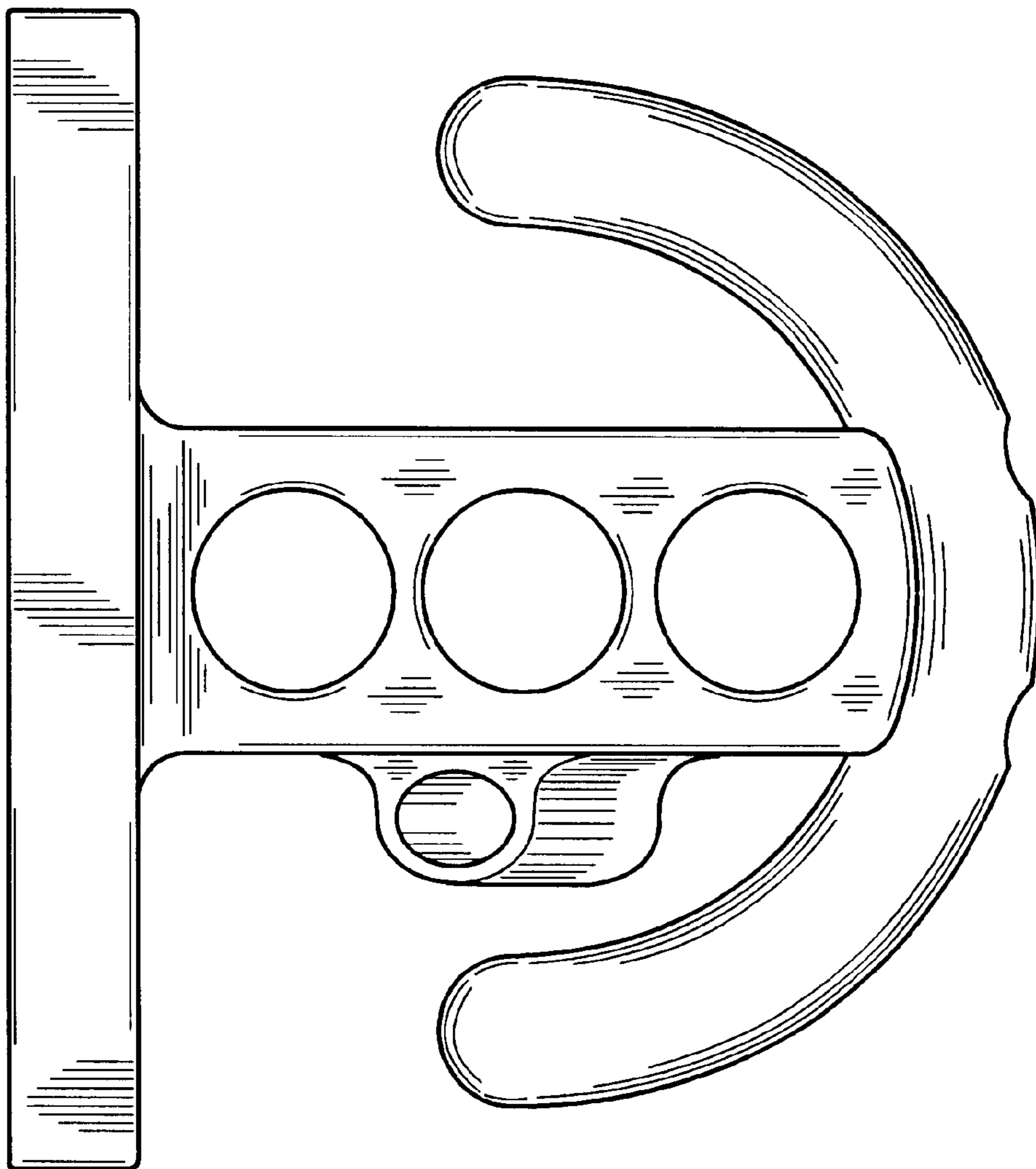

FIG. 5

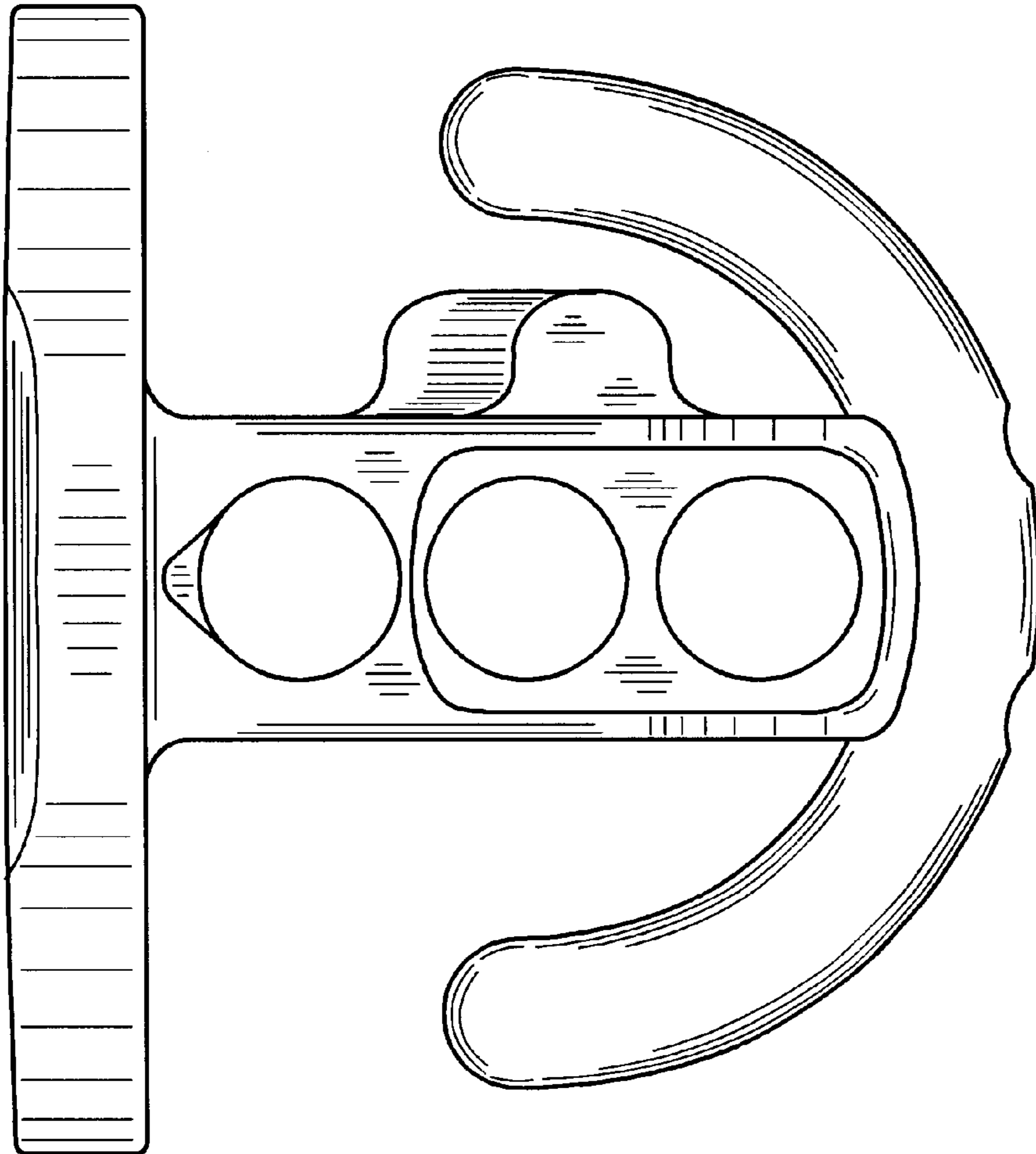

FIG. 6

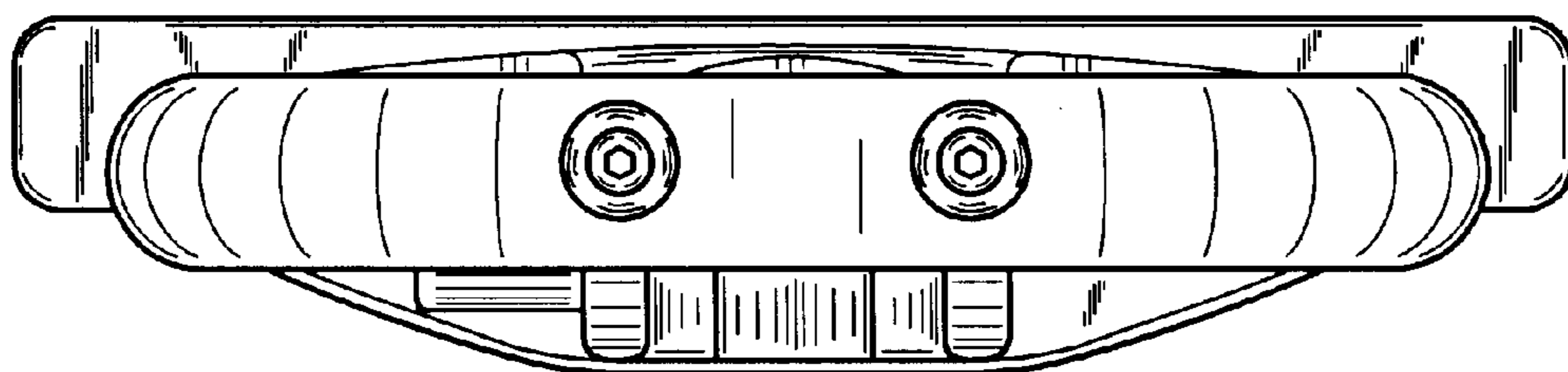

FIG. 7