



US00D477032S

(12) **United States Design Patent**
Fallon

(10) **Patent No.: US D477,032 S**

(45) **Date of Patent: ** Jul. 8, 2003**

(54) **NEON SIGN**

(75) **Inventor: Timothy Ross Fallon**, Boiling Springs, SC (US)

(73) **Assignee: Fallon Luminous Products**, Spartanburg, SC (US)

(**) **Term: 14 Years**

(21) **Appl. No.: 29/151,538**

(22) **Filed: Nov. 13, 2001**

Related U.S. Application Data

(62) Division of application No. 29/128,356, filed on Aug. 23, 2000, now Pat. No. Des. 456,850, which is a division of application No. 29/103,993, filed on Apr. 26, 1999, now Pat. No. Des. 433,453.

(51) **LOC (7) Cl. 19-08**

(52) **U.S. Cl. D20/10**

(58) **Field of Search** D20/10, 19, 21, D20/42; 362/811, 812; 40/130, 538, 540-553, 564, 572, 574, 584, 611, 612

(56) **References Cited**

U.S. PATENT DOCUMENTS

2,095,291 A	*	10/1937	Schneider	40/130
D161,715 S	*	1/1951	Siegel et al.	D20/10
D162,354 S	*	3/1951	Smith	D20/10
D433,453 S	*	11/2000	Fallon	D20/10
D460,490 S	*	7/2002	Fallon	D20/10

* cited by examiner

Primary Examiner—Marcus A. Jackson

(74) *Attorney, Agent, or Firm*—Joseph T. Guy; Nexsen Pruet Jacobs & Pollard, LLC

(57) **CLAIM**

The ornamental design for a neon sign, as shown and described.

DESCRIPTION

FIG. 1 is a perspective view of an embodiment of a neon sign showing our new design;

FIG. 2 is a front elevation view thereof;

FIG. 3 is a rear elevation view thereof;

FIG. 4 is a top plan view thereof;

FIG. 5 is a bottom plan view thereof;

FIG. 6 is a side elevation view thereof;

FIG. 7 is the opposite side elevation thereof;

FIG. 8 is a perspective view of an embodiment of a neon sign showing our new design;

FIG. 9 is a front elevation view thereof;

FIG. 10 is a rear elevation view thereof;

FIG. 11 is a top plan view thereof;

FIG. 12 is a bottom plan view thereof;

FIG. 13 is a side elevation view thereof;

FIG. 14 is the opposite side elevation thereof;

FIG. 15 is a perspective view of an embodiment of a neon sign showing our new design;

FIG. 16 is a front elevation view thereof;

FIG. 17 is a rear elevation view thereof;

FIG. 18 is a top plan view thereof;

FIG. 19 is a bottom plan view thereof;

FIG. 20 is a side elevation view thereof;

FIG. 21 is the opposite side elevation thereof;

FIG. 22 is a perspective view of an embodiment of a neon sign showing our new design;

FIG. 23 is a front elevation view thereof;

FIG. 24 is a rear elevation view thereof;

FIG. 25 is a top plan view thereof;

FIG. 26 is a bottom plan view thereof;

FIG. 27 is a side elevation view thereof;

FIG. 28 is the opposite side elevation thereof;

FIG. 29 is a perspective view of an embodiment of a neon sign showing our new design;

FIG. 30 is a front elevation view thereof;

FIG. 31 is a rear elevation view thereof;

FIG. 32 is a top plan view thereof;

FIG. 33 is a bottom plan view thereof;

FIG. 34 is a side elevation thereof;

FIG. 35 is the opposite side elevation thereof;

FIG. 36 is a front elevation view of an embodiment of a neon sign showing our new design;

FIG. 37 is a rear elevation view thereof;

FIG. 38 is a top plan view thereof;

FIG. 39 is a bottom plan view thereof;

FIG. 40 is a side elevation view thereof; and,

FIG. 41 is the opposite side elevation thereof.

1 Claim, 14 Drawing Sheets

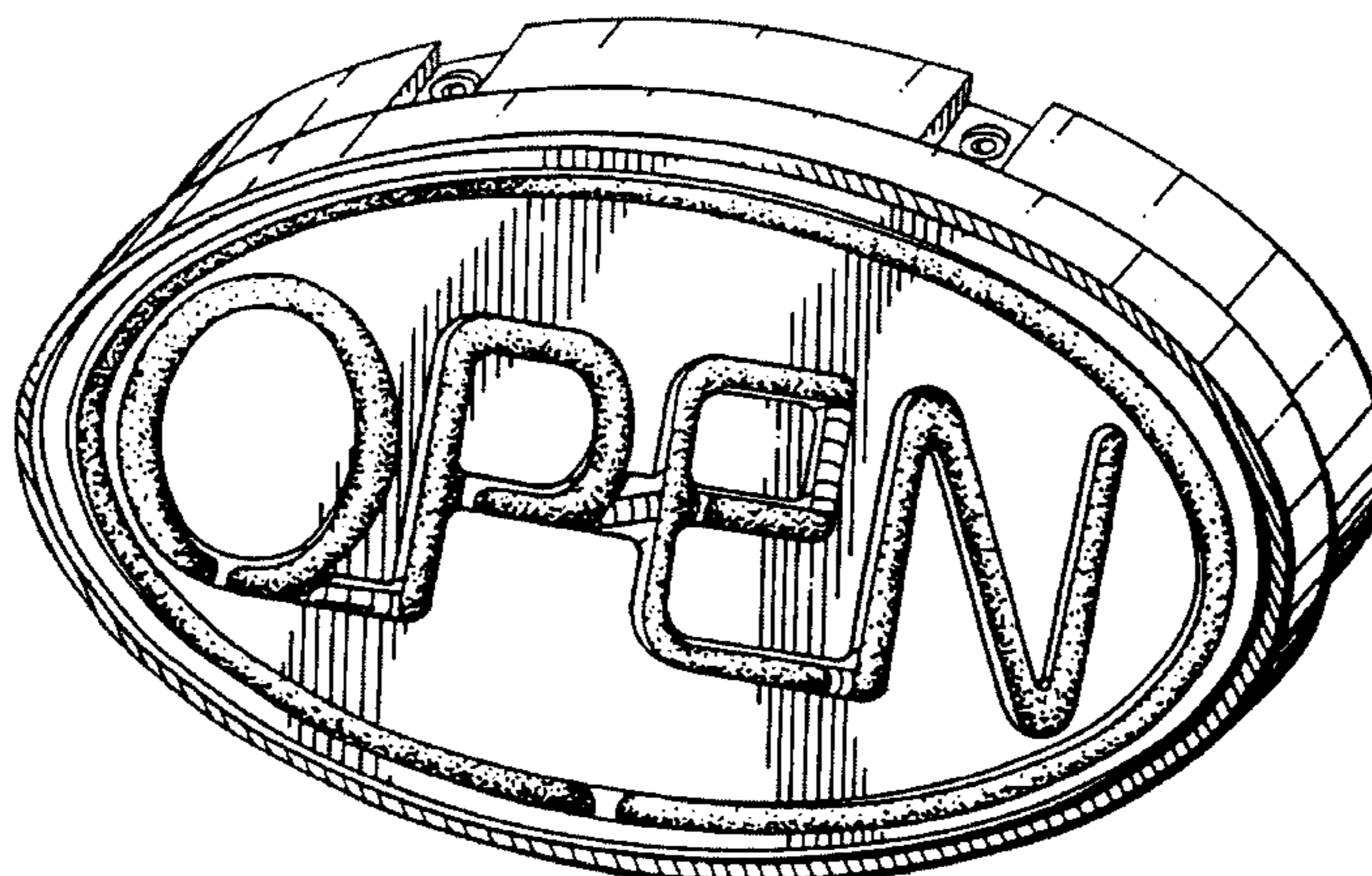

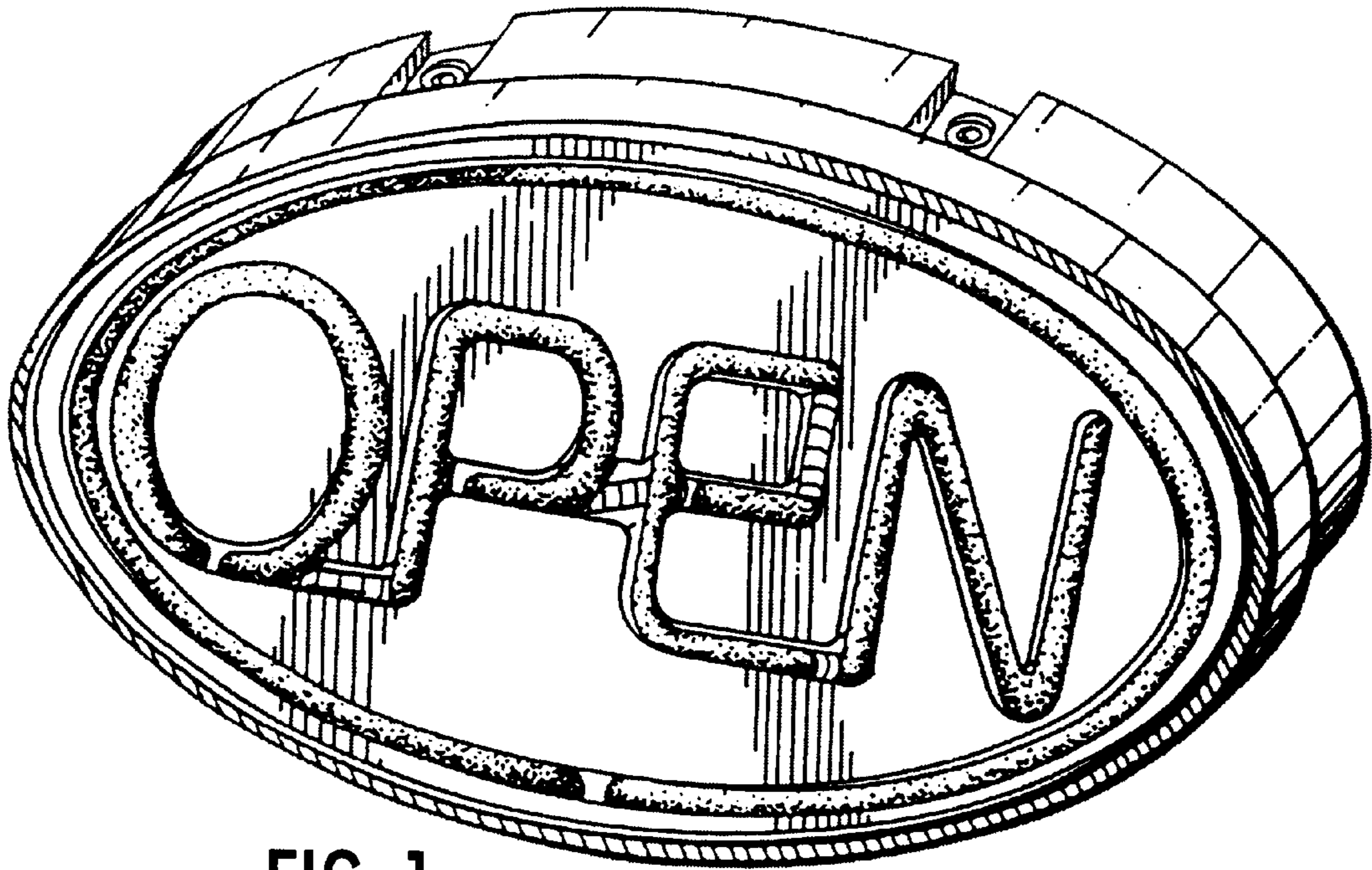

FIG. 1

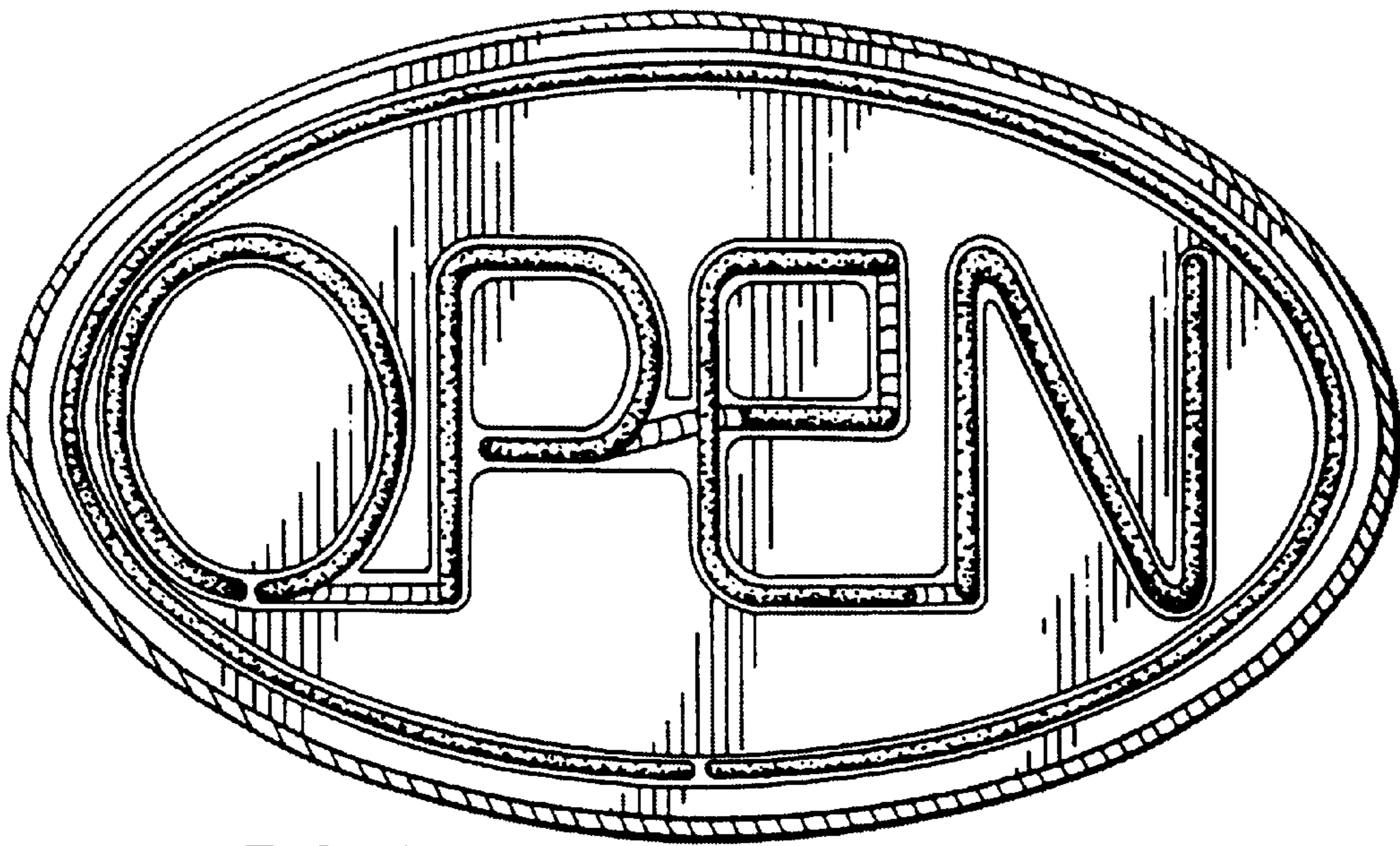

FIG. 2

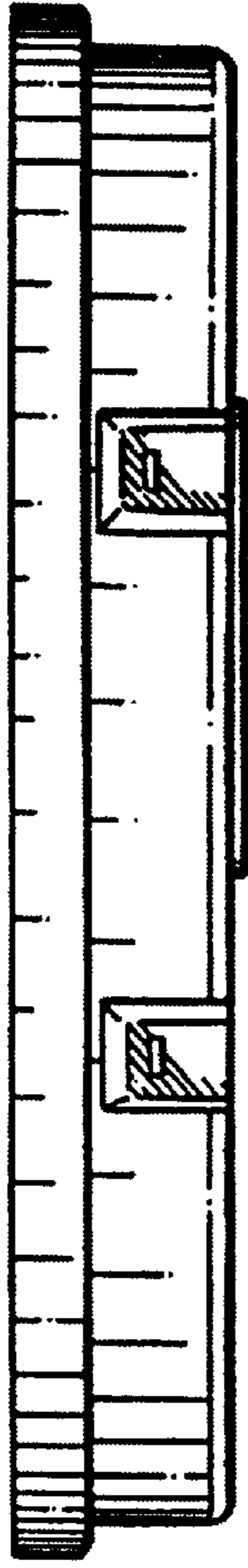

FIG. 4

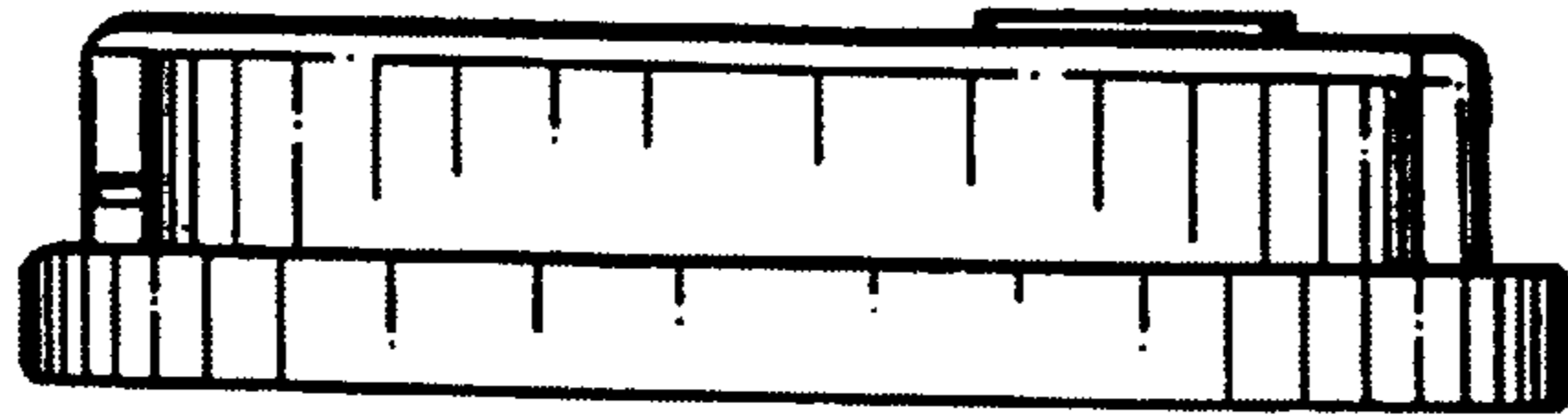

FIG. 6

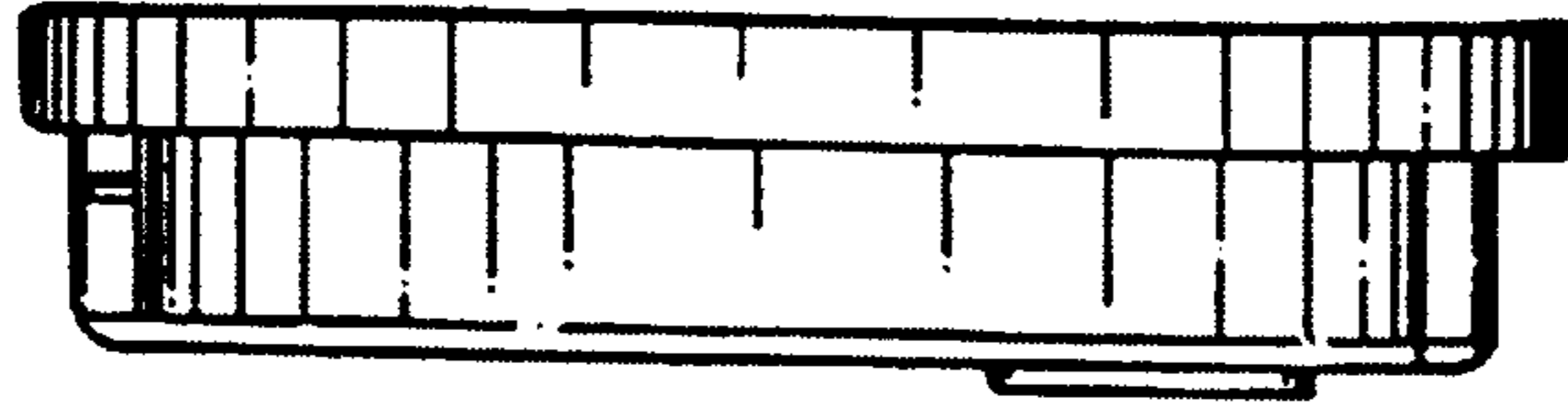

FIG. 7

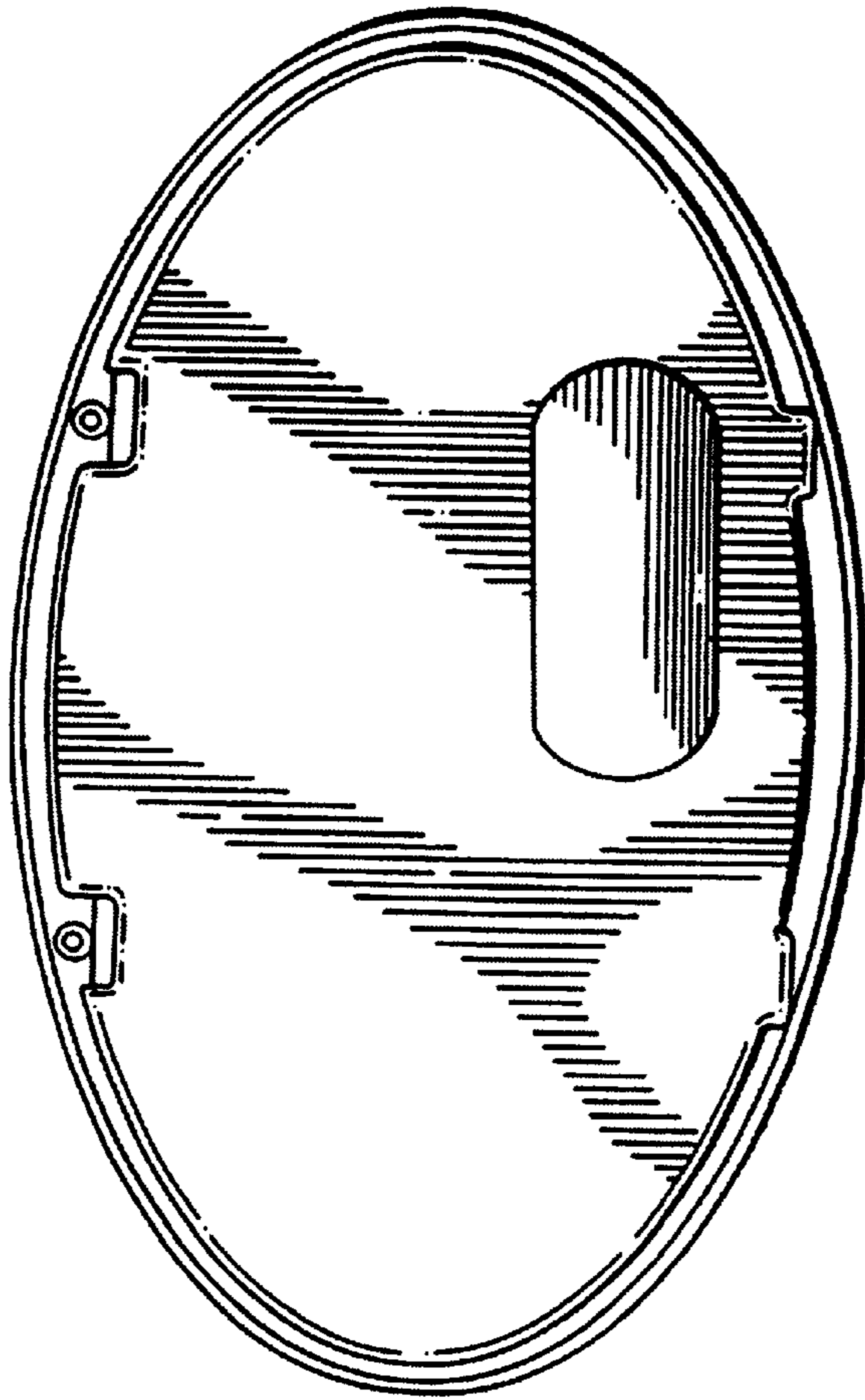

FIG. 3

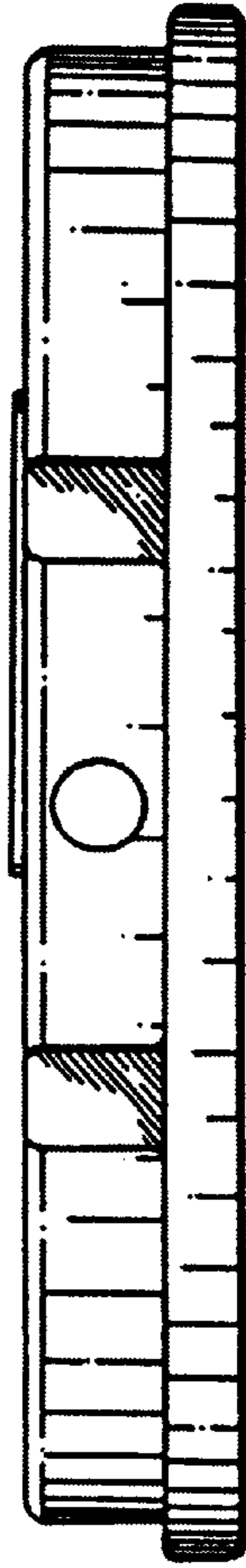

FIG. 5

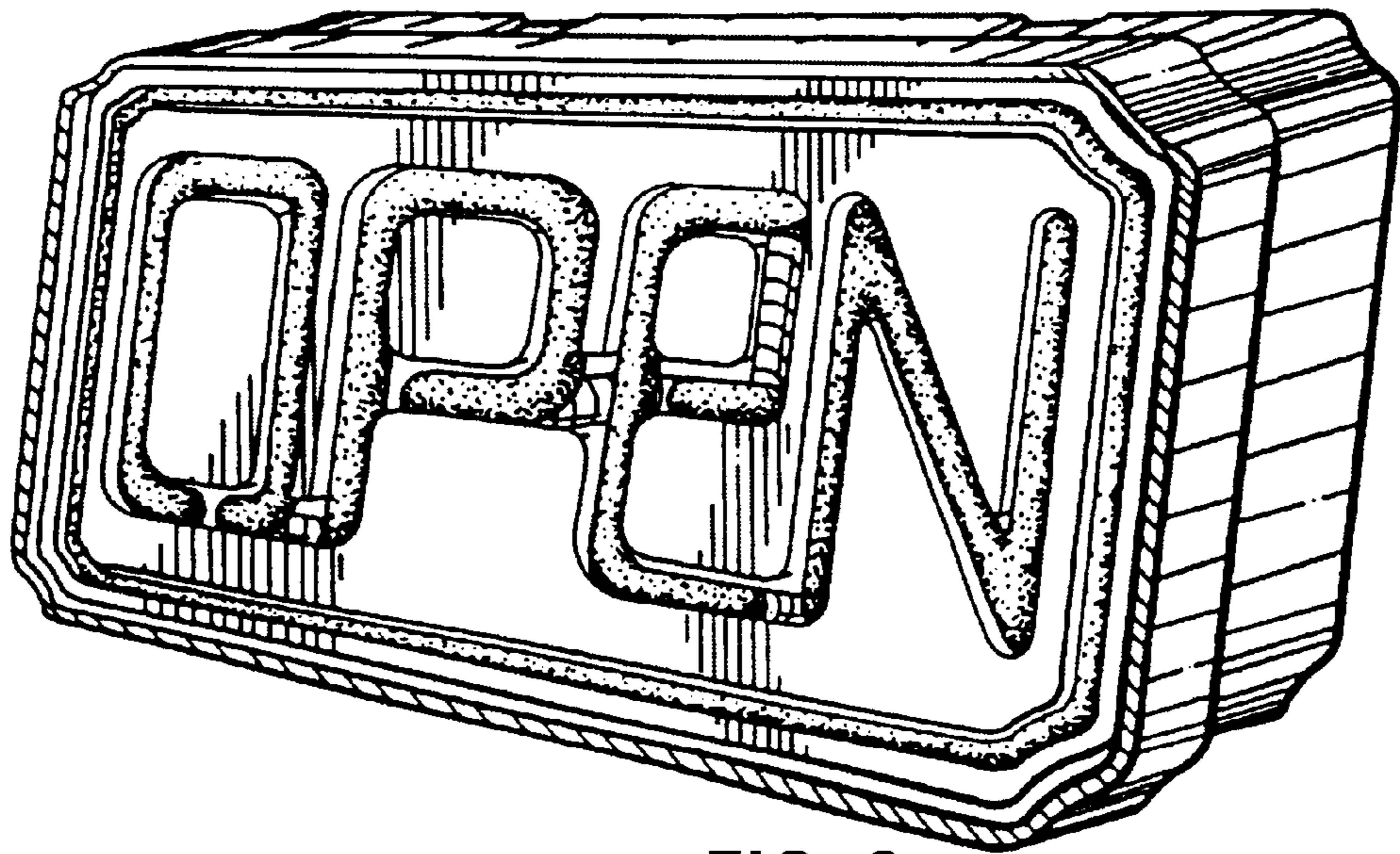

FIG. 8

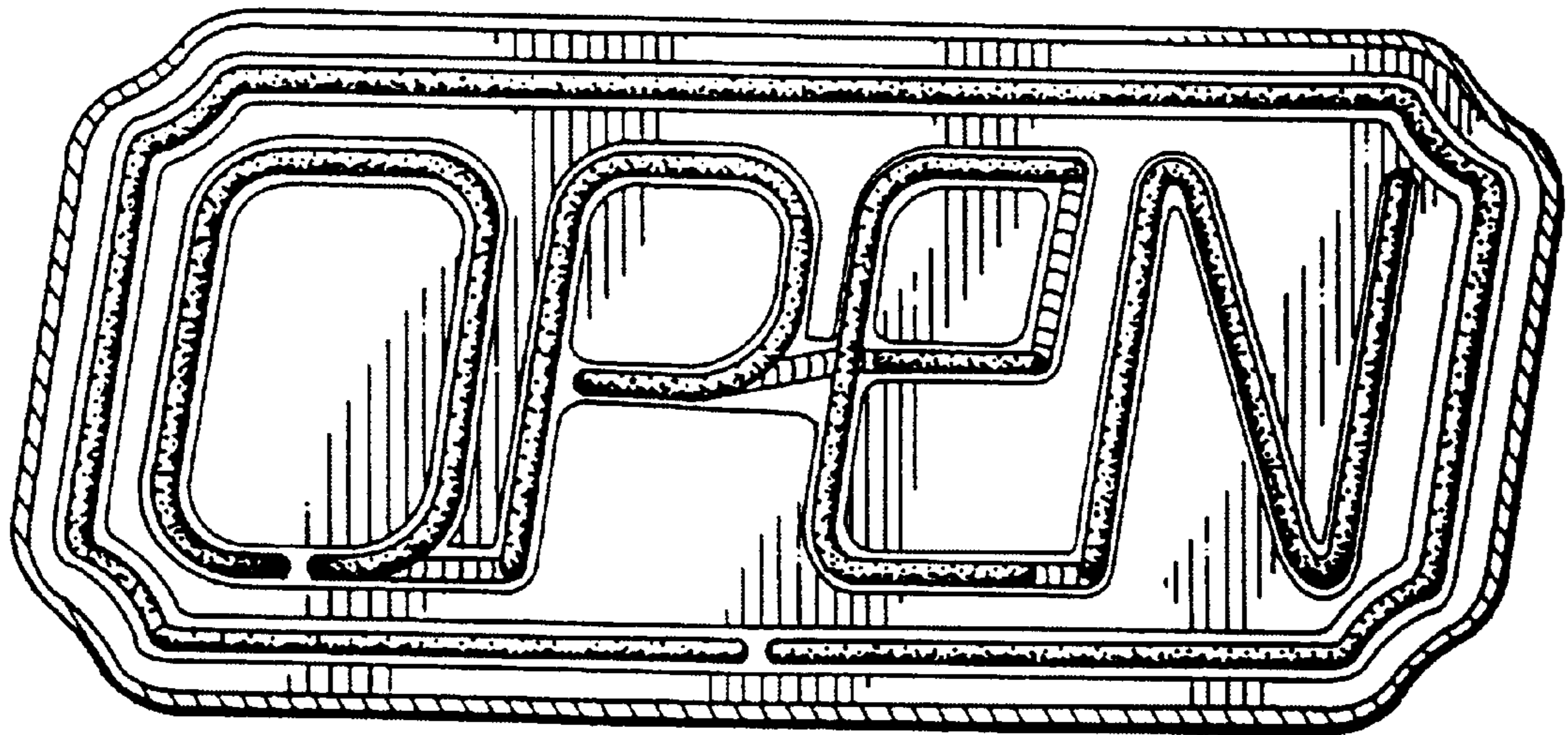

FIG. 9

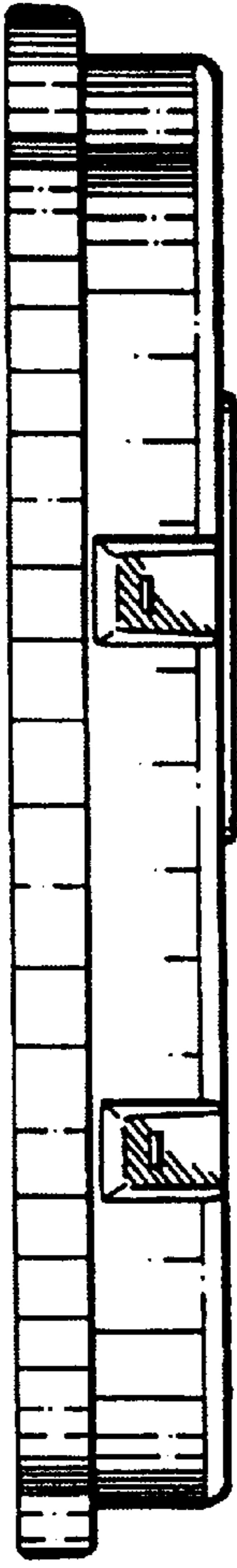

FIG. 11

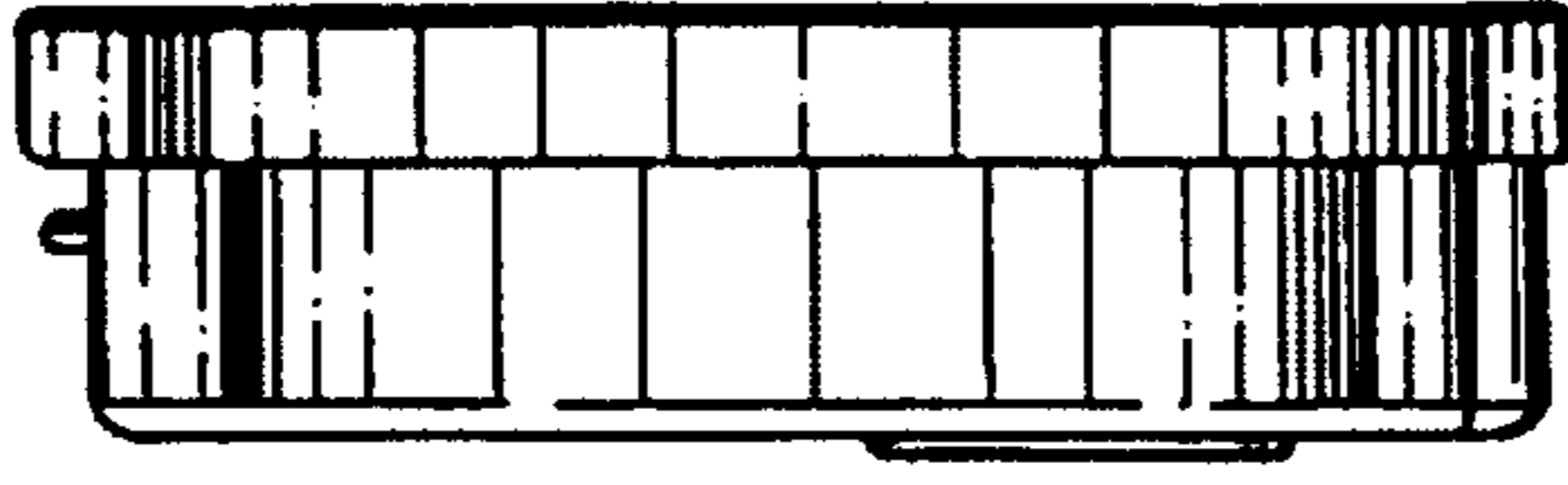

FIG. 14

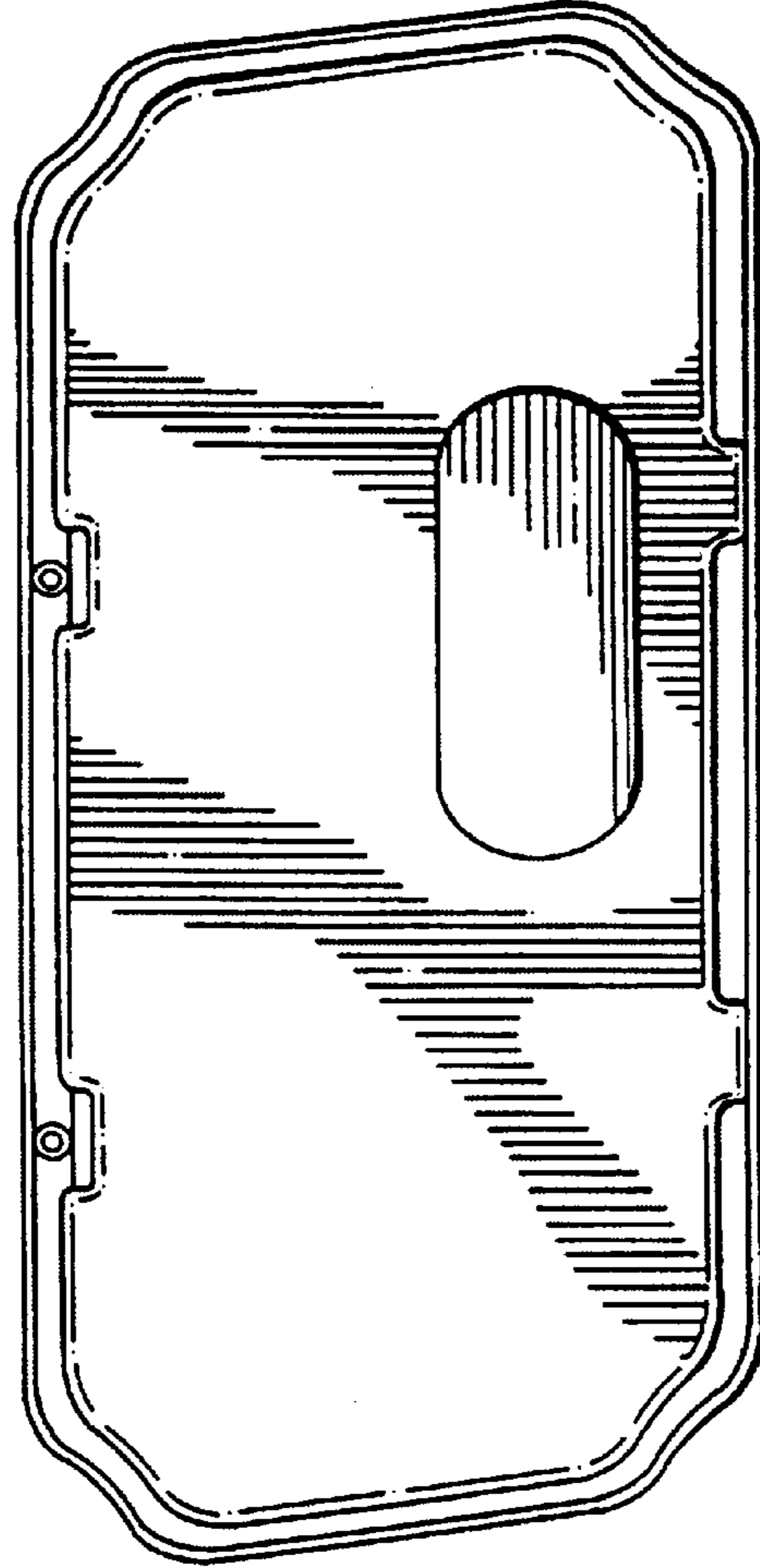

FIG. 10

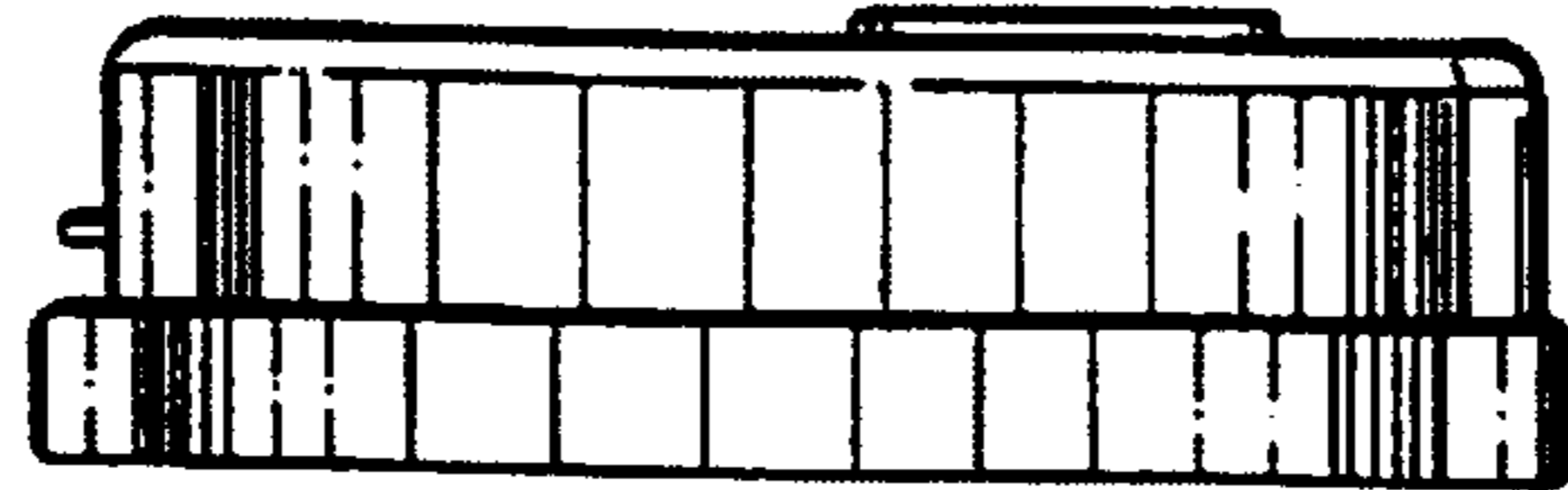

FIG. 13

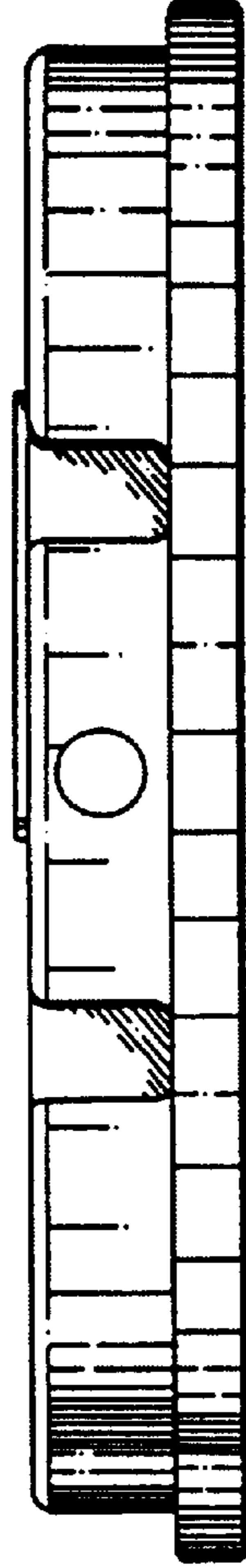

FIG. 12

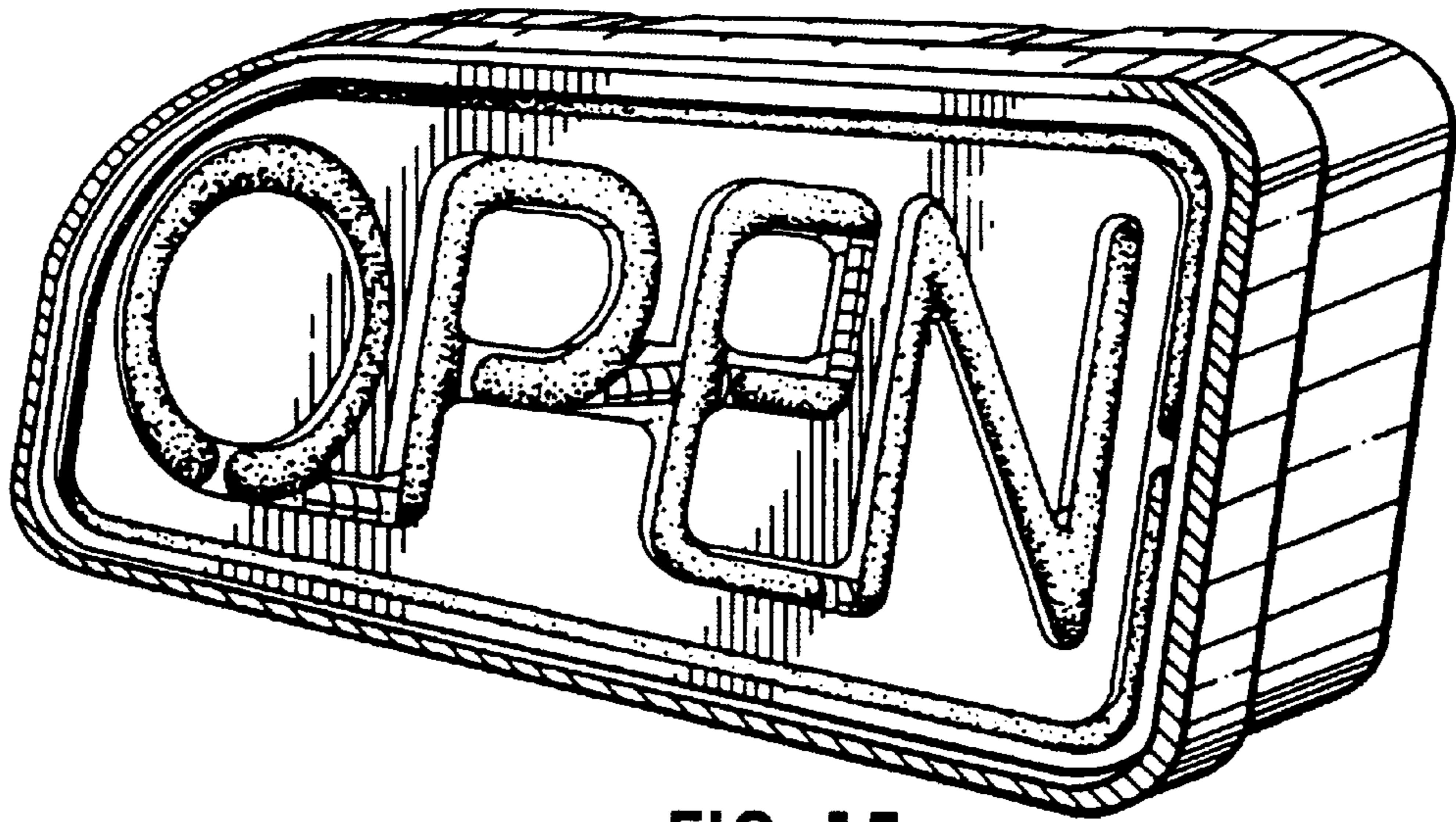

FIG. 15

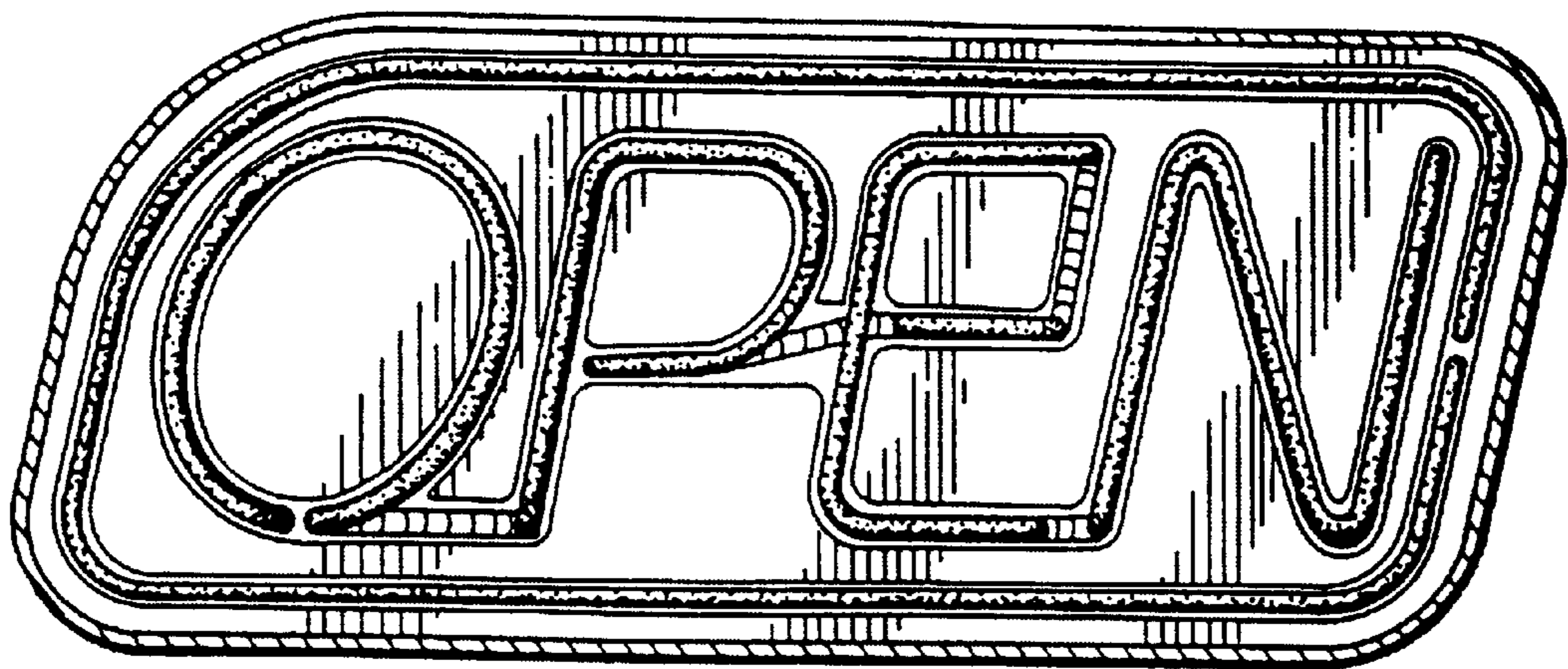

FIG. 16

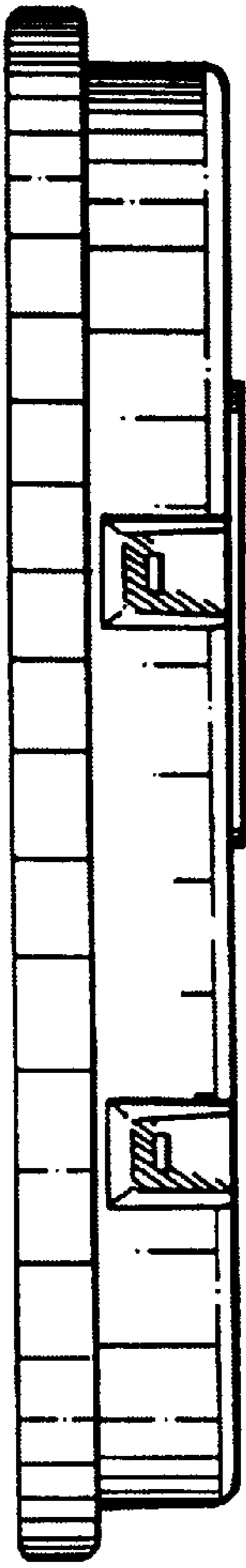

FIG. 18

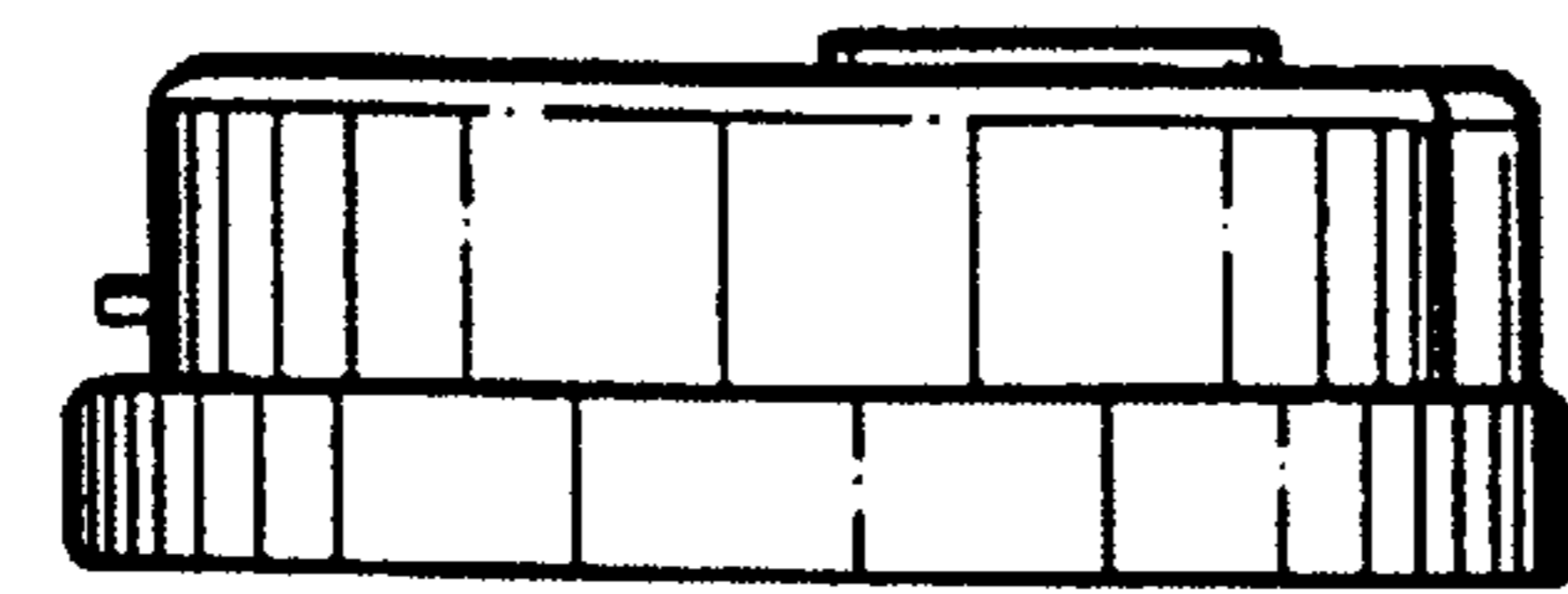

FIG. 20

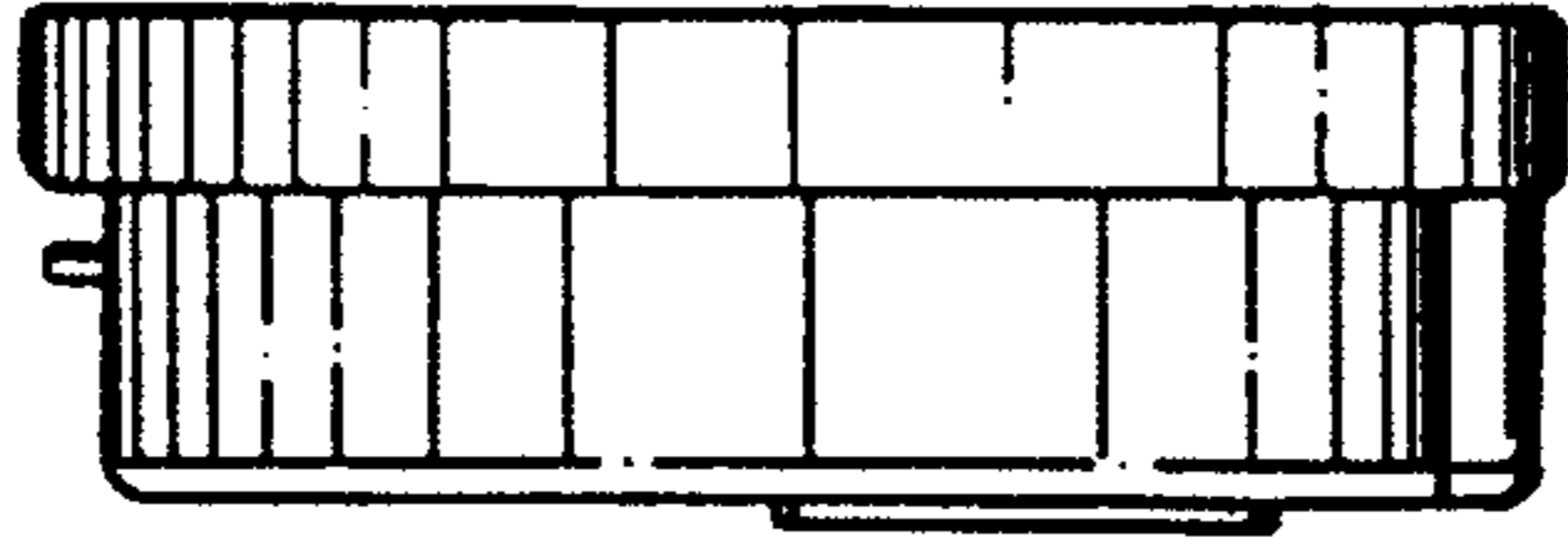

FIG. 21

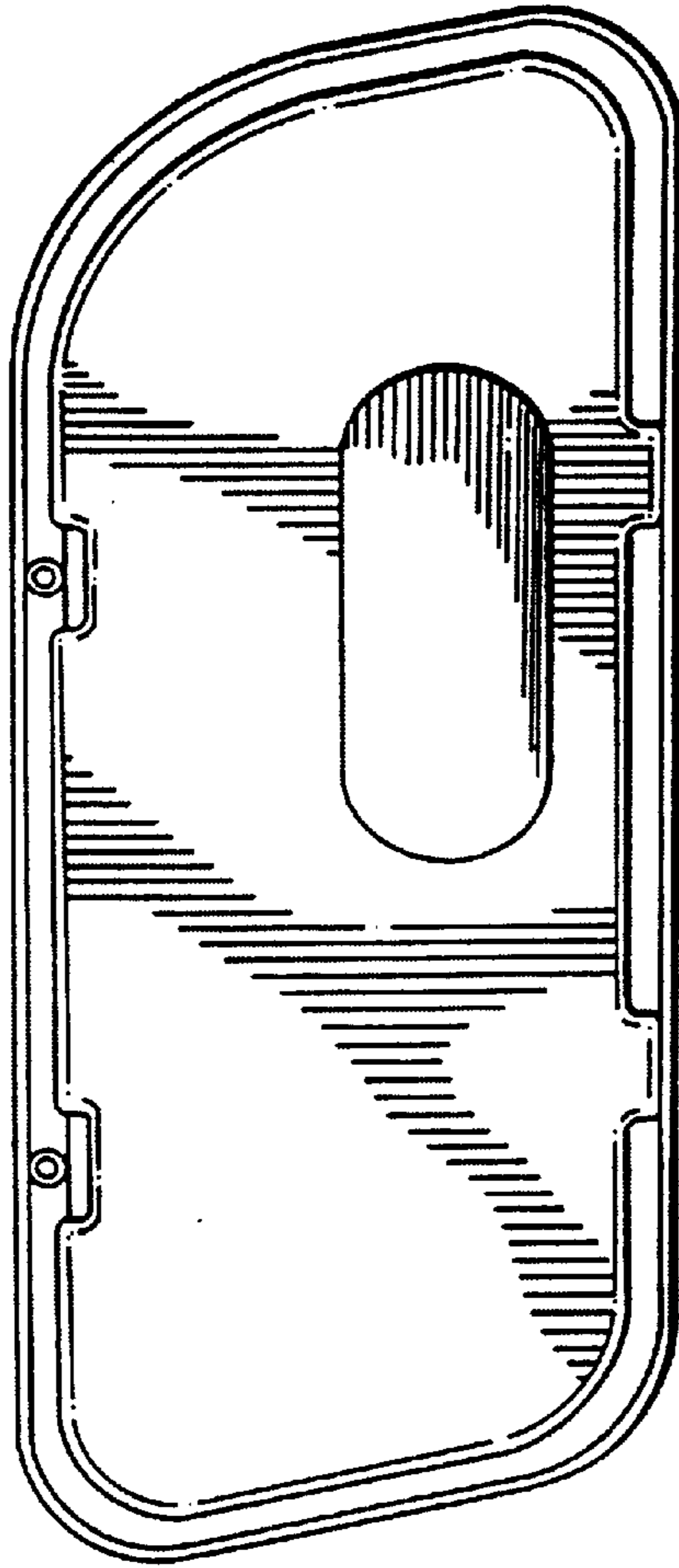

FIG. 17

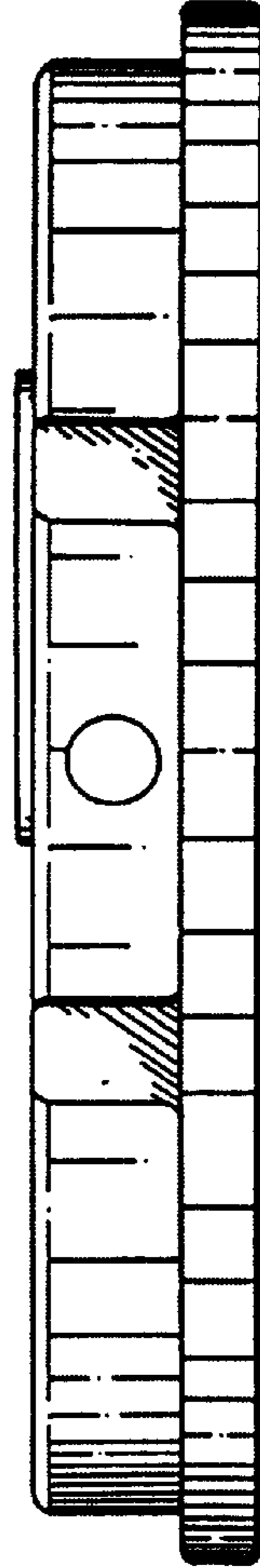

FIG. 19

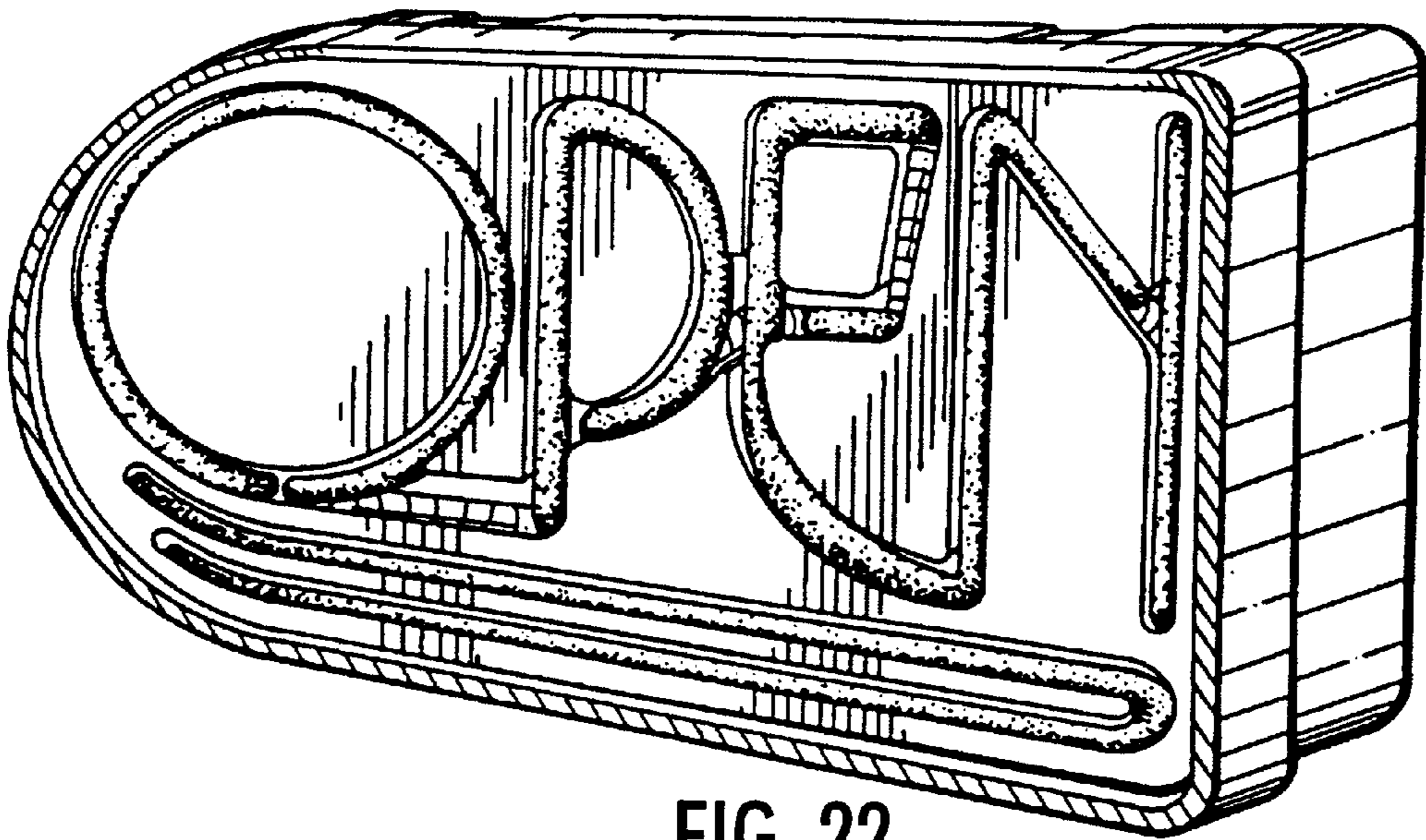

FIG. 22

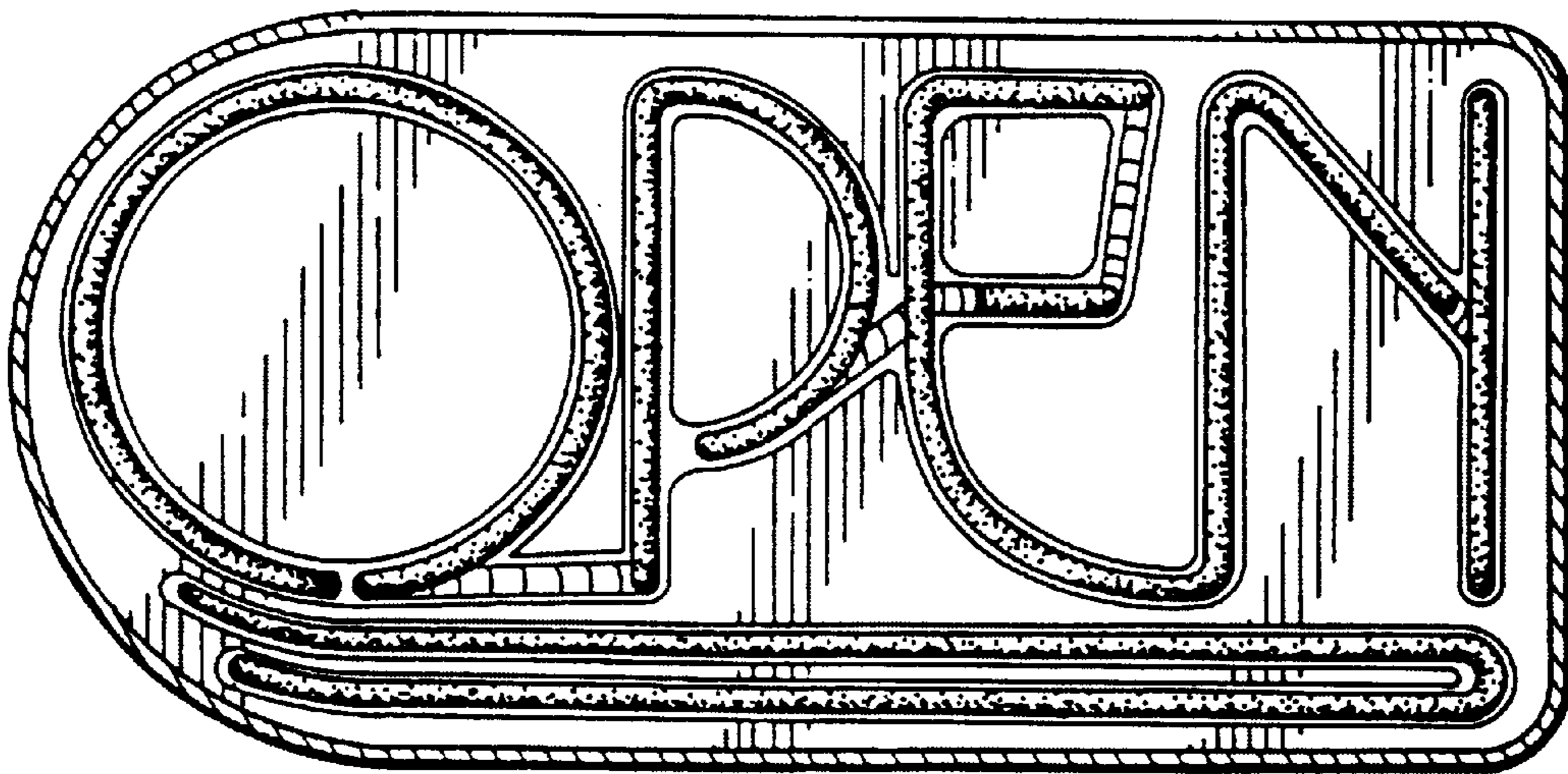

FIG. 23

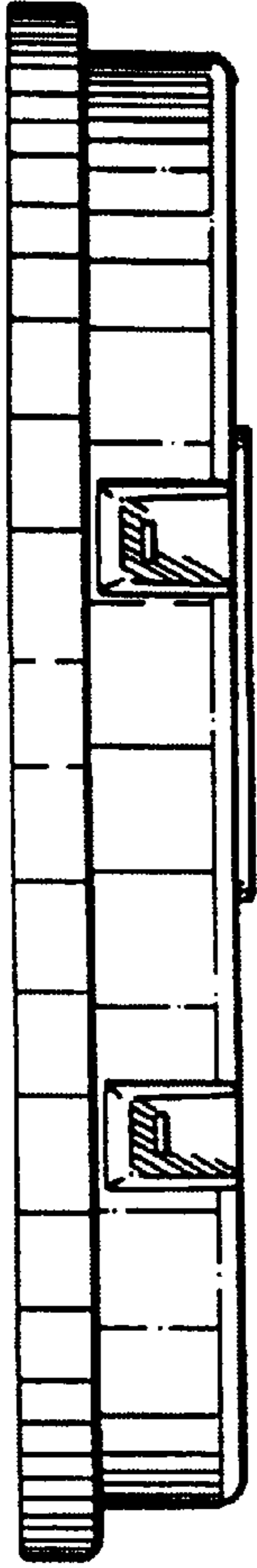

FIG. 25

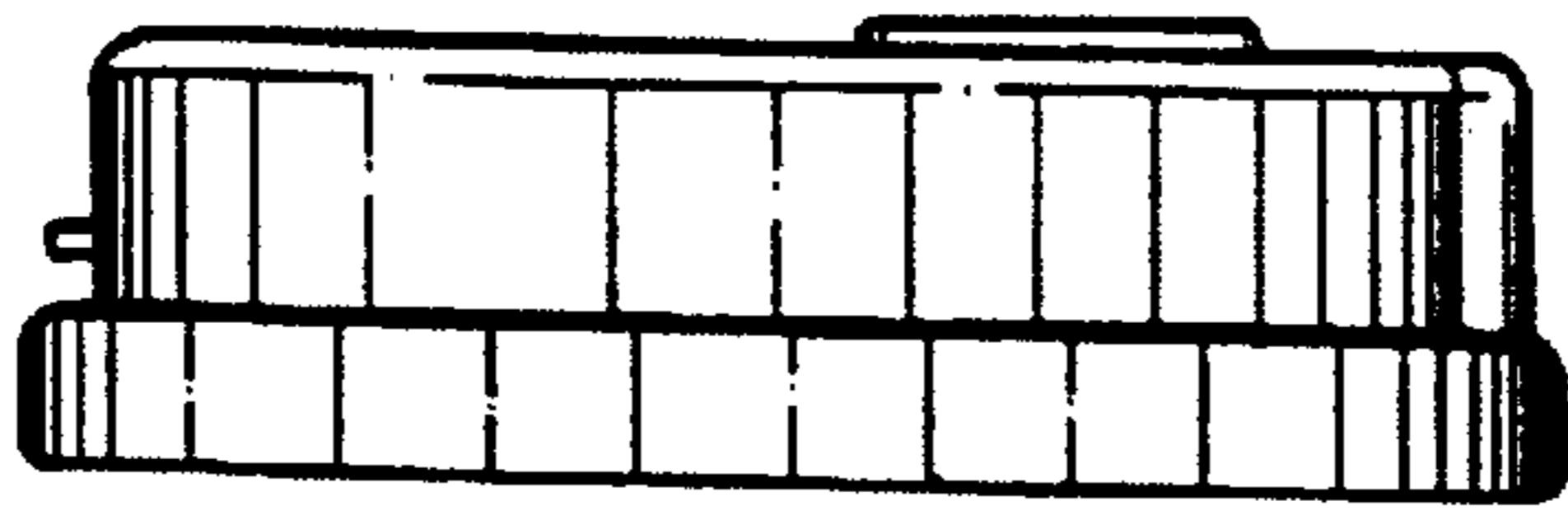

FIG. 27

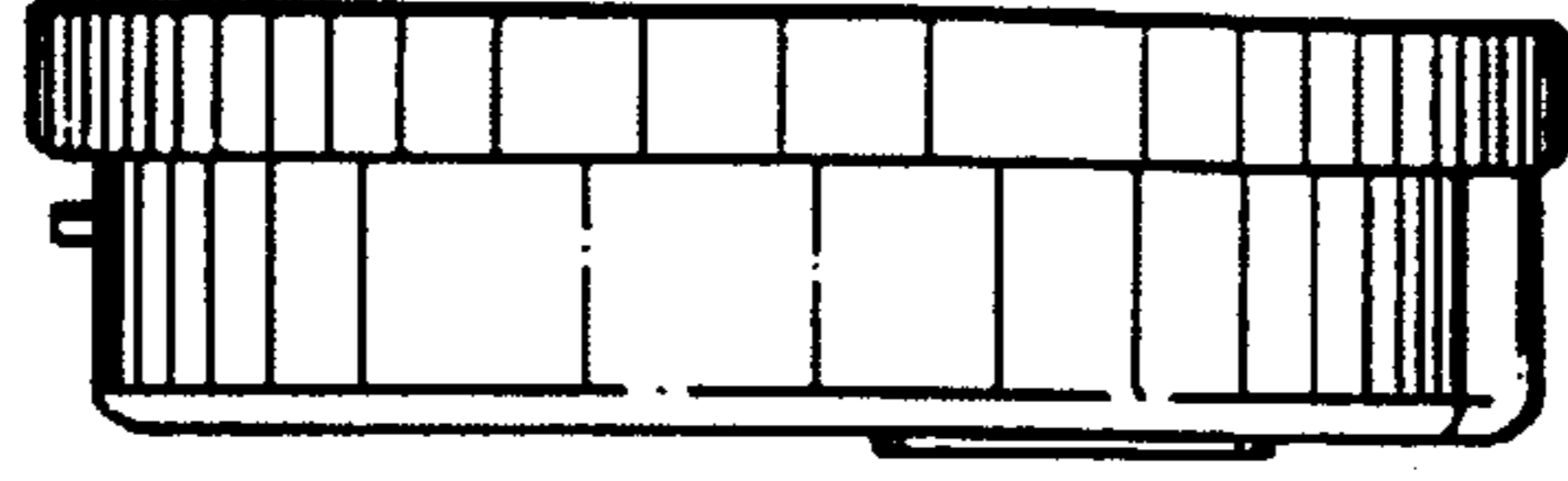

FIG. 28

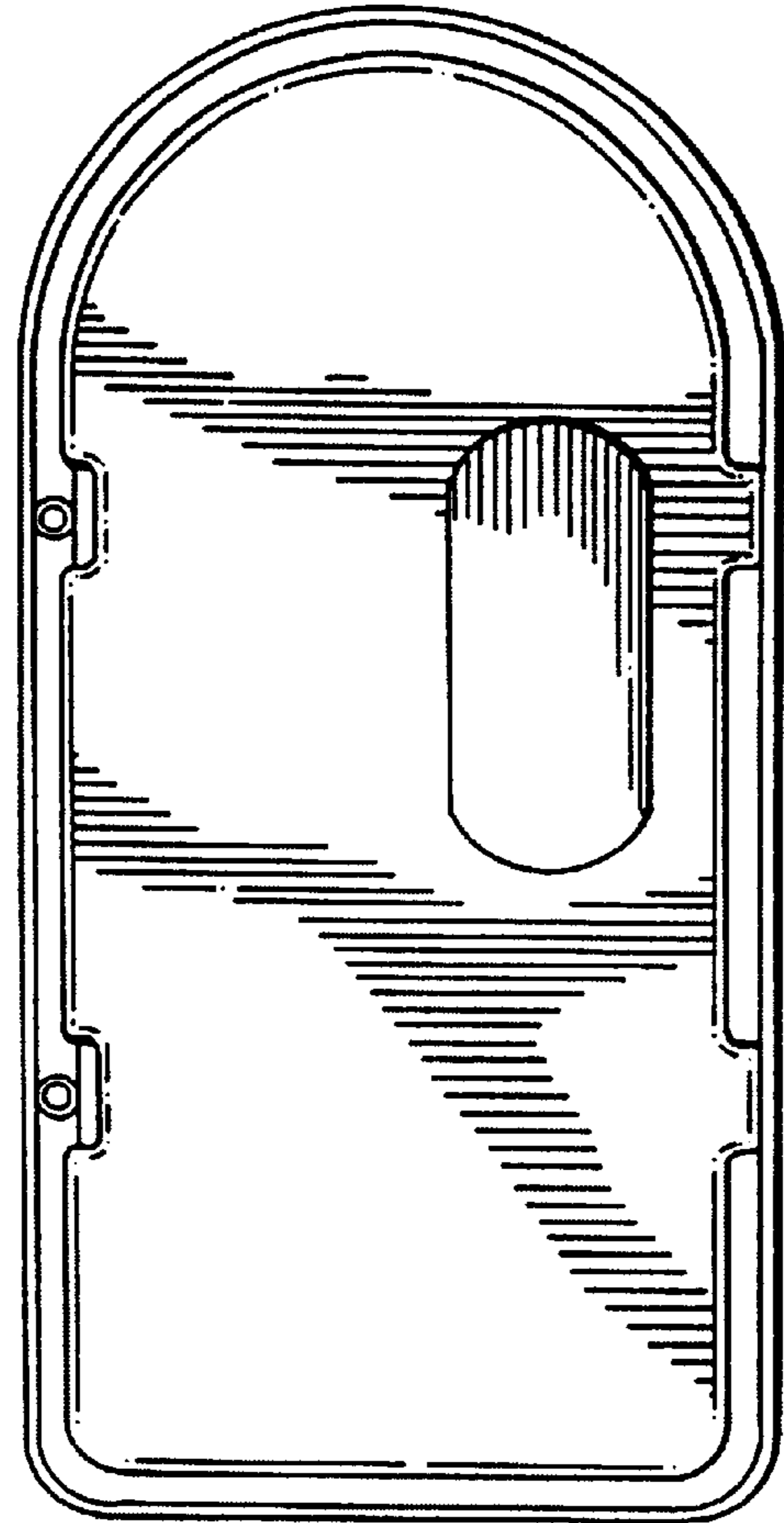

FIG. 24

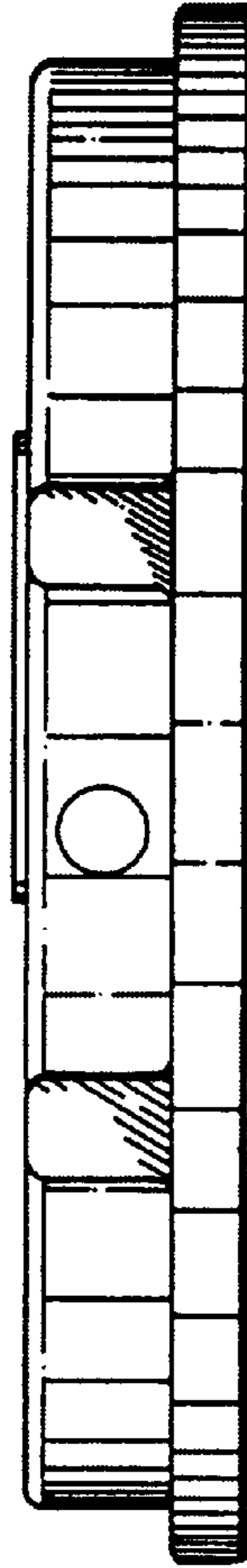

FIG. 26

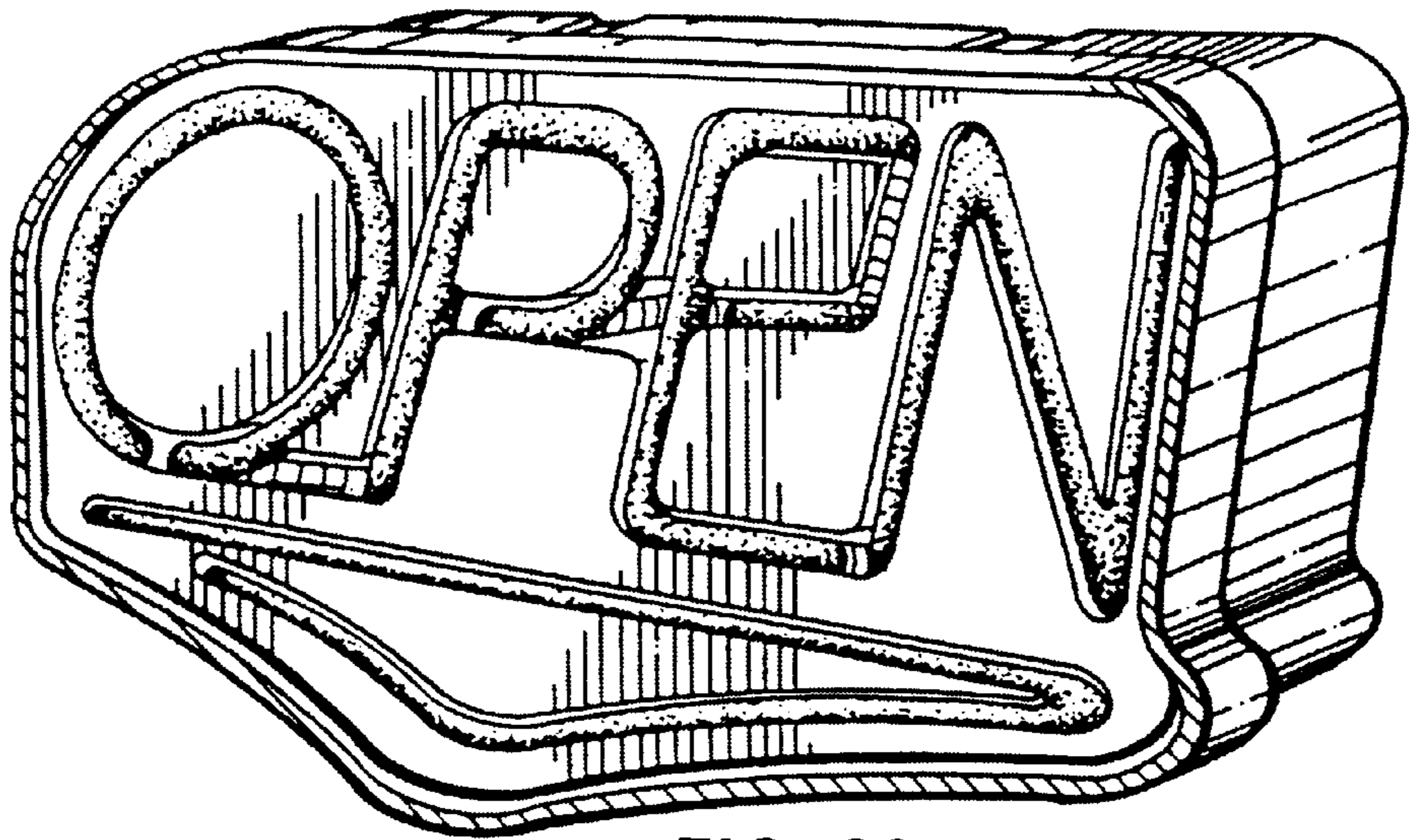

FIG. 29

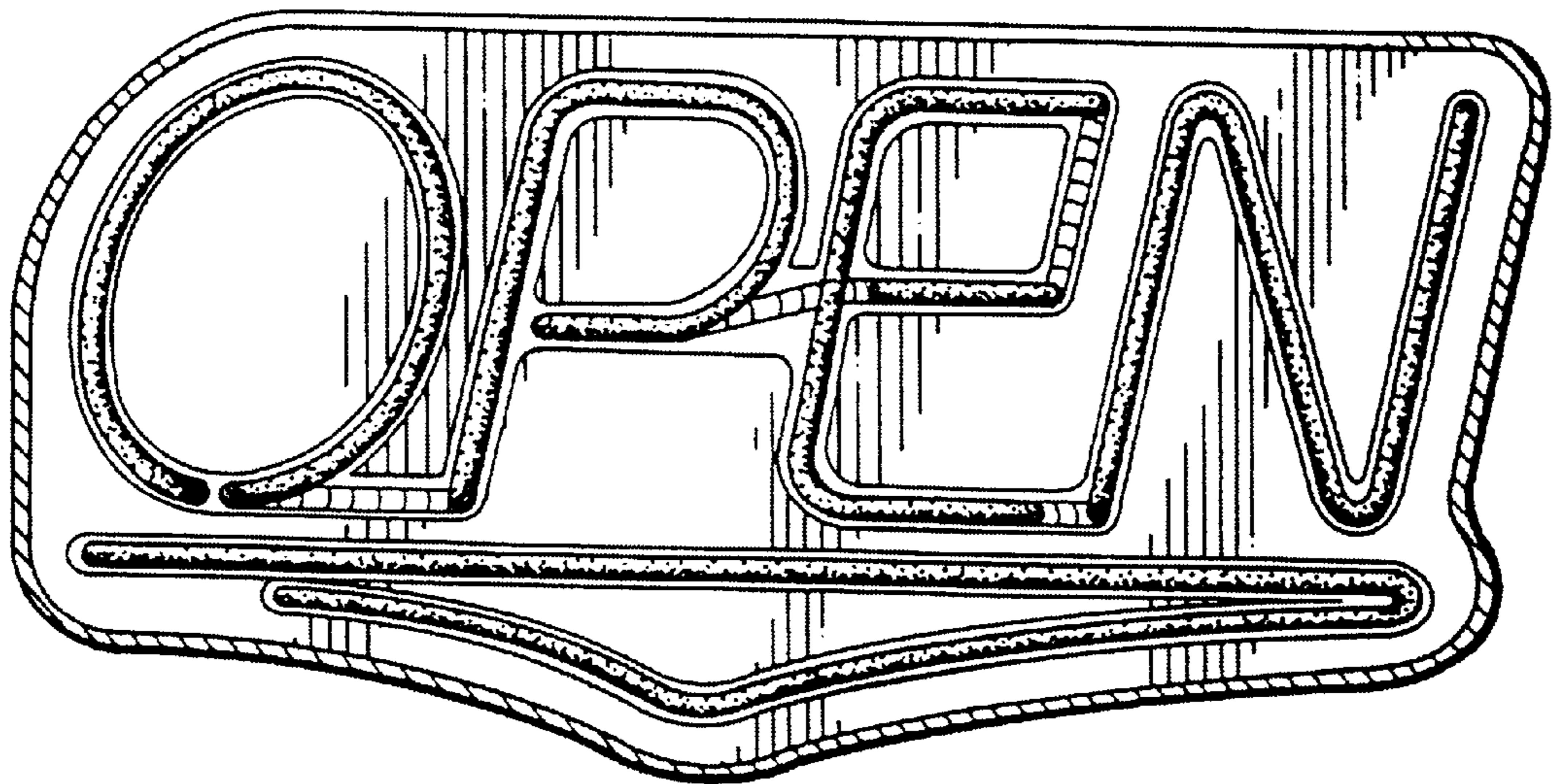

FIG. 30

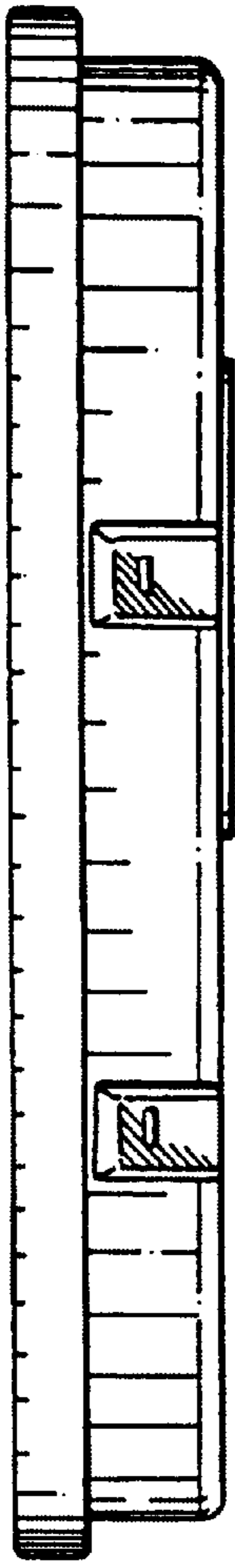

FIG. 32

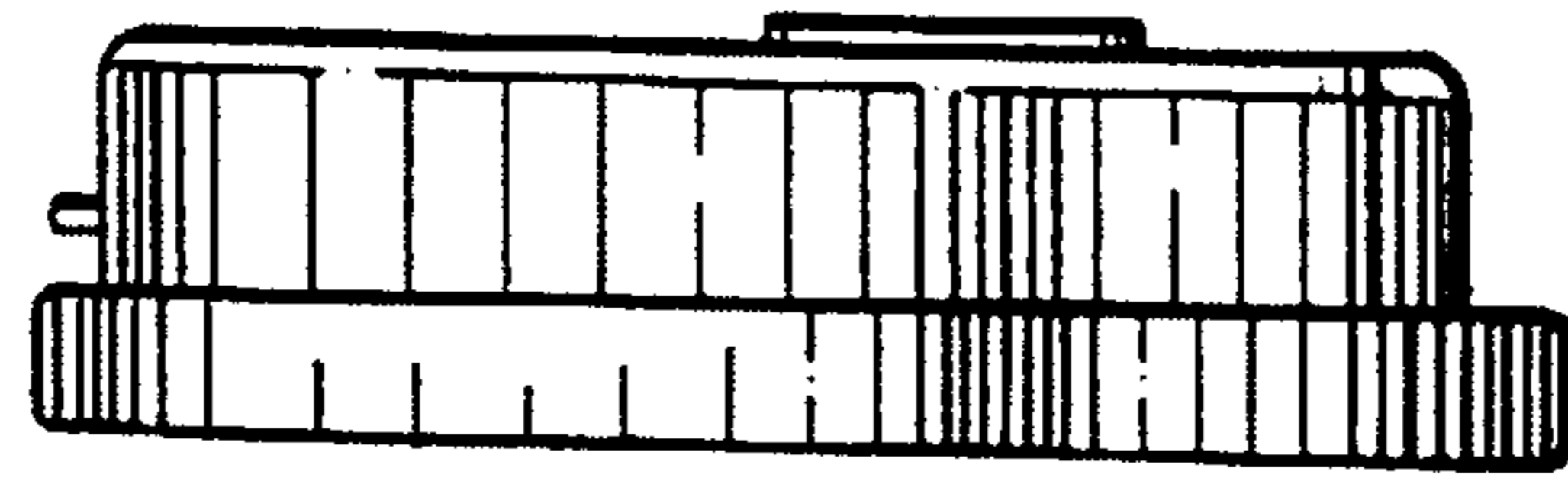

FIG. 34

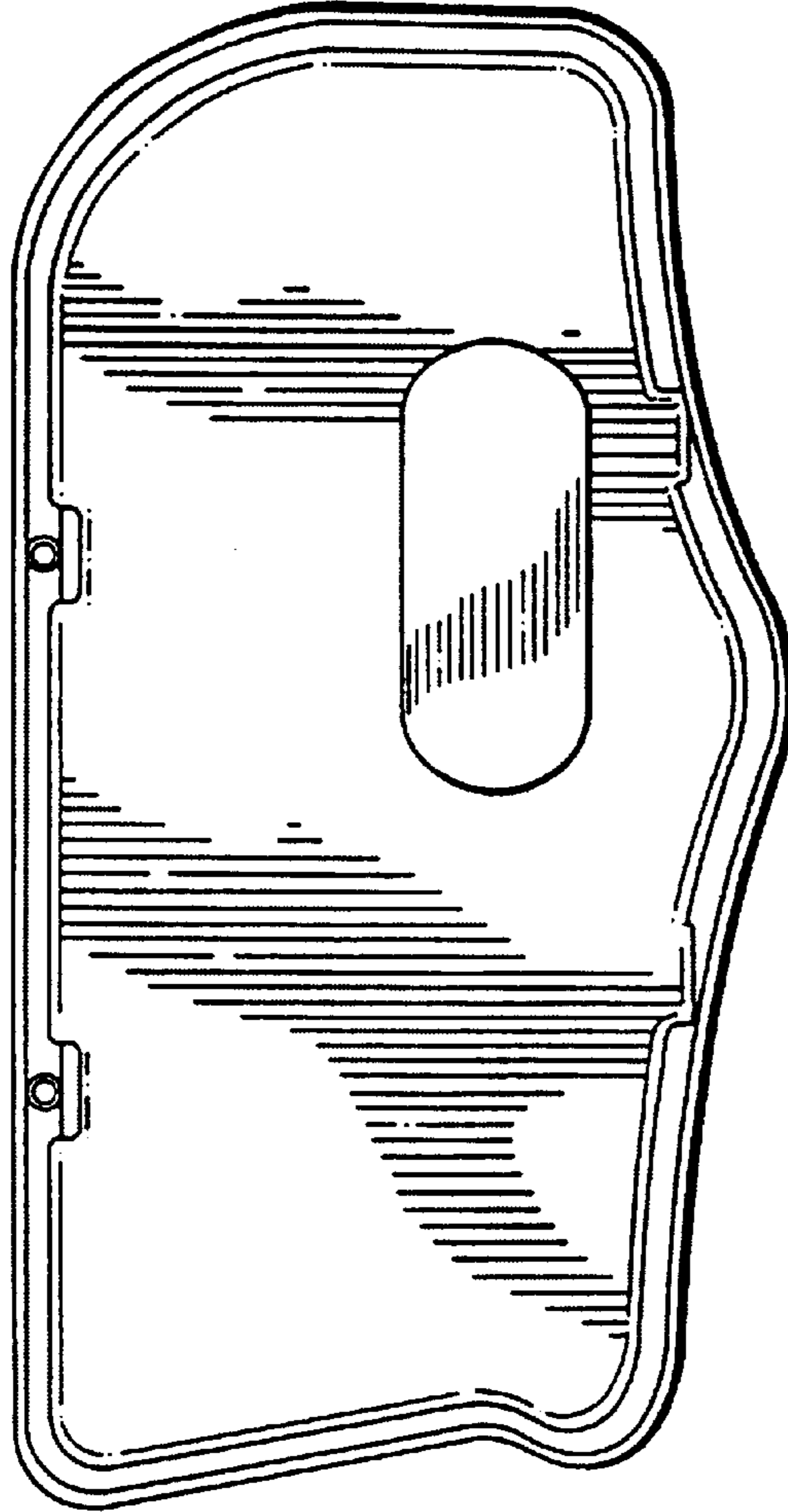

FIG. 31

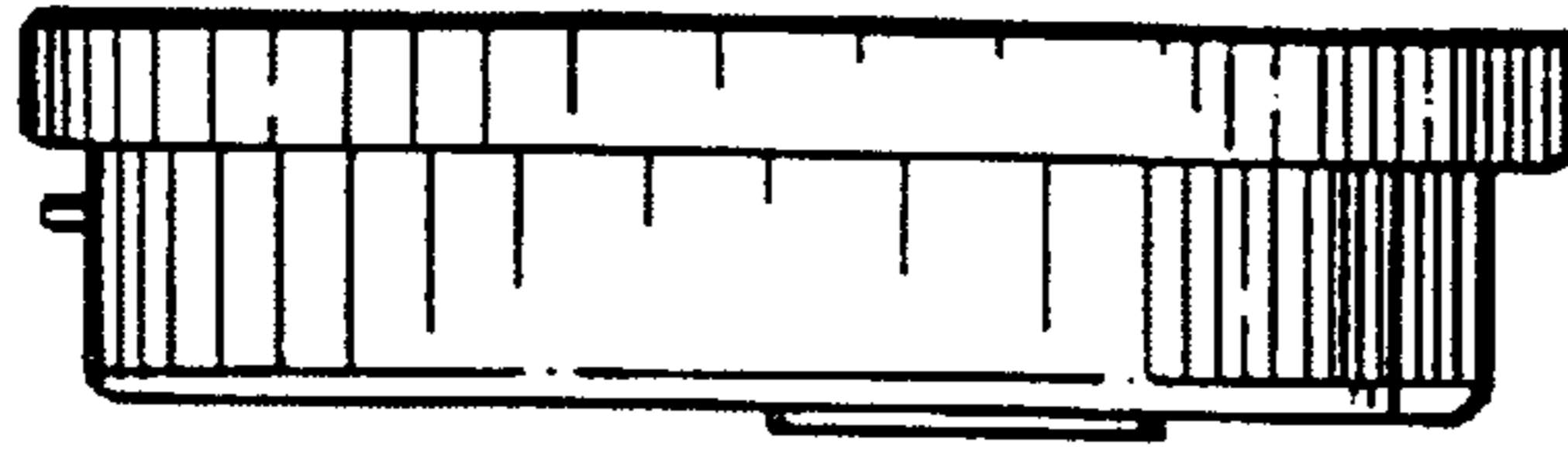

FIG. 35

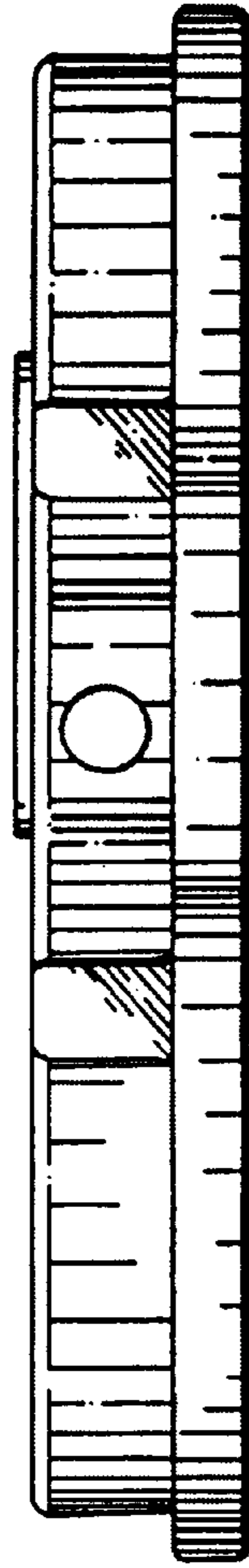

FIG. 33

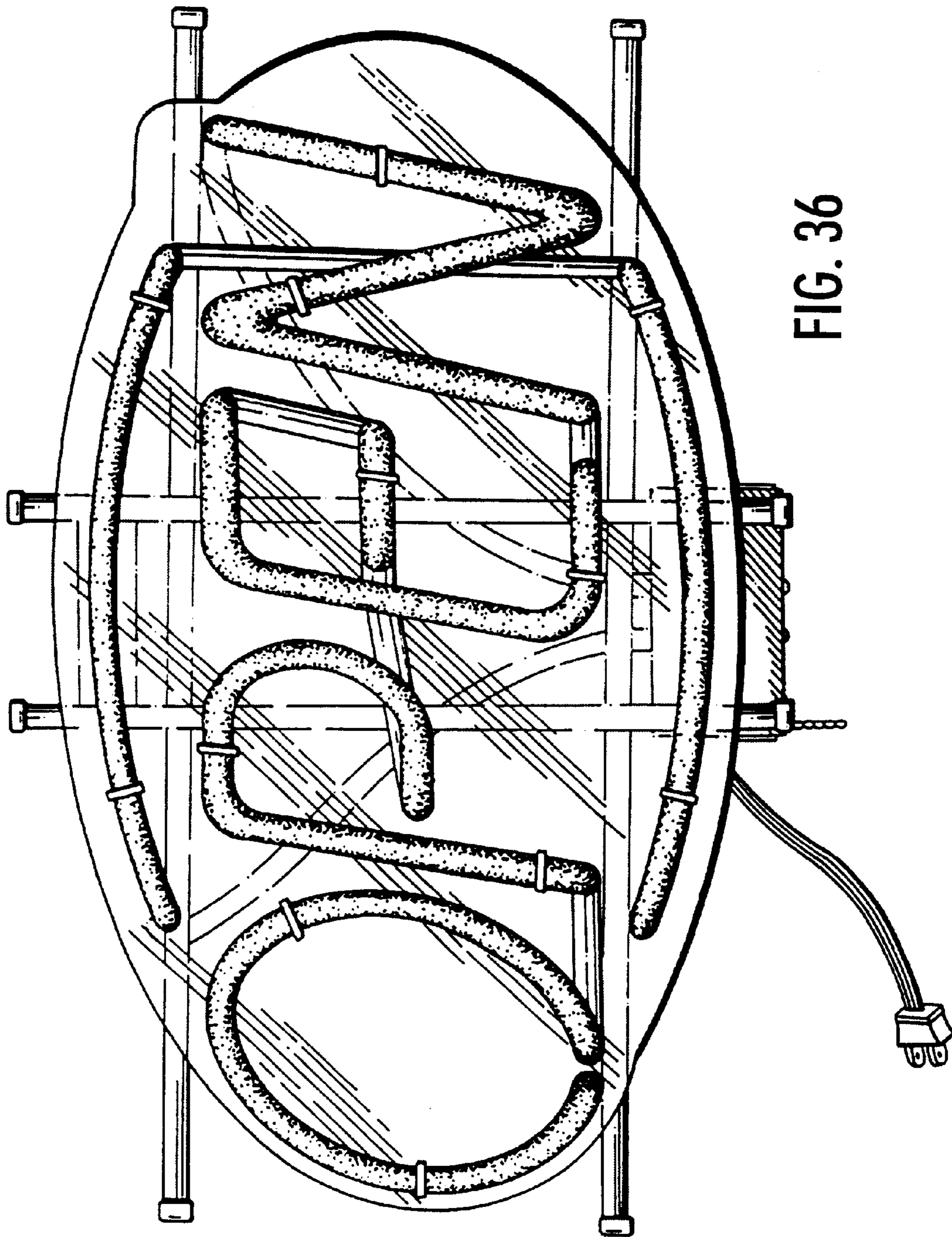

FIG. 36

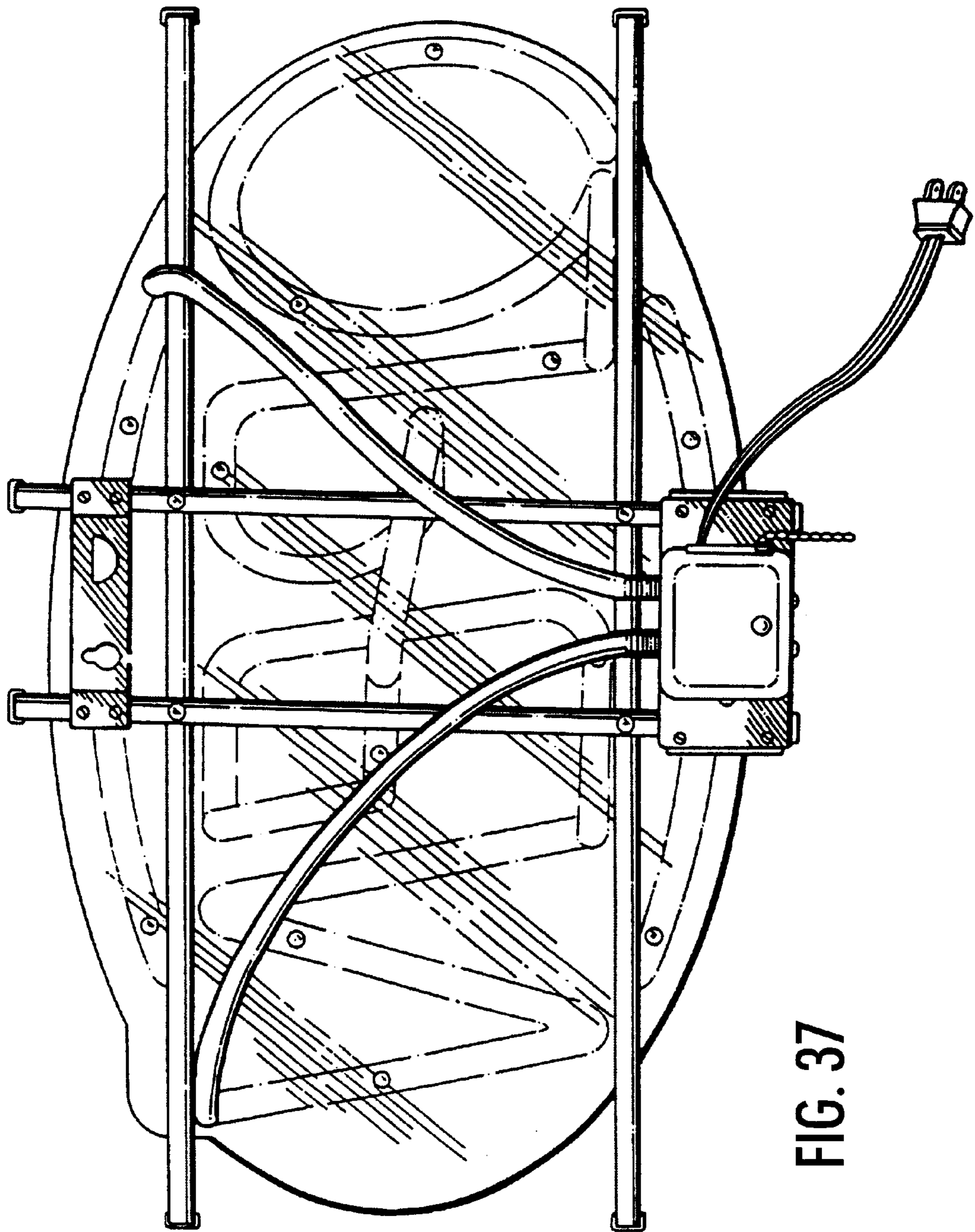

FIG. 37

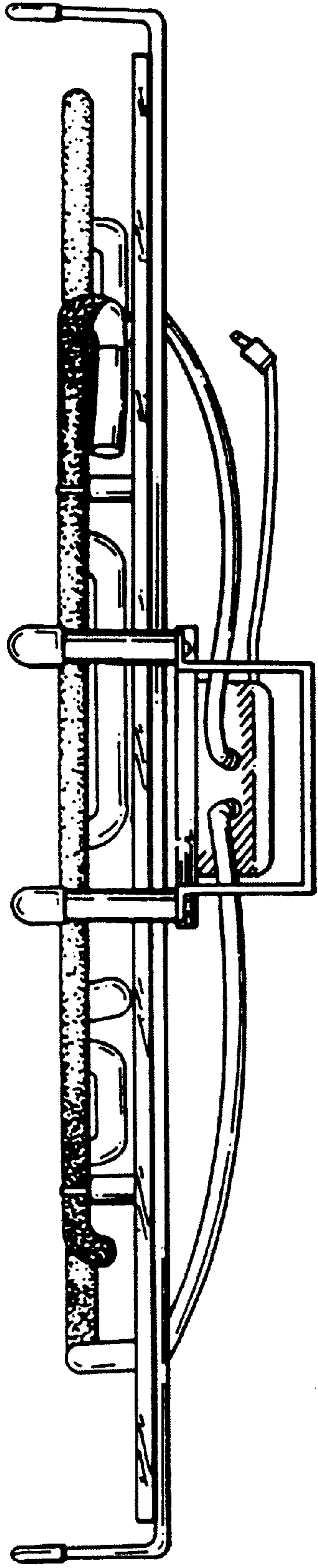

FIG. 38

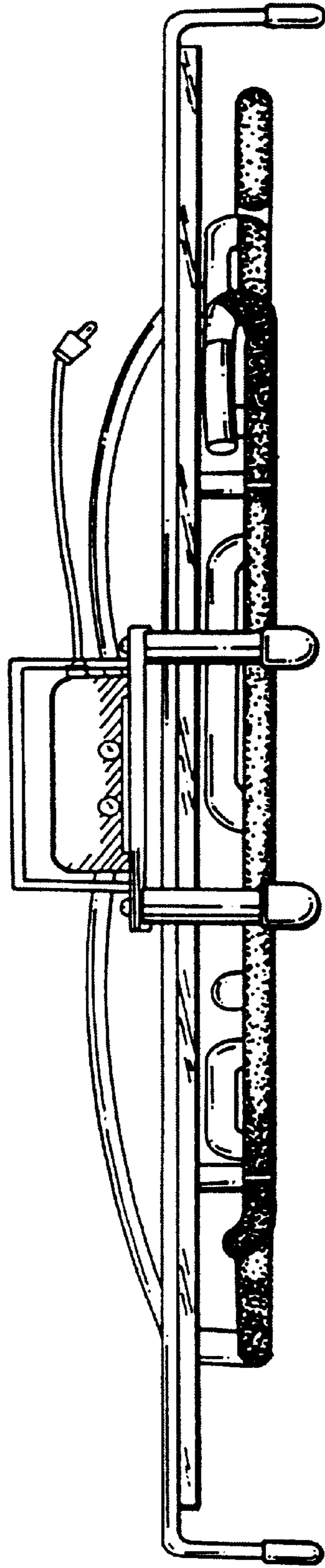

FIG. 39

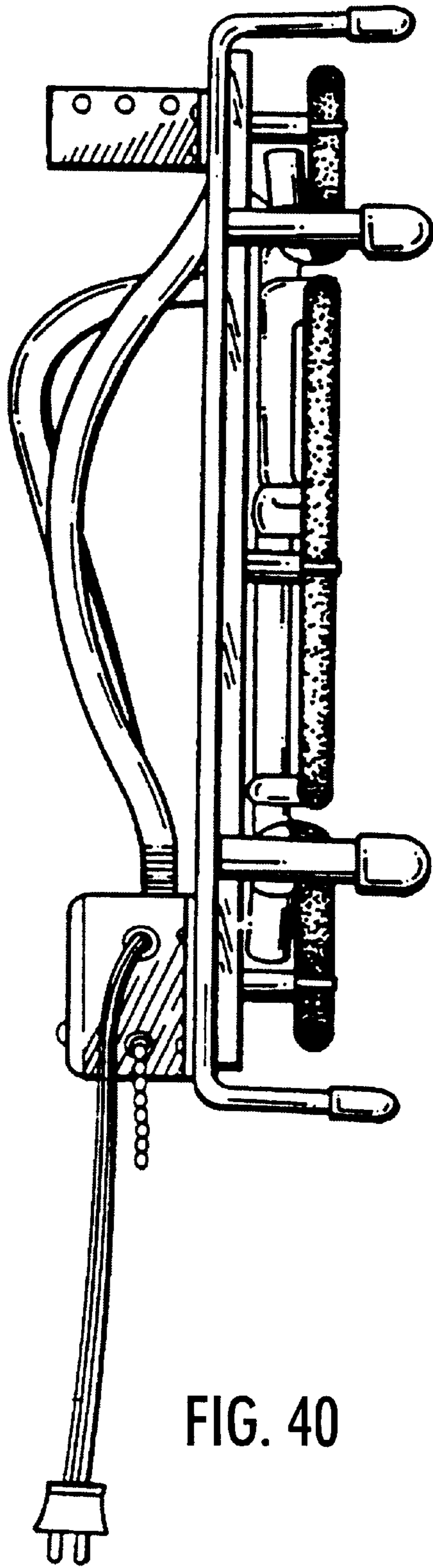

FIG. 40

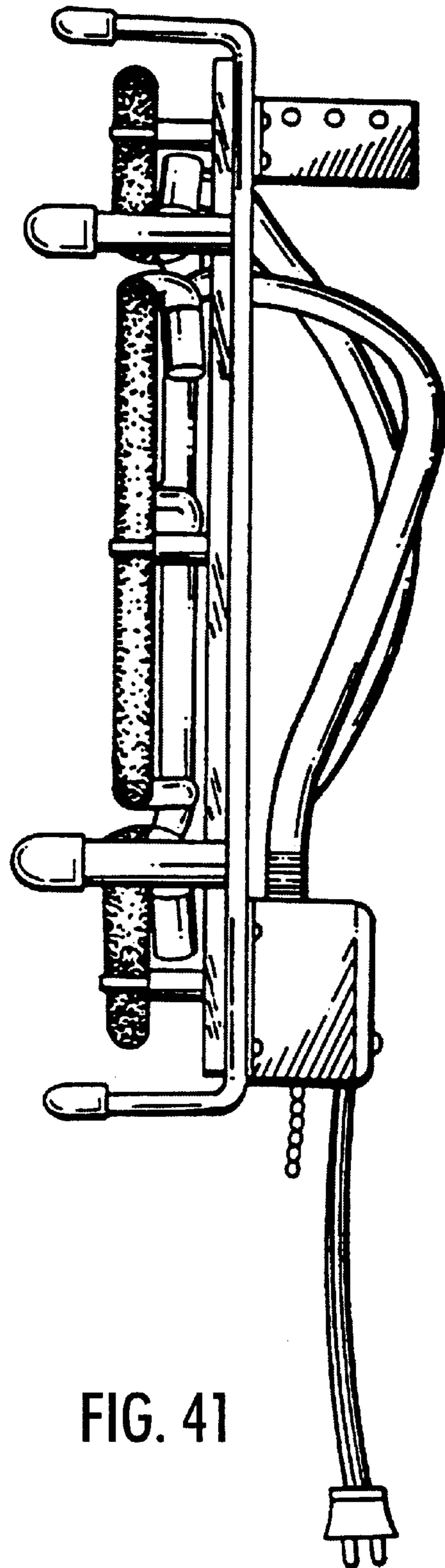

FIG. 41