



US00D476976S

(12) **United States Design Patent**
Tanabe

(10) **Patent No.:** **US D476,976 S**

(45) **Date of Patent:** **** Jul. 8, 2003**

(54) **MICROPHONE**

(75) **Inventor:** **Haruhisa Tanabe**, Yamanashi-ken (JP)

(73) **Assignee:** **Citizen Electronics Co., Ltd.**,
Yamanashi-ken (JP)

(**) **Term:** **14 Years**

(21) **Appl. No.:** **29/165,066**

(22) **Filed:** **Aug. 6, 2002**

(51) **LOC (7) Cl.** **14-01**

(52) **U.S. Cl.** **D14/225**

(58) **Field of Search** D14/206, 217,
D14/223, 225-229; 181/158, 148, 242,
199, 160, 170; 379/388, 430, 431, 419,
420.03; 381/91, 122, 151, 168, 169, 170,
189, 386

(56) **References Cited**

U.S. PATENT DOCUMENTS

3,159,719	A	*	12/1964	Weiss	381/151
3,930,560	A	*	1/1976	Carlson et al.	181/160
4,167,985	A	*	9/1979	Dunlavy	181/148
4,714,133	A	*	12/1987	Skaggs, Jr.	181/160
4,872,527	A	*	10/1989	Han	181/160
5,226,076	A	*	7/1993	Baumhauer, Jr. et al.	...	379/419

D356,571	S	*	3/1995	Garmon et al.	D14/225
D386,764	S	*	11/1997	Lake	D14/225
5,929,393	A	*	7/1999	Jeter, Jr.	181/199
5,937,074	A	*	8/1999	Carver	381/395
D414,493	S	*	9/1999	Giann-Yeong	D14/225

* cited by examiner

Primary Examiner—Paula A. Mortimer

(74) *Attorney, Agent, or Firm*—Dennison, Schultz & Dougherty

(57) **CLAIM**

The ornamental design for a microphone, as shown and described.

DESCRIPTION

FIG. 1 is a top plan view of a microphone embodying my new design;
FIG. 2 is a front view thereof;
FIG. 3 is a rear view thereof;
FIG. 4 is a bottom view thereof;
FIG. 5 is a right side view thereof;
FIG. 6 is a perspective view as viewed from a portion above the microphone; and,
FIG. 7 is a perspective view as viewed from a portion below the microphone.

1 Claim, 4 Drawing Sheets

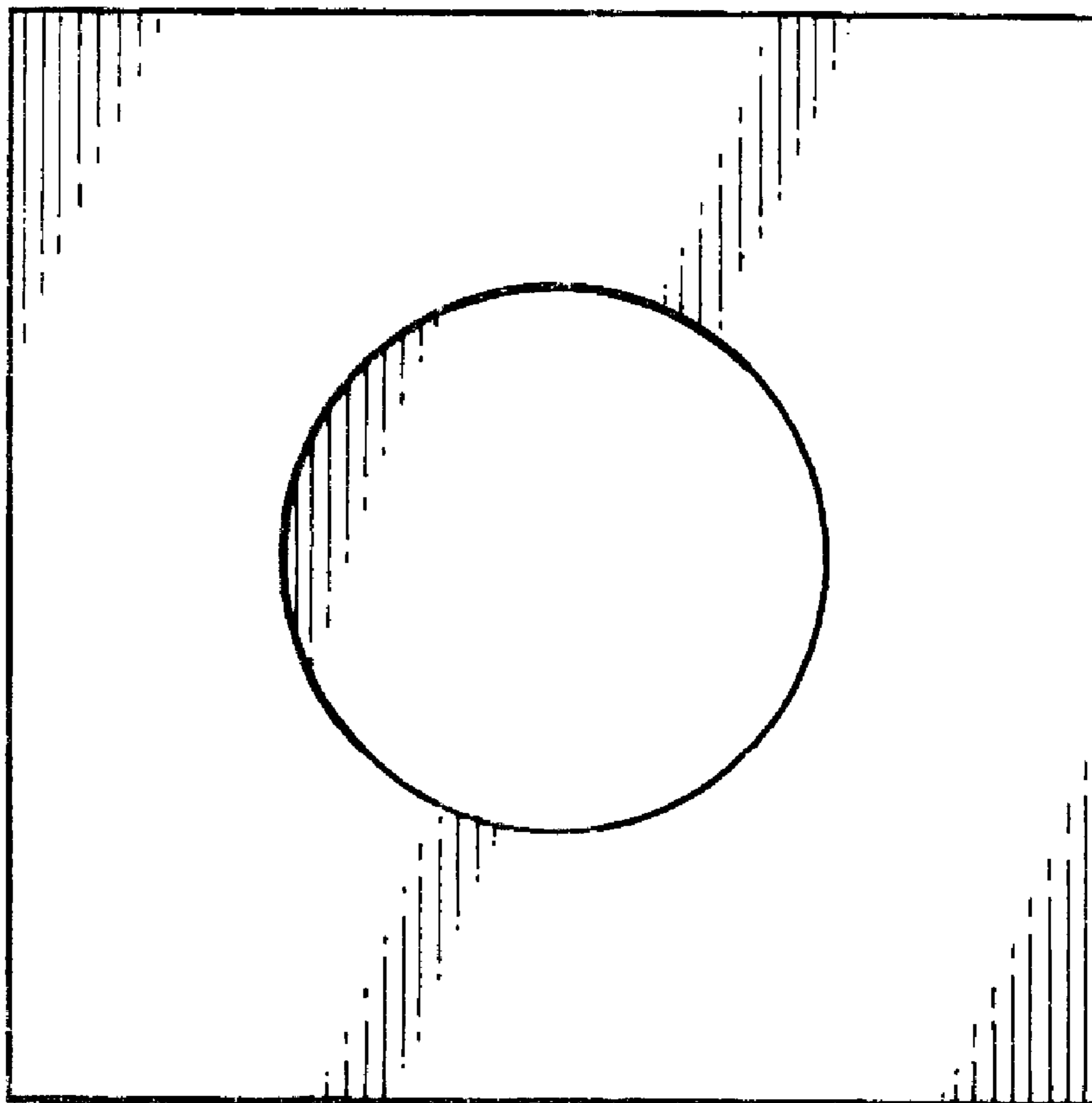

Fig. 1

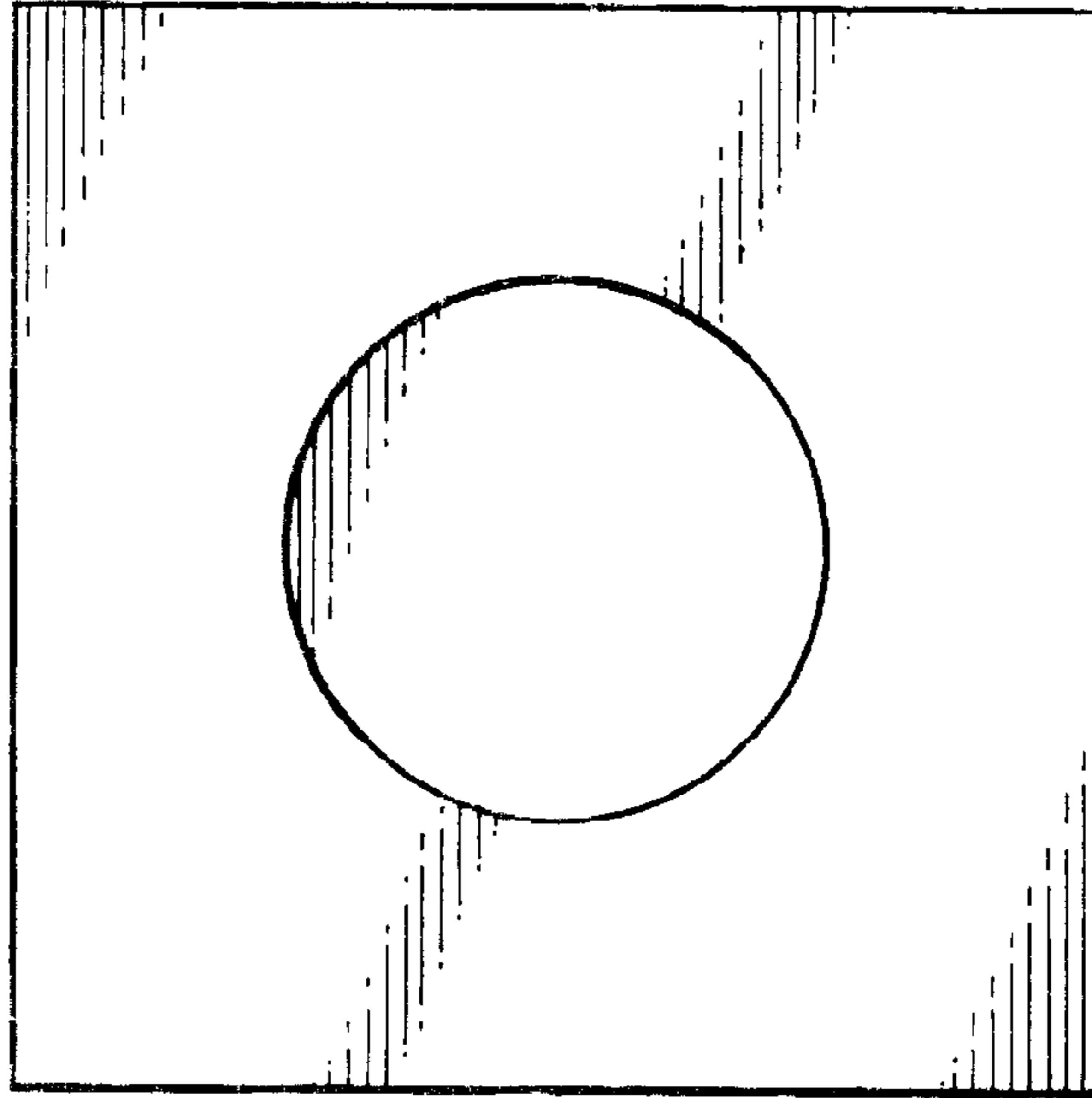

Fig. 2

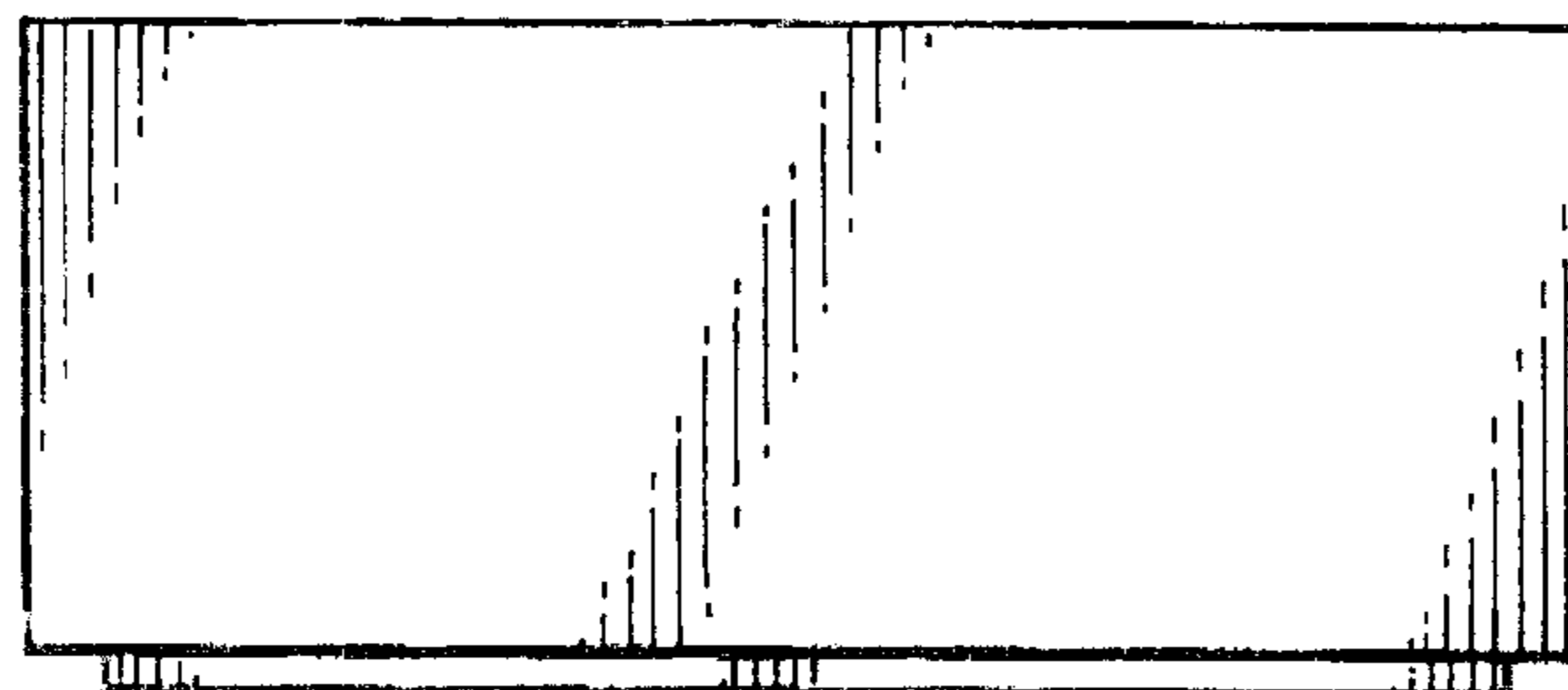

Fig. 3

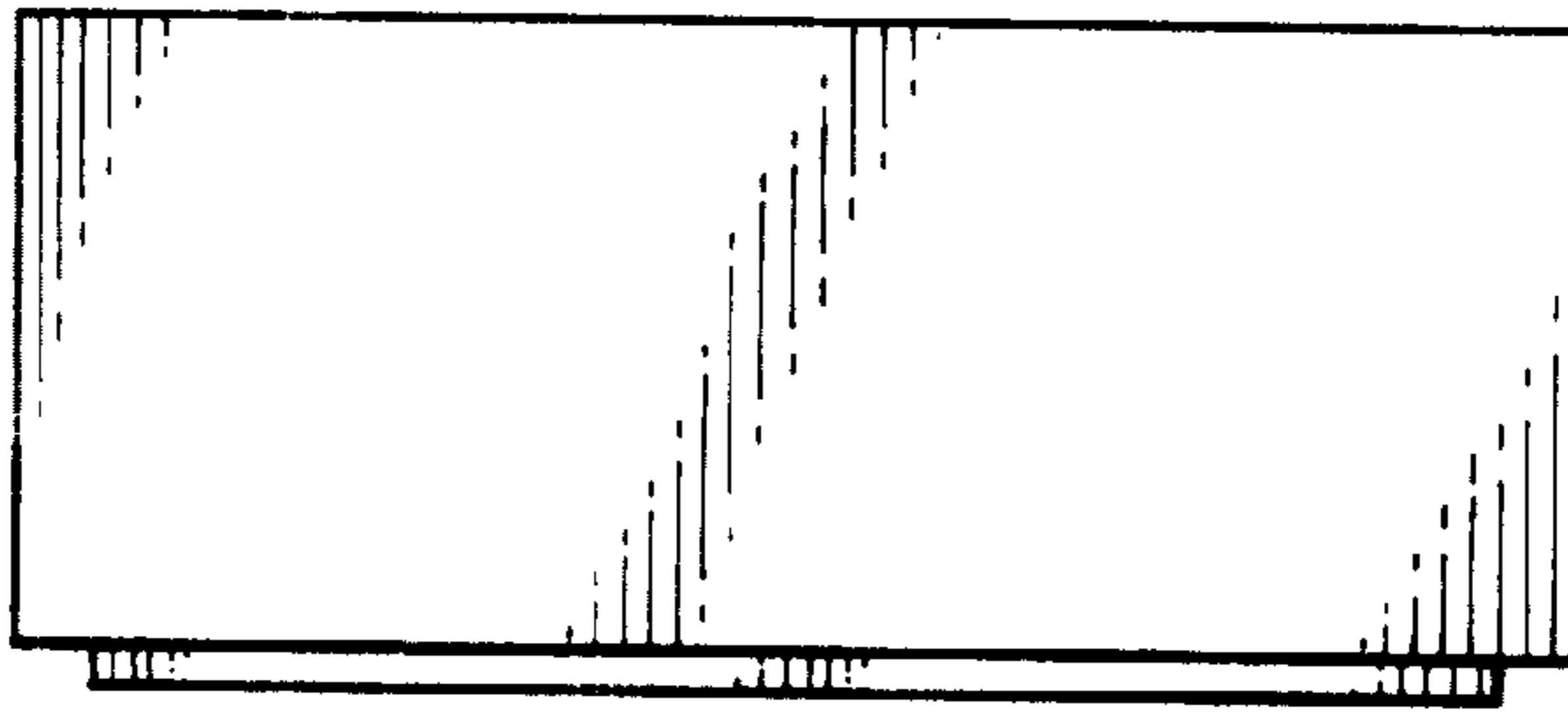

Fig. 4

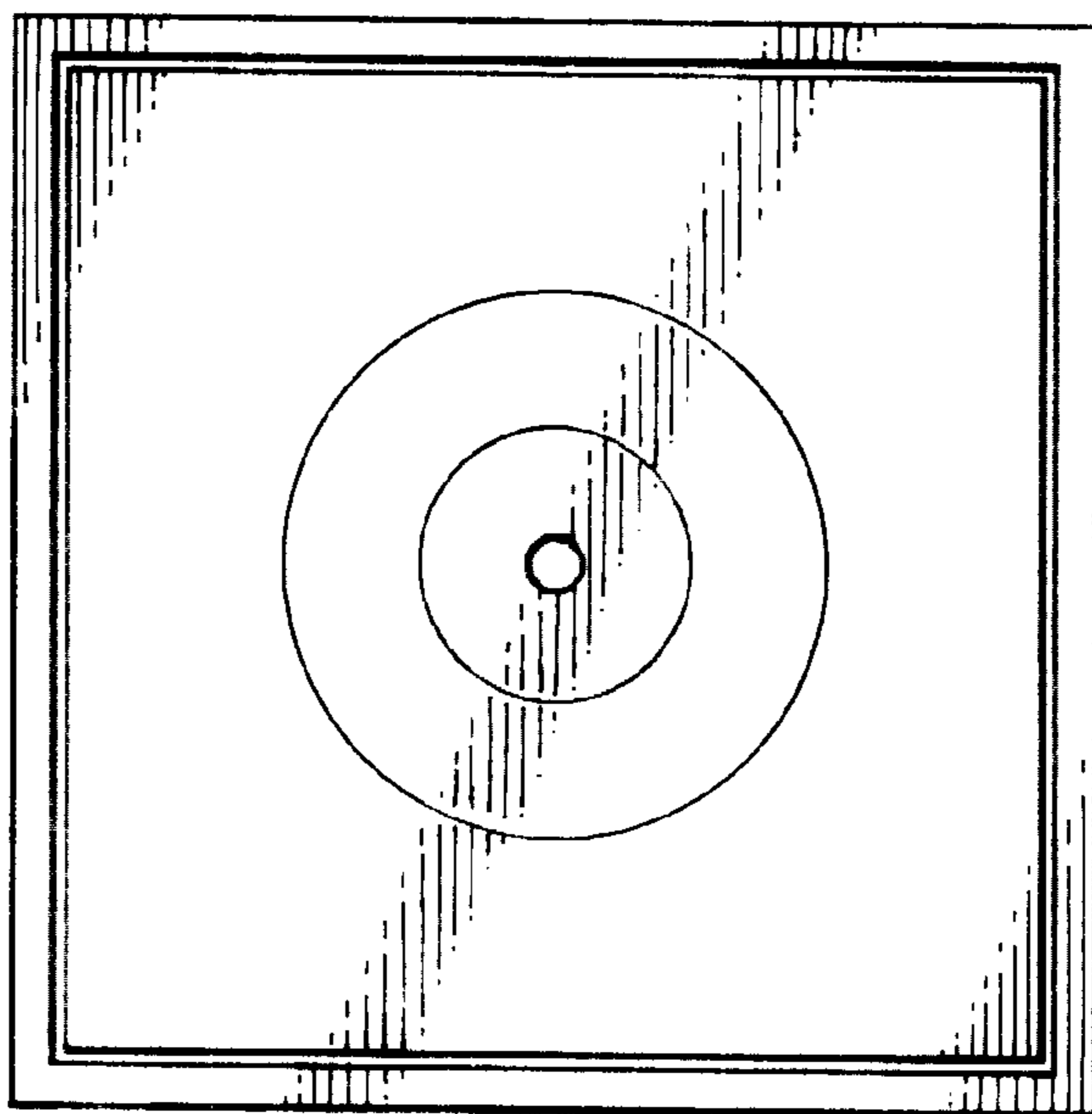

Fig. 5

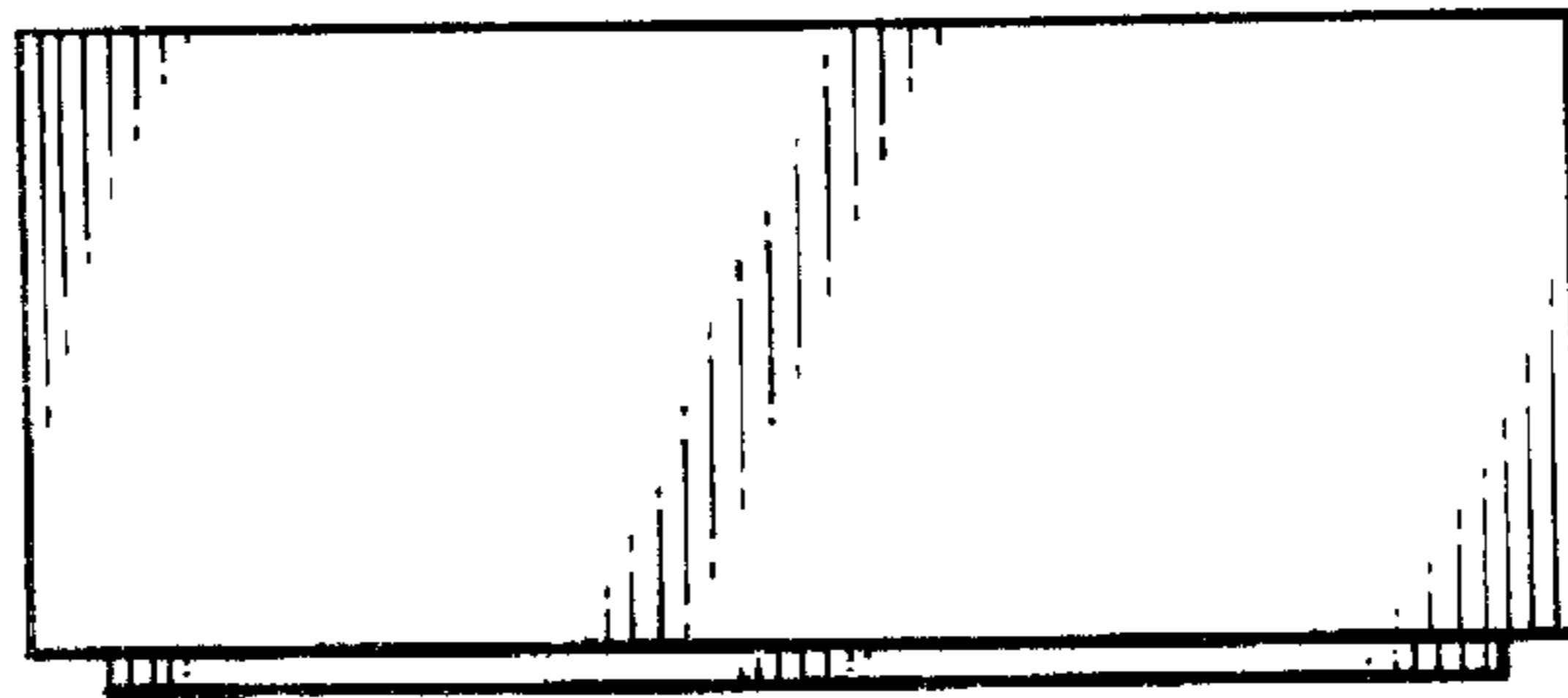

Fig. 6

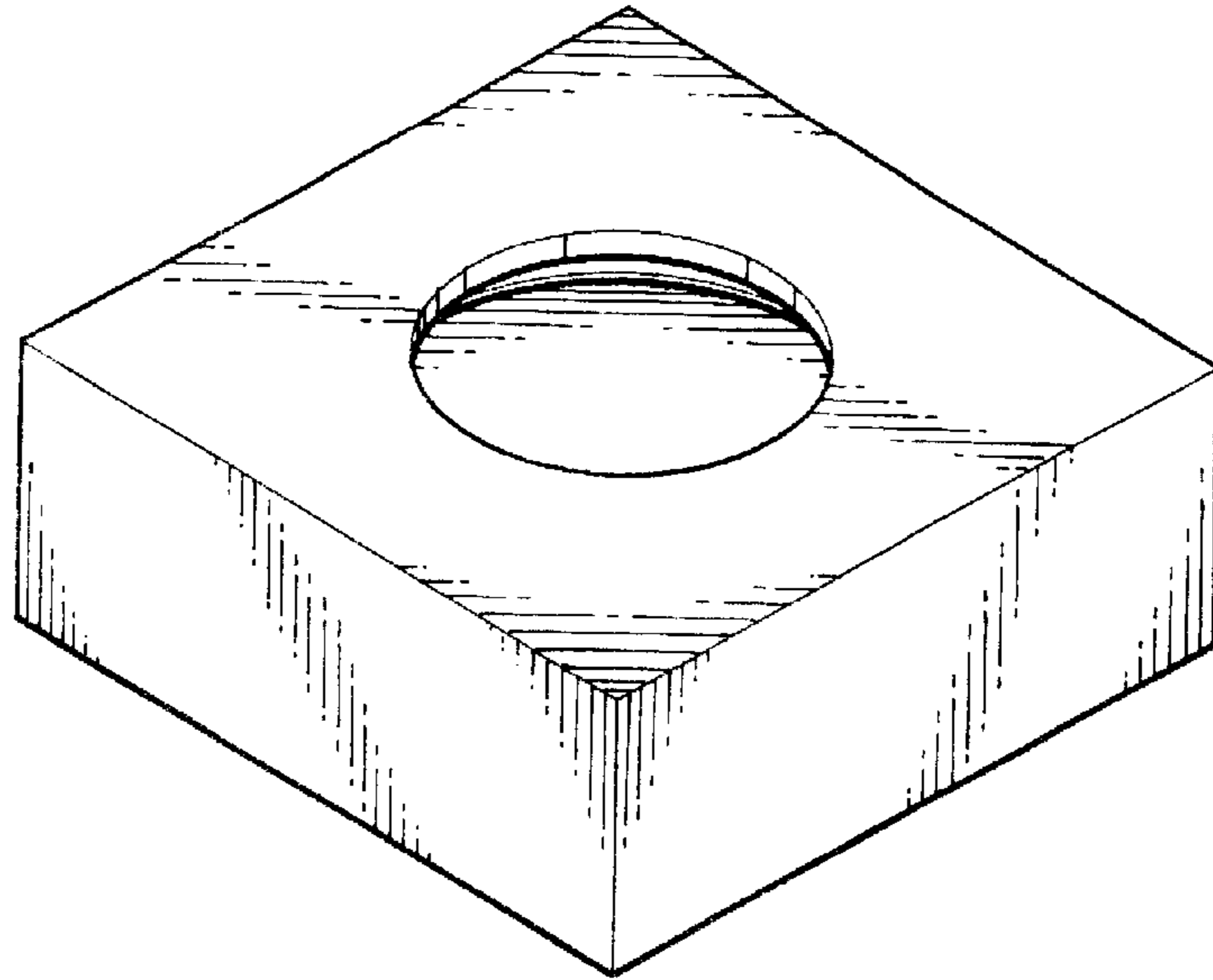

Fig. 7

