



US00D476969S

(12) **United States Design Patent**
Weidinger

(10) **Patent No.:** **US D476,969 S**

(45) **Date of Patent:** **** Jul. 8, 2003**

(54) **TELEPHONE**

(75) **Inventor:** **Joseph Weidinger, Phoenix, AZ (US)**

(73) **Assignee:** **Inter-Tel, Inc., Tempe, AZ (US)**

(**) **Term:** **14 Years**

(21) **Appl. No.:** **29/171,557**

(22) **Filed:** **Nov. 25, 2002**

Related U.S. Application Data

(62) Division of application No. 29/154,320, filed on Jan. 22, 2002, now Pat. No. Des. 470,830.

(51) **LOC (7) Cl.** **14-03**

(52) **U.S. Cl.** **D14/151**

(58) **Field of Search** D14/434, 329,
D14/330, 447, 148, 147, 149-151, 140-142,
240, 241, 251, 253, 130; 379/420.01, 420.02,
420.03, 419, 420.04, 428.02, 428.01, 428.04,
428.03, 454, 440, 446, 434-436; D13/107,
108; 320/110, 113, 114, 115

(56) **References Cited**

U.S. PATENT DOCUMENTS

- D270,836 S * 10/1983 Breger D14/151
- D273,108 S * 3/1984 Breger D14/151
- D284,469 S * 7/1986 Ando D14/151
- D284,571 S * 7/1986 Marshall D14/151
- D286,777 S * 11/1986 Bishop D14/151
- D287,361 S * 12/1986 Sekiguchi et al. D14/151
- D297,137 S * 8/1988 Richter et al. D14/151
- D307,145 S * 4/1990 Oshima et al. D14/241
- D313,235 S * 12/1990 Kido et al. D14/241
- 5,121,427 A * 6/1992 Gumb et al. 379/435
- D328,295 S * 7/1992 Gagnon et al. D14/142
- D332,786 S * 1/1993 Gagnon D14/142
- 5,187,743 A * 2/1993 Gumb et al. 379/436

- D340,715 S * 10/1993 Desbarats D14/151
- D345,358 S * 3/1994 Hillenmayer et al. D14/151
- D363,285 S * 10/1995 Vessey et al. D14/151
- D368,091 S * 3/1996 Yoshihiko et al. D14/151
- D375,094 S * 10/1996 Toh D14/151
- D387,056 S * 12/1997 Yoneyama D14/151
- D389,145 S * 1/1998 Yoneyama D14/151
- D390,226 S * 2/1998 Mak et al. D14/149
- D395,308 S * 6/1998 Yoneyama D14/151
- 5,761,297 A * 6/1998 Kingsbury et al. 379/428
- D412,171 S * 7/1999 Girardi et al. D14/151
- D423,497 S * 4/2000 Nogas D14/151
- D432,512 S * 10/2000 Raz D14/151
- D433,399 S * 11/2000 Seki et al. D14/151
- D437,840 S * 2/2001 Korby et al. D14/151
- D439,231 S * 3/2001 Song D14/144
- D449,287 S * 10/2001 Jauregui et al. D14/151
- D451,486 S * 12/2001 Sekiguchi D14/151
- D452,489 S * 12/2001 Nagase D14/151
- D457,509 S * 5/2002 Ohwada et al. D14/151
- D460,954 S * 7/2002 Shen et al. D14/151

* cited by examiner

Primary Examiner—Jeffrey Asch

(74) *Attorney, Agent, or Firm*—Michelle Whittington

(57) **CLAIM**

The ornamental design for a telephone, as shown.

DESCRIPTION

FIG. 1 is a perspective top view of a telephone showing my new design;
 FIG. 2 is a left side view thereof;
 FIG. 3 is a right side view thereof;
 FIG. 4 is a front view thereof;
 FIG. 5 is a rear view thereof;
 FIG. 6 is a bottom perspective view thereof; and,
 FIG. 7 is a bottom view thereof.

1 Claim, 7 Drawing Sheets

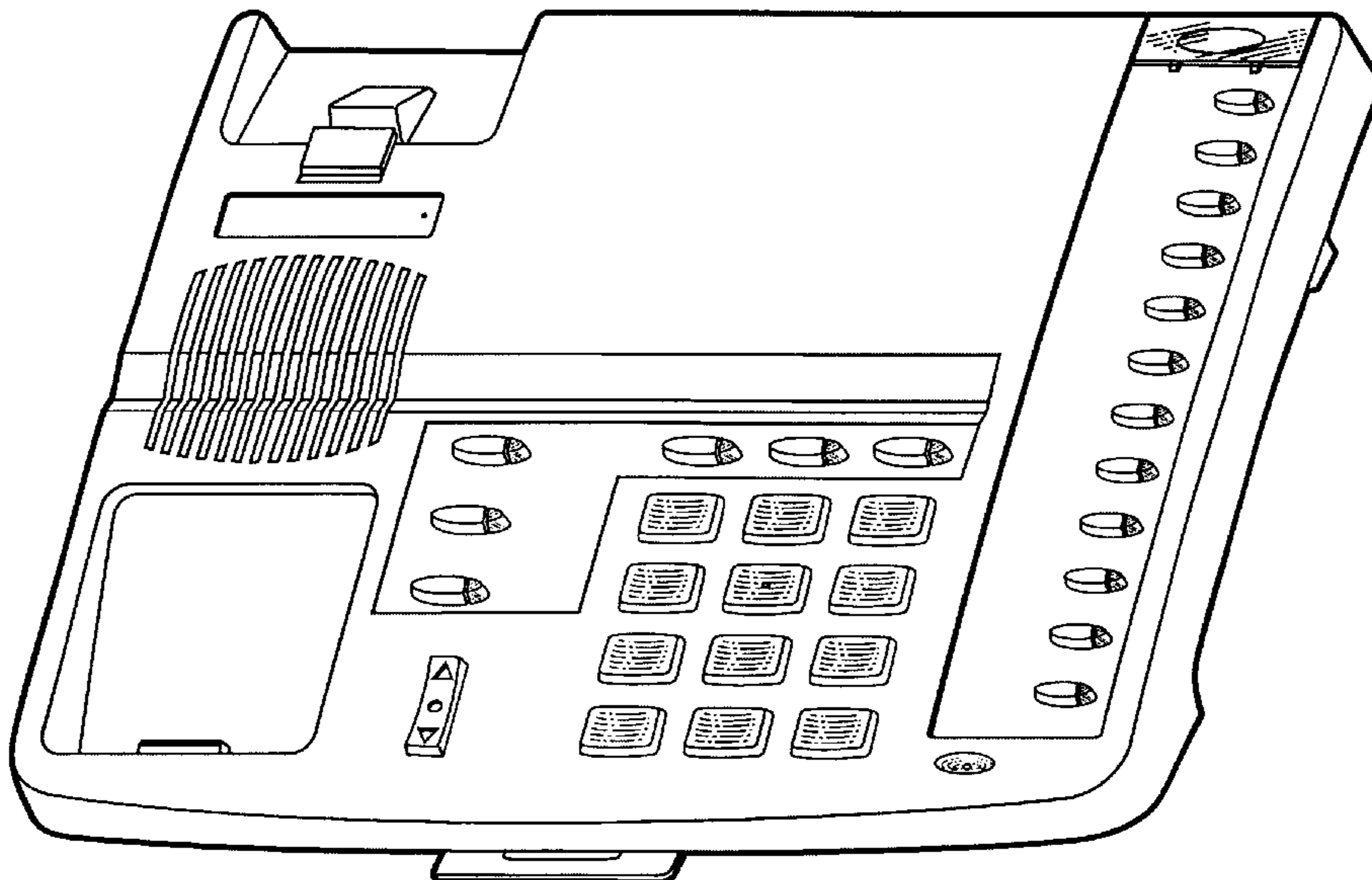

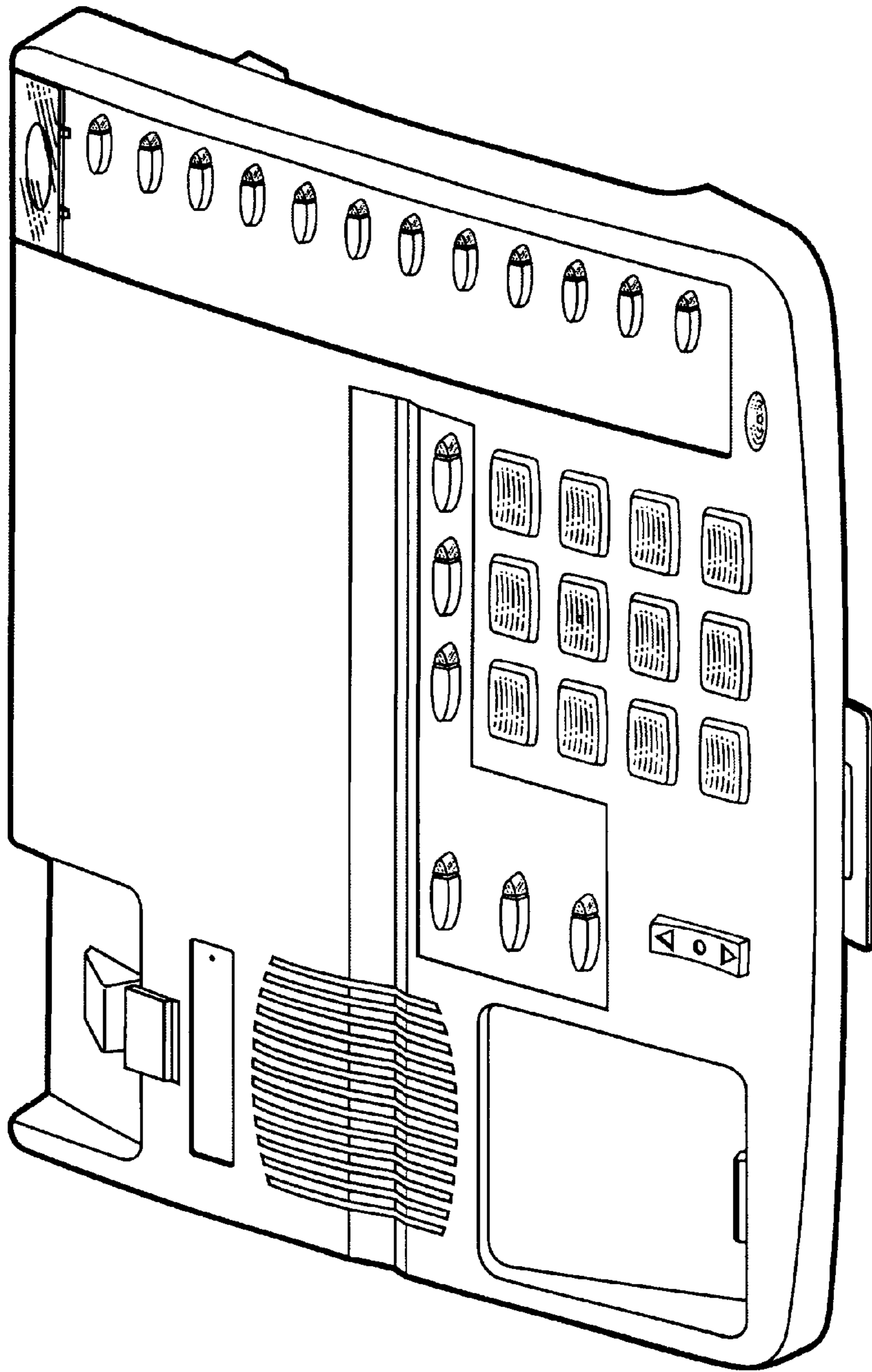

Fig. 1

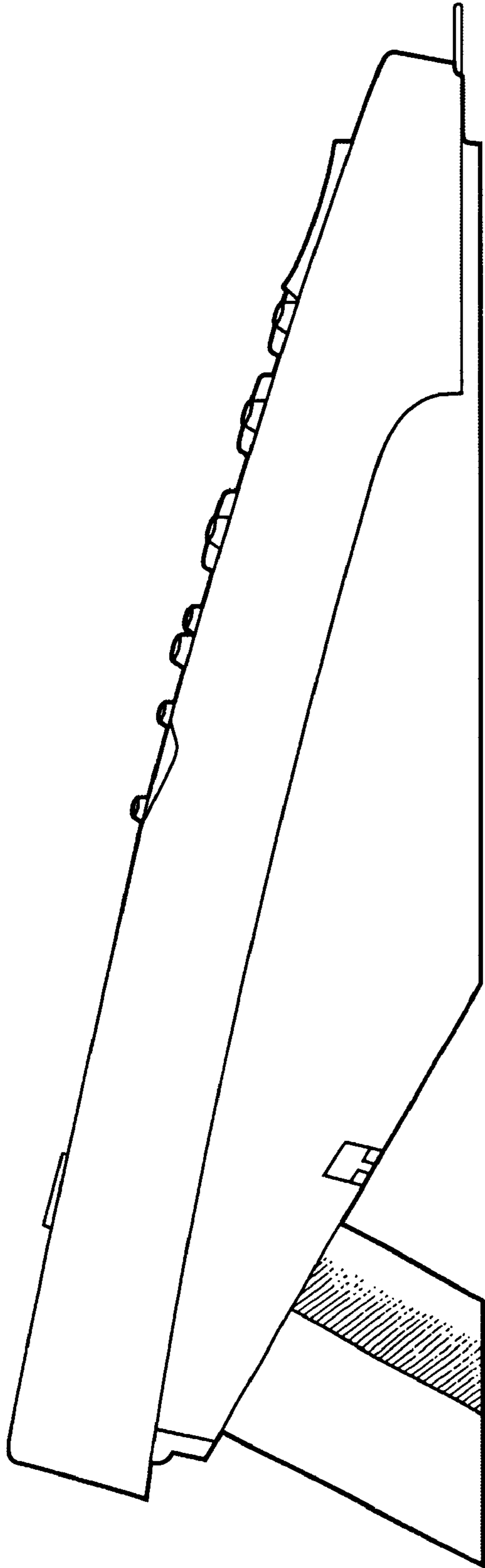

Fig. 2

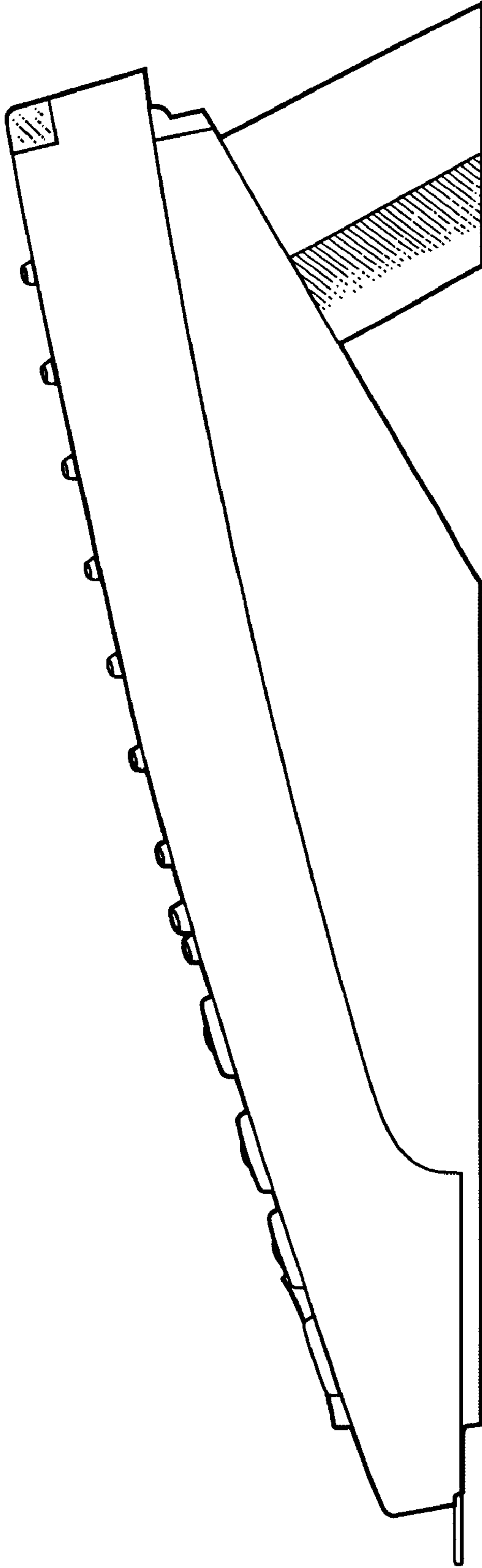

Fig. 3

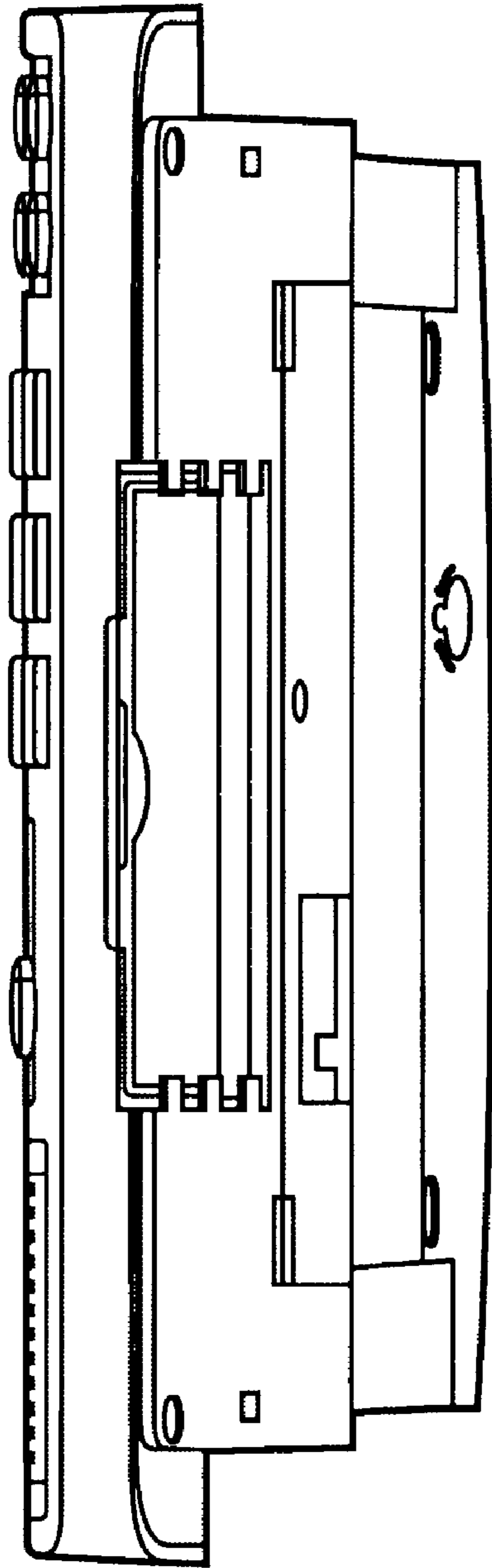

Fig. 4

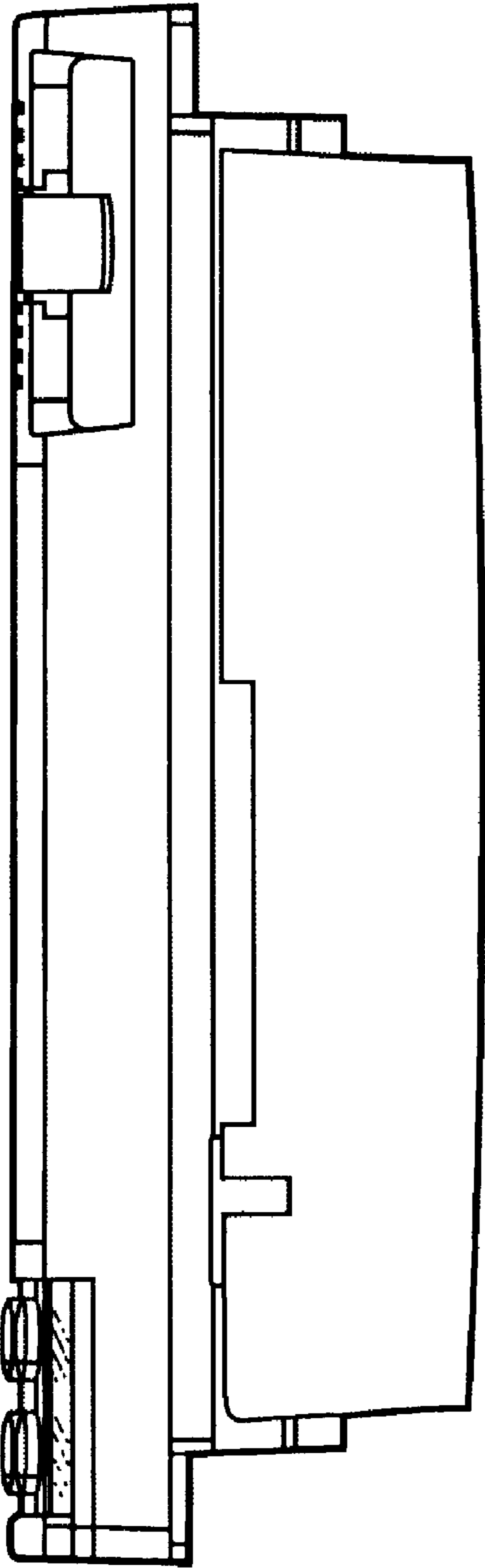

Fig. 5

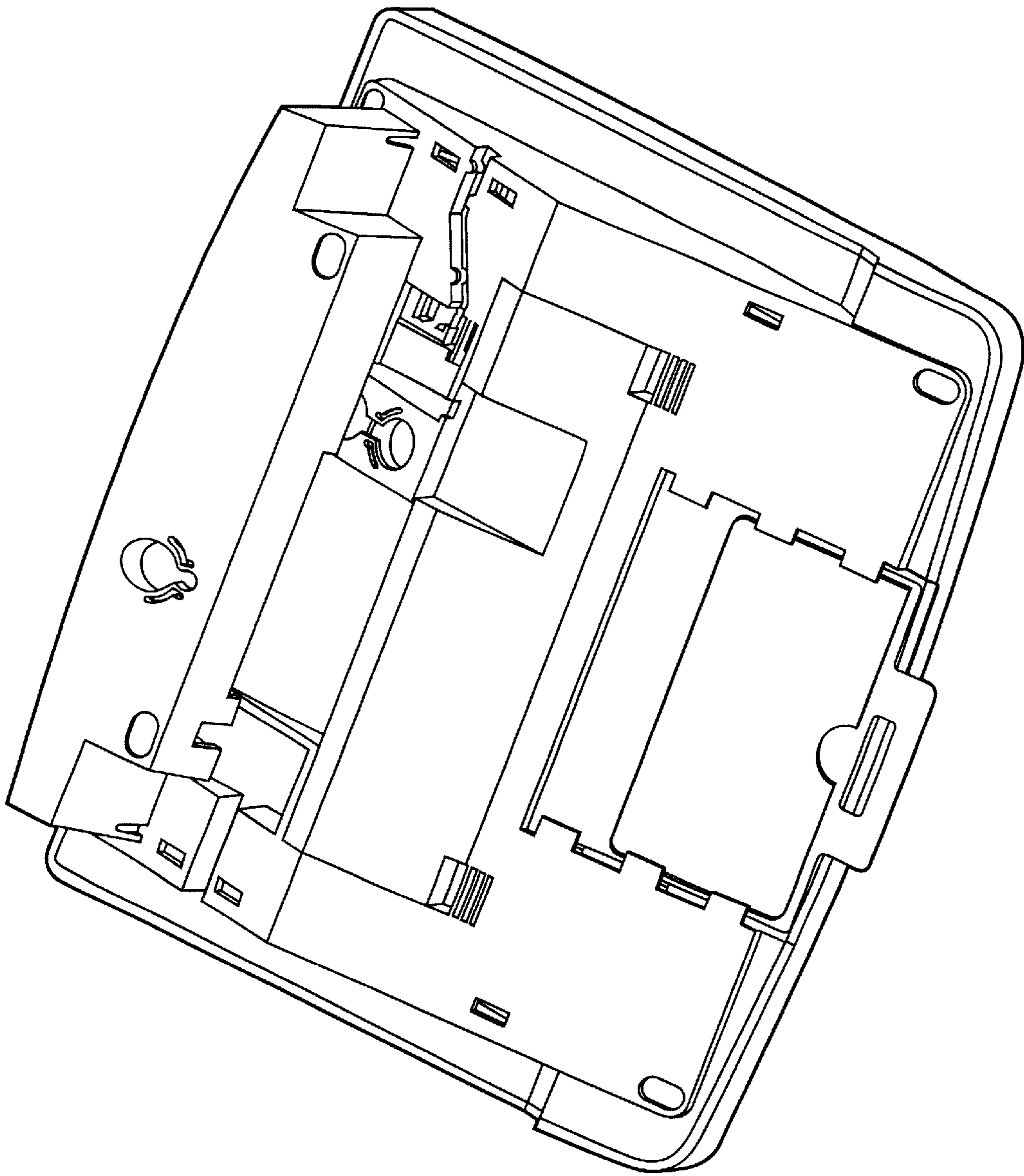

Fig. 6

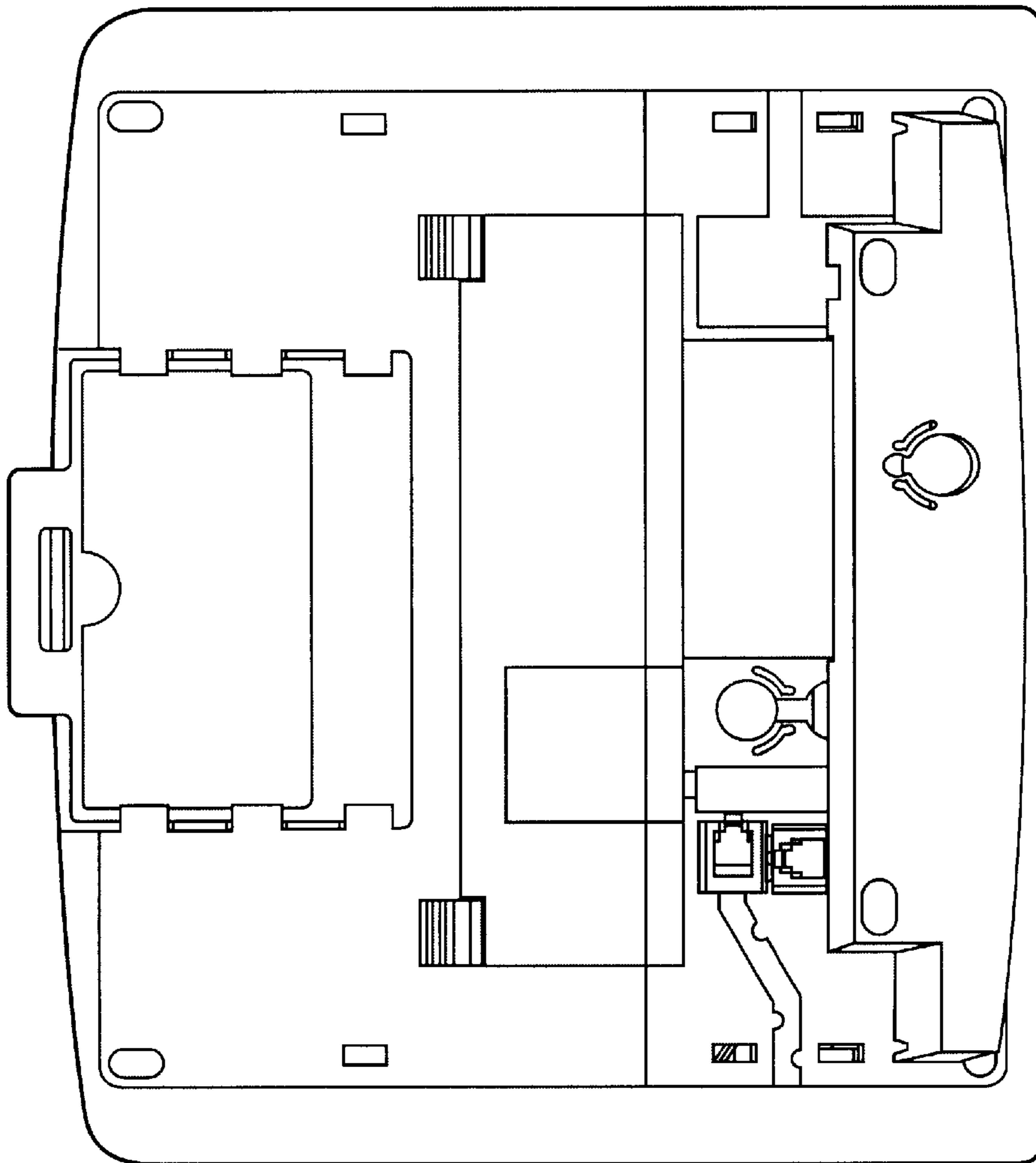

Fig. 7