



US00D476913S

(12) **United States Design Patent**
Blackman et al.

(10) **Patent No.:** **US D476,913 S**

(45) **Date of Patent:** **** Jul. 8, 2003**

(54) **TAPE MEASURE HOUSING**

6,470,590 B1 * 10/2002 Lee 33/767
6,491,248 B1 * 12/2002 Liu 33/767 X

(75) Inventors: **William C. Blackman**, Raleigh, NC
(US); **Renfred K. McDaniel**, Clayton,
NC (US); **James P. Edwards, Jr.**,
Raleigh, NC (US)

OTHER PUBLICATIONS

Stanley Web Page Product Brochure; Product No. 33-735—
35'×1-¼" FatMax Tape Rule; 2 pages.
Stanley Web Page Product Brochure; Product No. 33-730—
30'×1-¼" FatMax Tape Rule with Blade Armor; 2 pages.
Stanley Web Page Product Brochure; Product No. 33-728—
8m×1-¼" FatMax Metric Tape Rule; 2 pages.

(73) Assignee: **Cooper Brands, Inc.**, Houston, TX
(US)

(**) Term: **14 Years**

* cited by examiner

(21) Appl. No.: **29/168,630**

Primary Examiner—Antoine Duval Davis

(22) Filed: **Oct. 4, 2002**

(74) *Attorney, Agent, or Firm*—Coats & Bennett, PLLC

(51) **LOC (7) Cl.** **10-04**

(57) **CLAIM**

(52) **U.S. Cl.** **D10/72**

The ornamental design for a tape measure housing, as shown
and described.

(58) **Field of Search** D10/72; 33/755-770

(56) **References Cited**

DESCRIPTION

U.S. PATENT DOCUMENTS

D342,459 S	12/1993	Shen	
D347,395 S	5/1994	Yang	
5,746,004 A	5/1998	Wertheim	
D399,149 S	* 10/1998	Bennett D10/72
D414,123 S	* 9/1999	Liu D10/72
D420,605 S	2/2000	Caplan et al.	
D433,344 S	11/2000	Hsu	
D447,712 S	9/2001	Hsu	
D454,081 S	3/2002	Hsu	
6,382,547 B1	* 5/2002	Yang 33/769 X
6,431,486 B1	* 8/2002	Lee 33/767 X

FIG. 1 is a perspective view of one embodiment of the tape
measure housing in accordance with the present invention.
FIG. 2 is a left view of the embodiment of FIG. 1.
FIG. 3 is a right view of the embodiment of FIG. 1.
FIG. 4 is a back view of the embodiment of FIG. 1.
FIG. 5 is a front view of the embodiment of FIG. 1.
FIG. 6 is a bottom view of the embodiment of FIG. 1; and,
FIG. 7 is a top view of the embodiment of FIG. 1.
Throughout the Figures, aspects shown in broken lines are
not considered a portion of the claimed ornamental design.

1 Claim, 4 Drawing Sheets

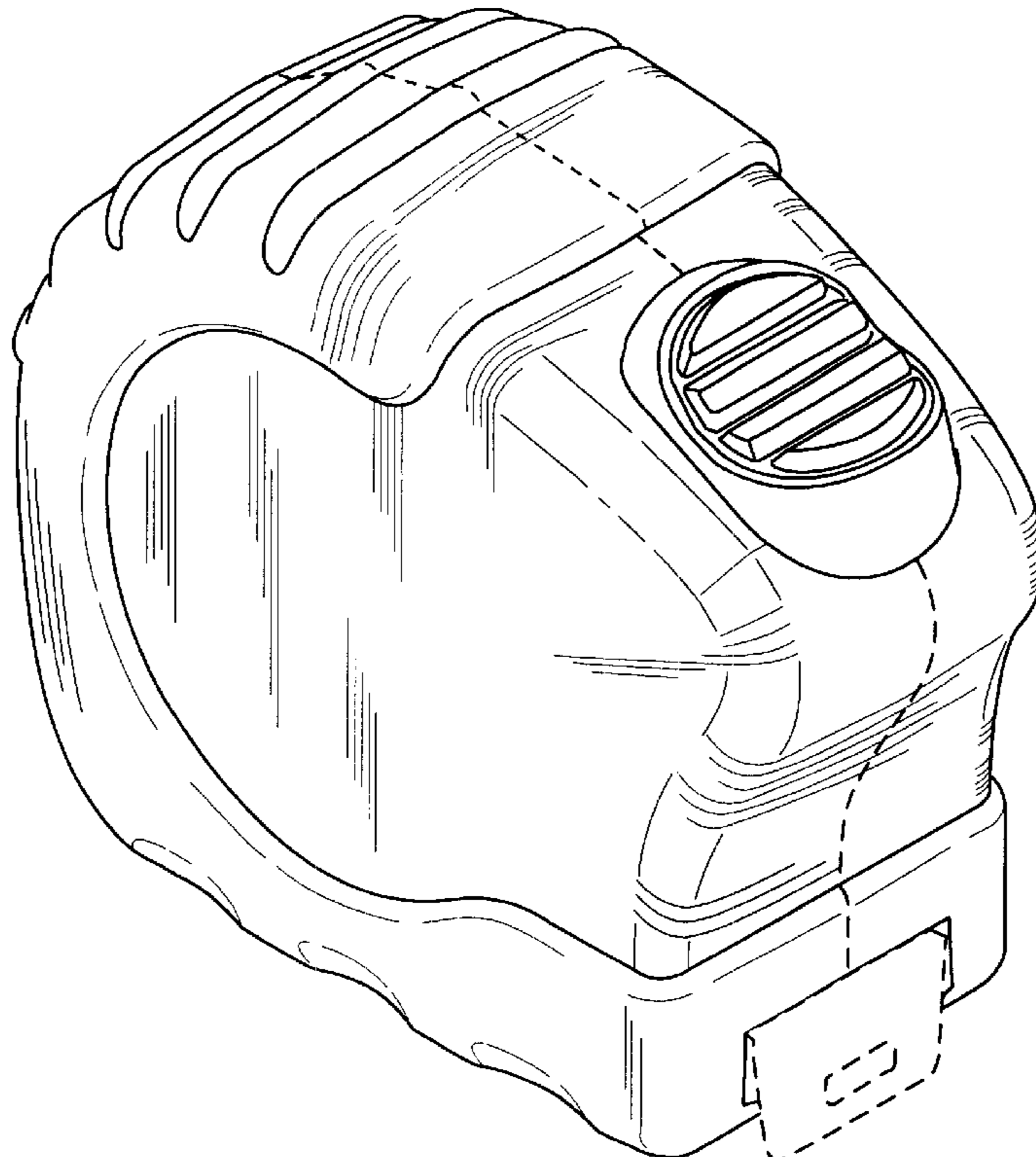

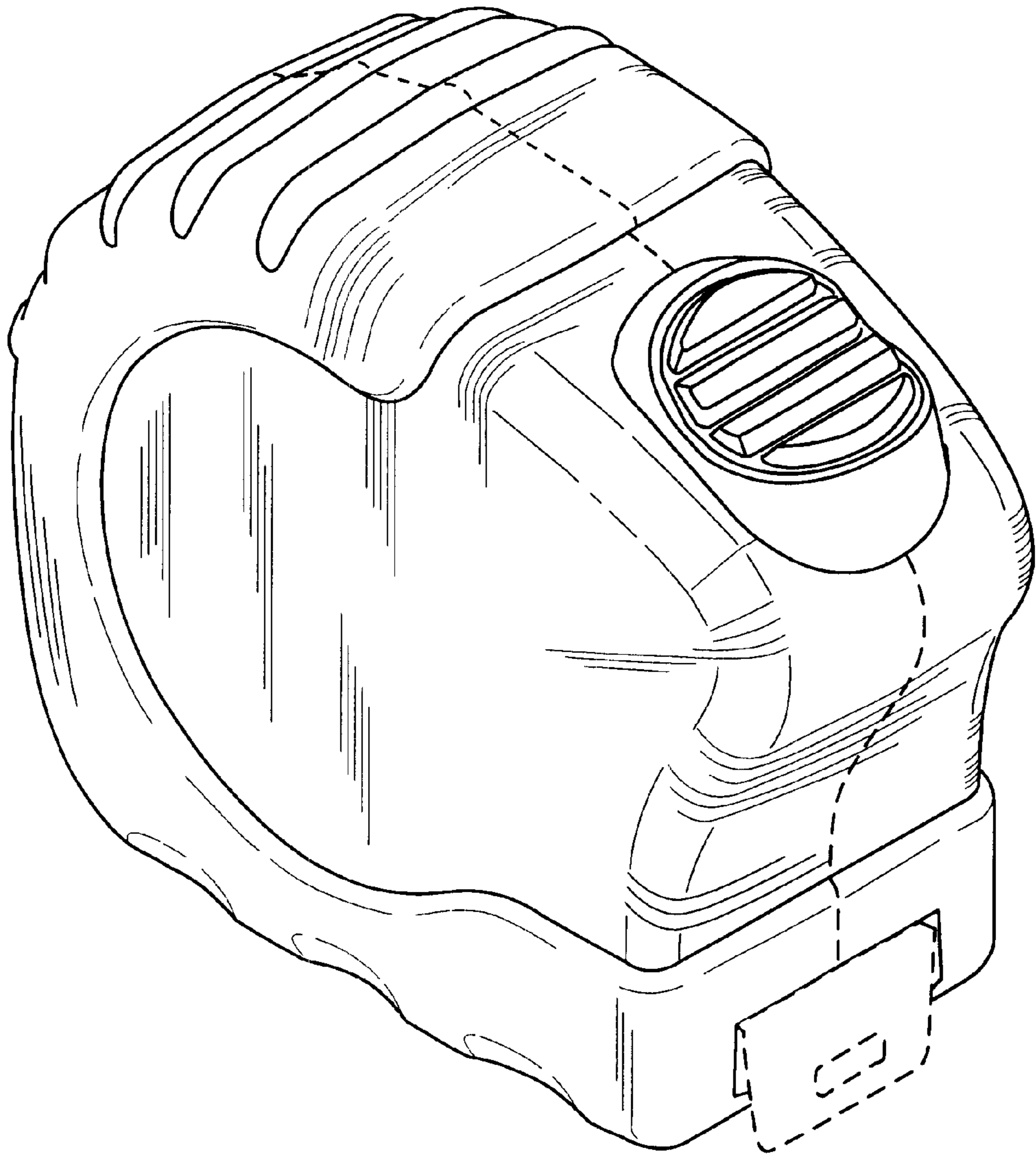

FIG. 1

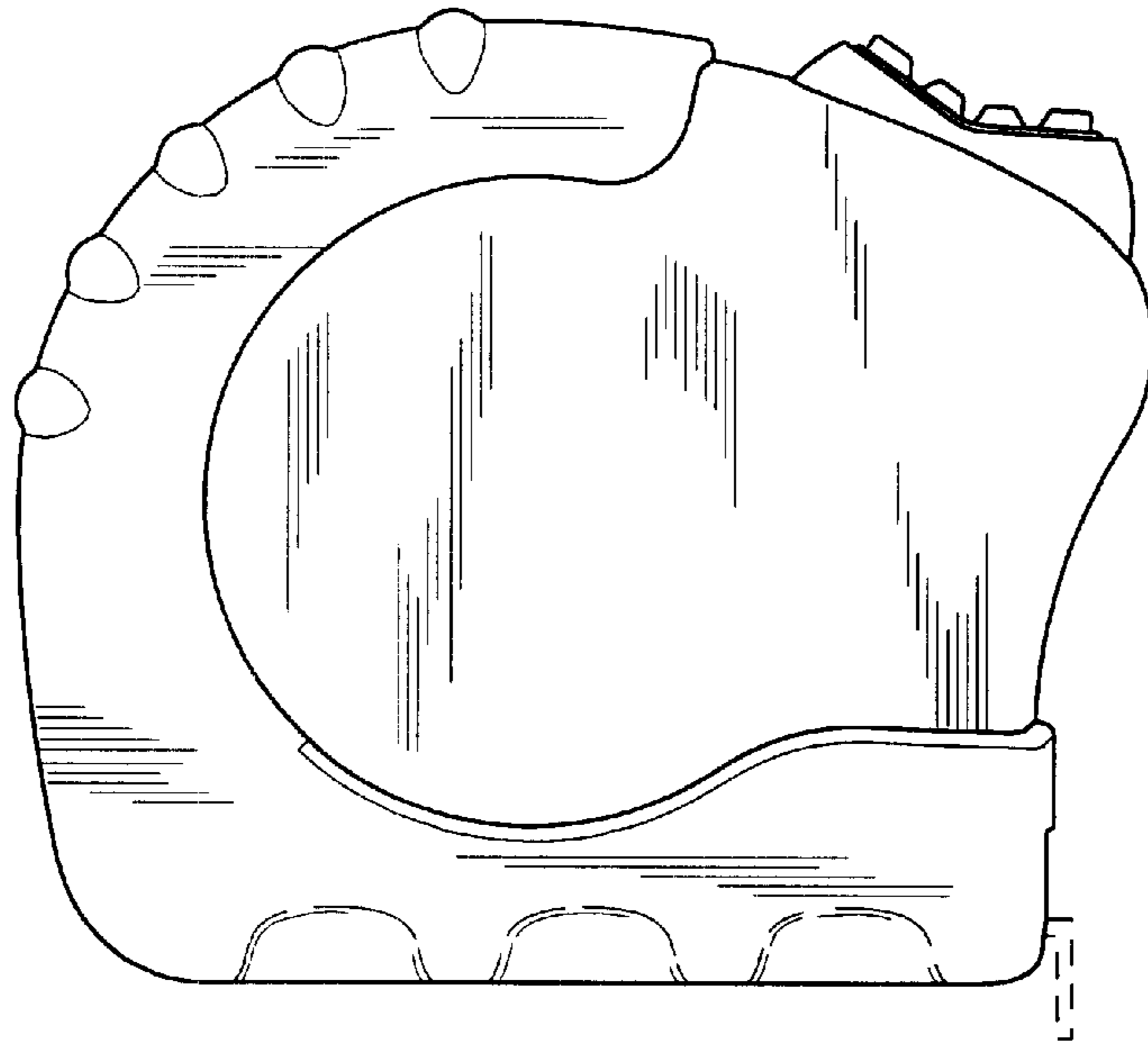

FIG. 2

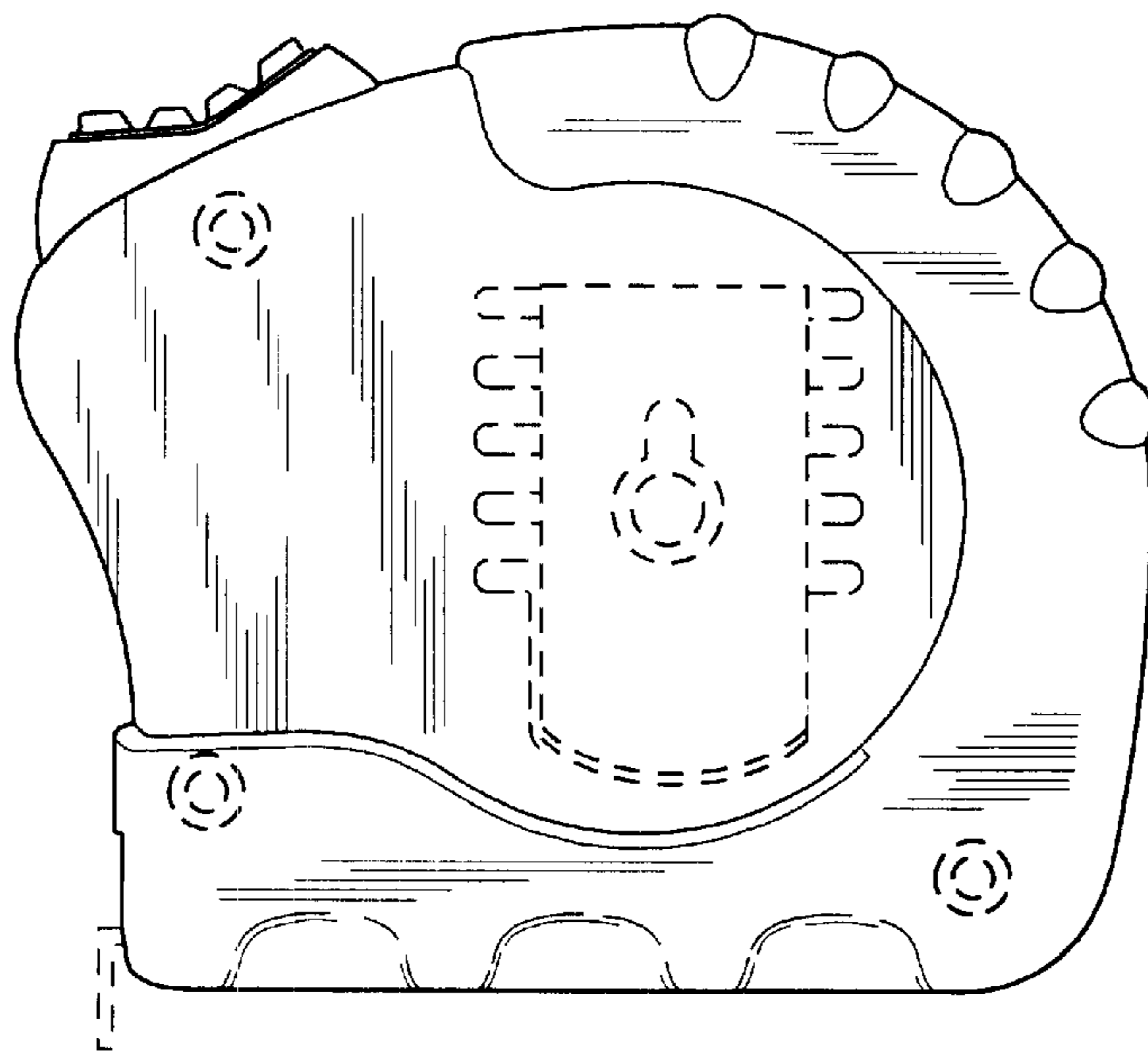

FIG. 3

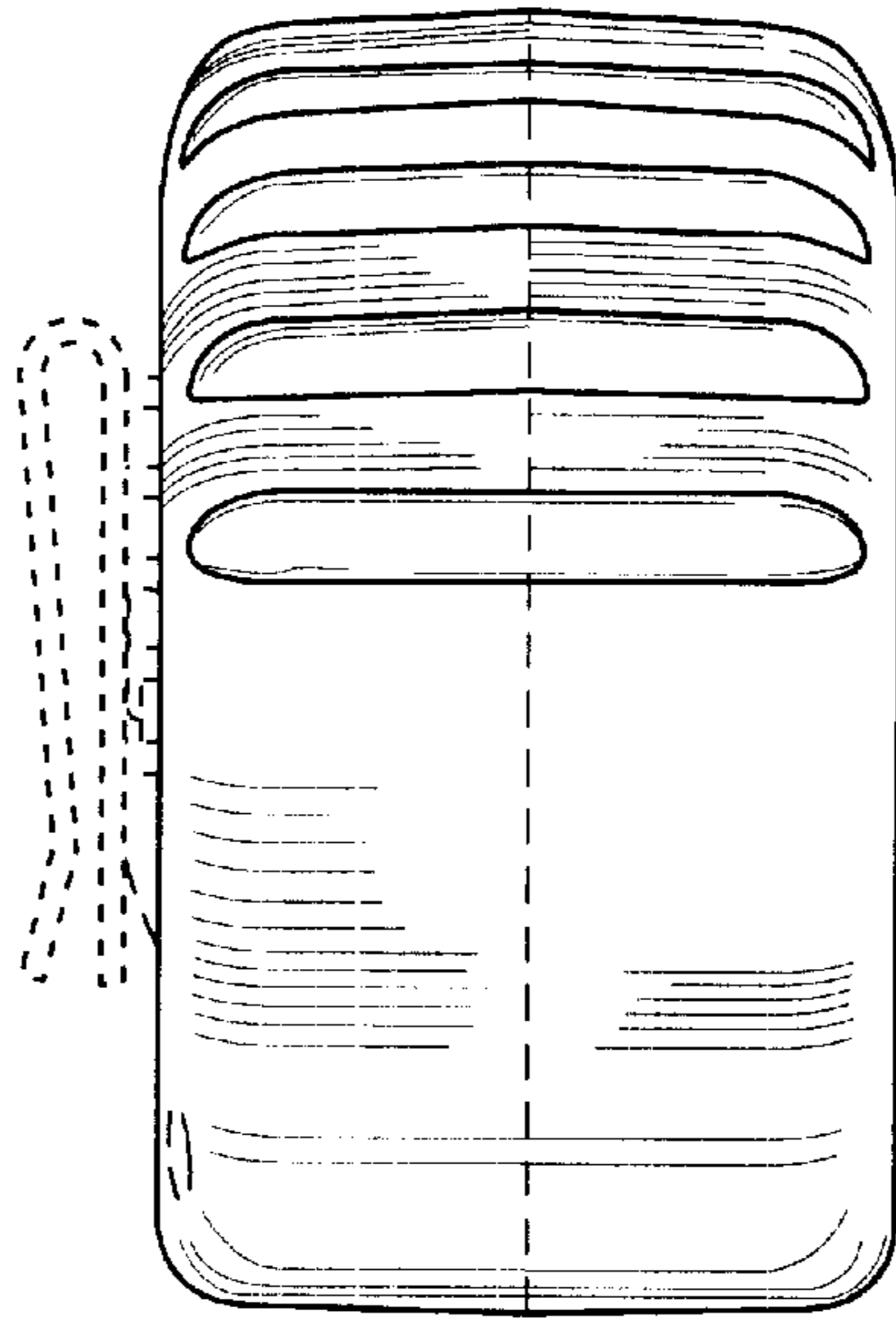

FIG. 4

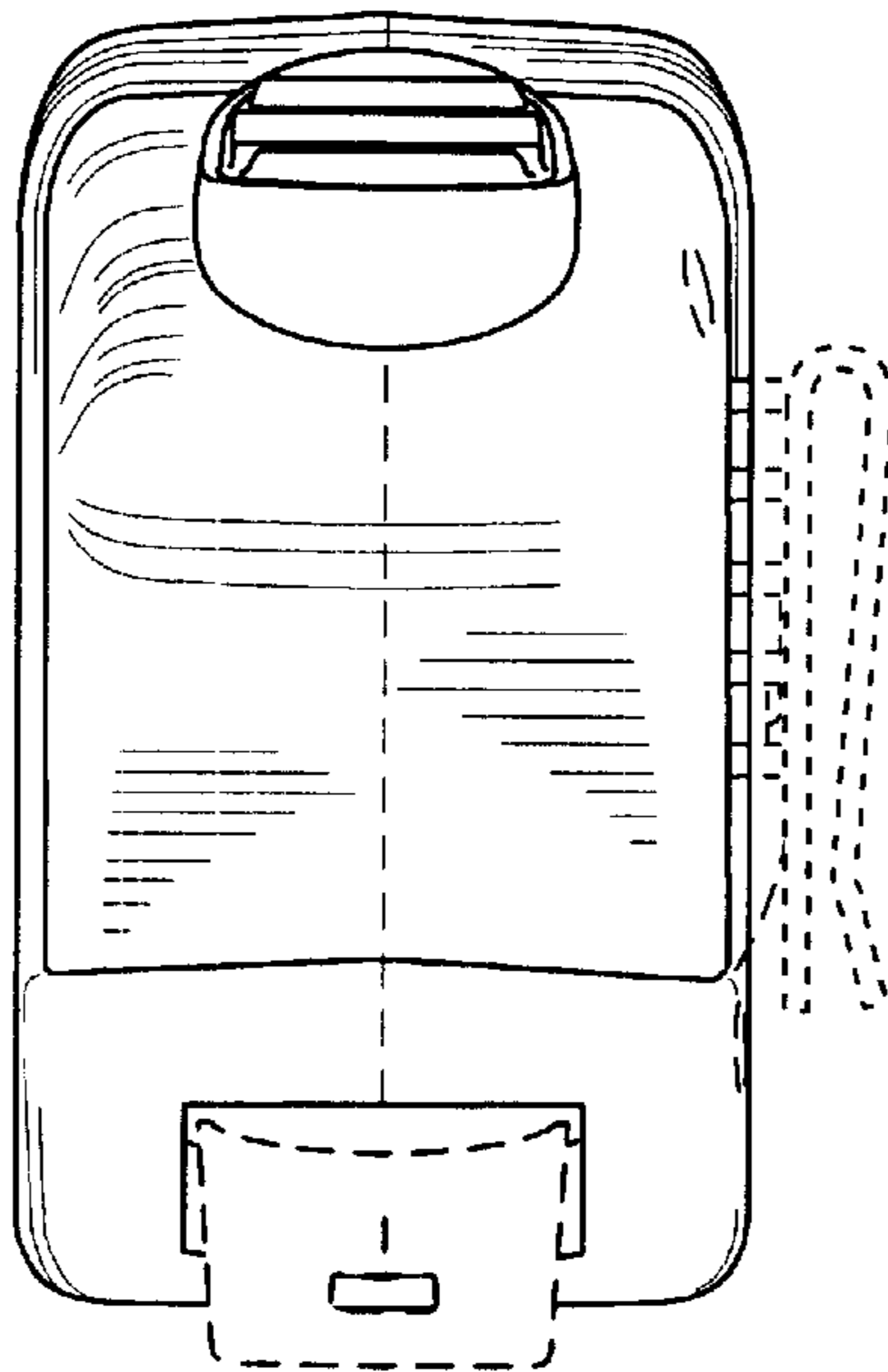

FIG. 5

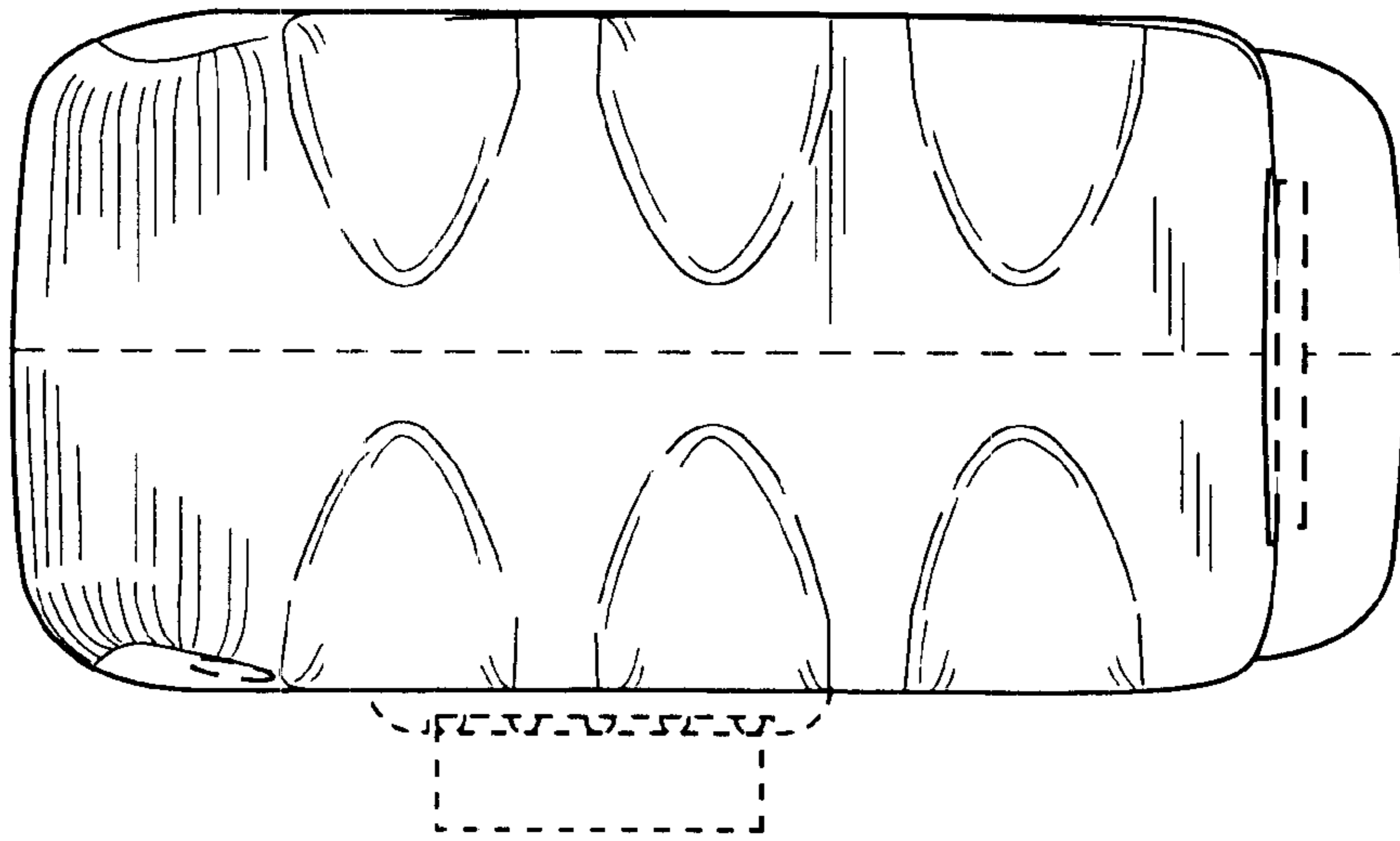

FIG. 6

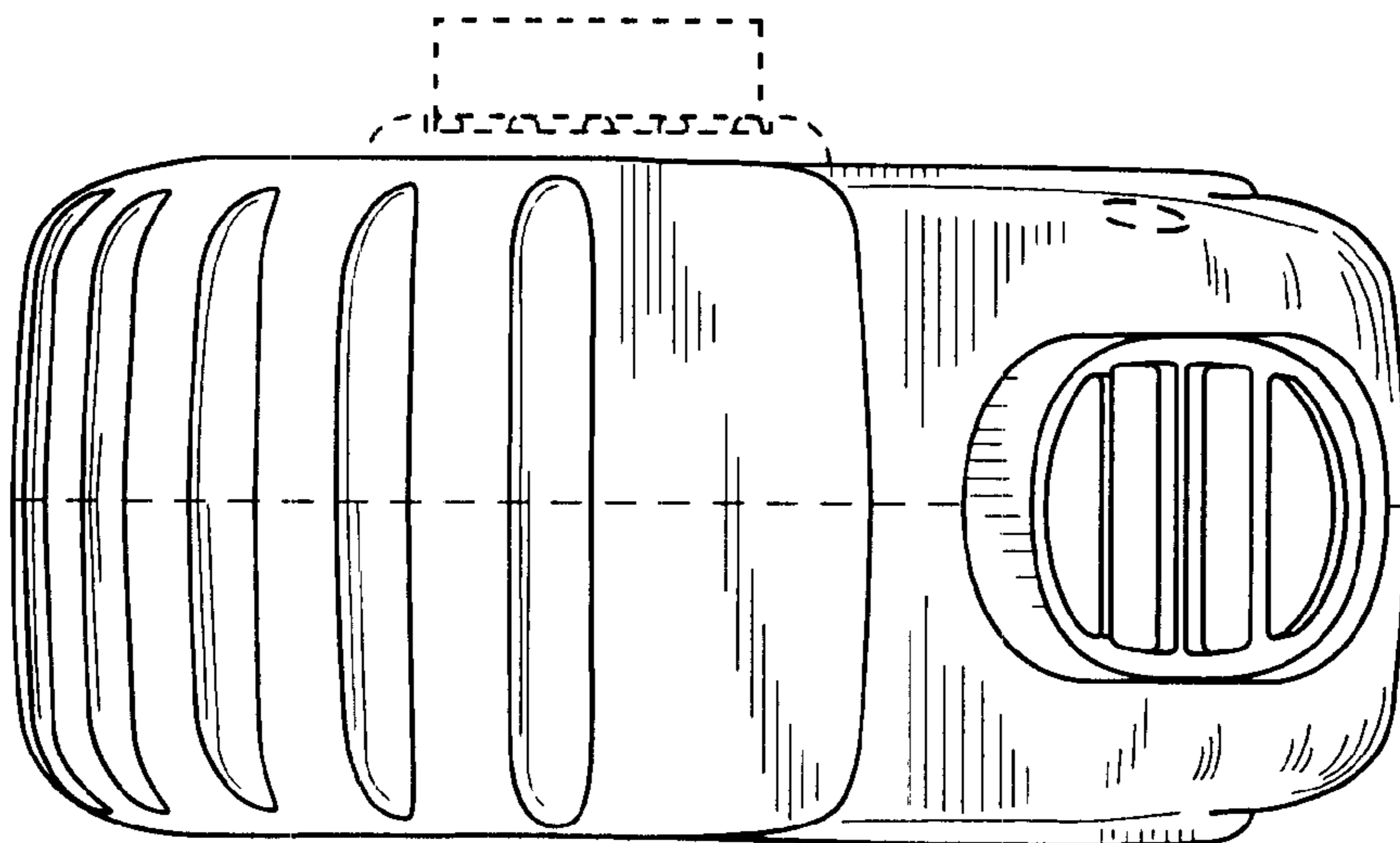

FIG. 7