



US00D476839S

(12) **United States Design Patent**  
**Hare**

(10) **Patent No.:** **US D476,839 S**

(45) **Date of Patent:** **\*\* Jul. 8, 2003**

(54) **DISPENSER**

D417,993 S \* 12/1999 Mahlmann ..... D6/542  
D426,093 S \* 6/2000 Cayouette ..... D6/542

(75) Inventor: **Danielle Hare**, Charlotte, NC (US)

\* cited by examiner

(73) Assignee: **Bath Unlimited, Inc.**, Fort Mill, SC (US)

*Primary Examiner*—Brian N. Vinson  
(74) *Attorney, Agent, or Firm*—Edgar A. Zarins; Lloyd D. Doigan

(\*\*) Term: **14 Years**

(57) **CLAIM**

(21) Appl. No.: **29/169,666**

The ornamental design for a dispenser, as shown and described.

(22) Filed: **Oct. 24, 2002**

(51) **LOC (7) Cl.** ..... **23-02**

**DESCRIPTION**

(52) **U.S. Cl.** ..... **D6/542**

FIG. 1 is a perspective view of a dispenser showing my new design;

(58) **Field of Search** ..... D6/542, 545; 206/77.1; 221/92, 96, 123, 208, 282, 284; 222/129, 135, 173; D9/537, 548, 549, 448

FIG. 2 is a front elevational view thereof;

FIG. 3 is a left side view thereof, the opposite side being a mirror image of the side shown;

FIG. 4 is a top plan view thereof;

FIG. 5 is a bottom plan view thereof; and,

FIG. 6 is a rear view thereof.

(56) **References Cited**

**U.S. PATENT DOCUMENTS**

D390,394 S \* 2/1998 Hsu ..... D6/542  
D416,154 S \* 11/1999 Diehl ..... D6/542

**1 Claim, 2 Drawing Sheets**

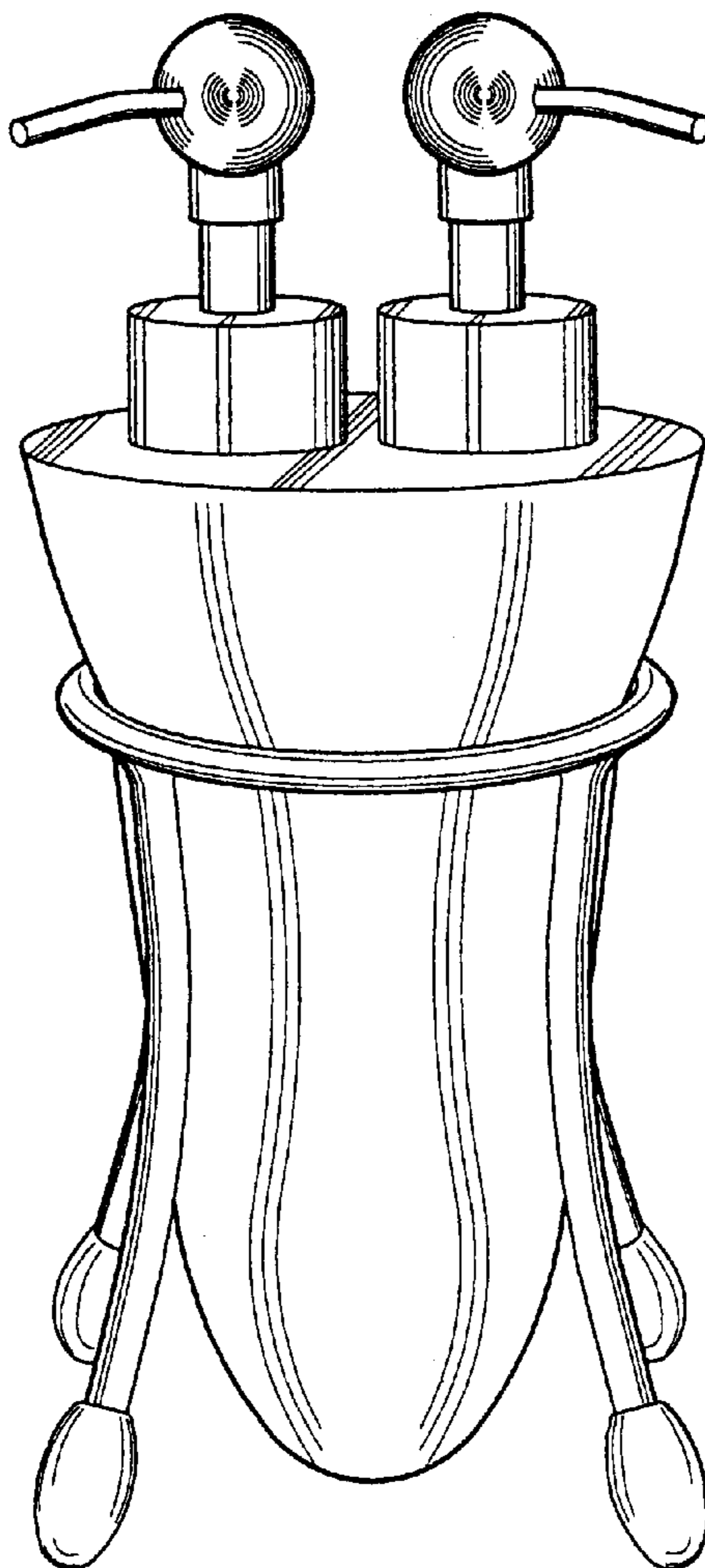

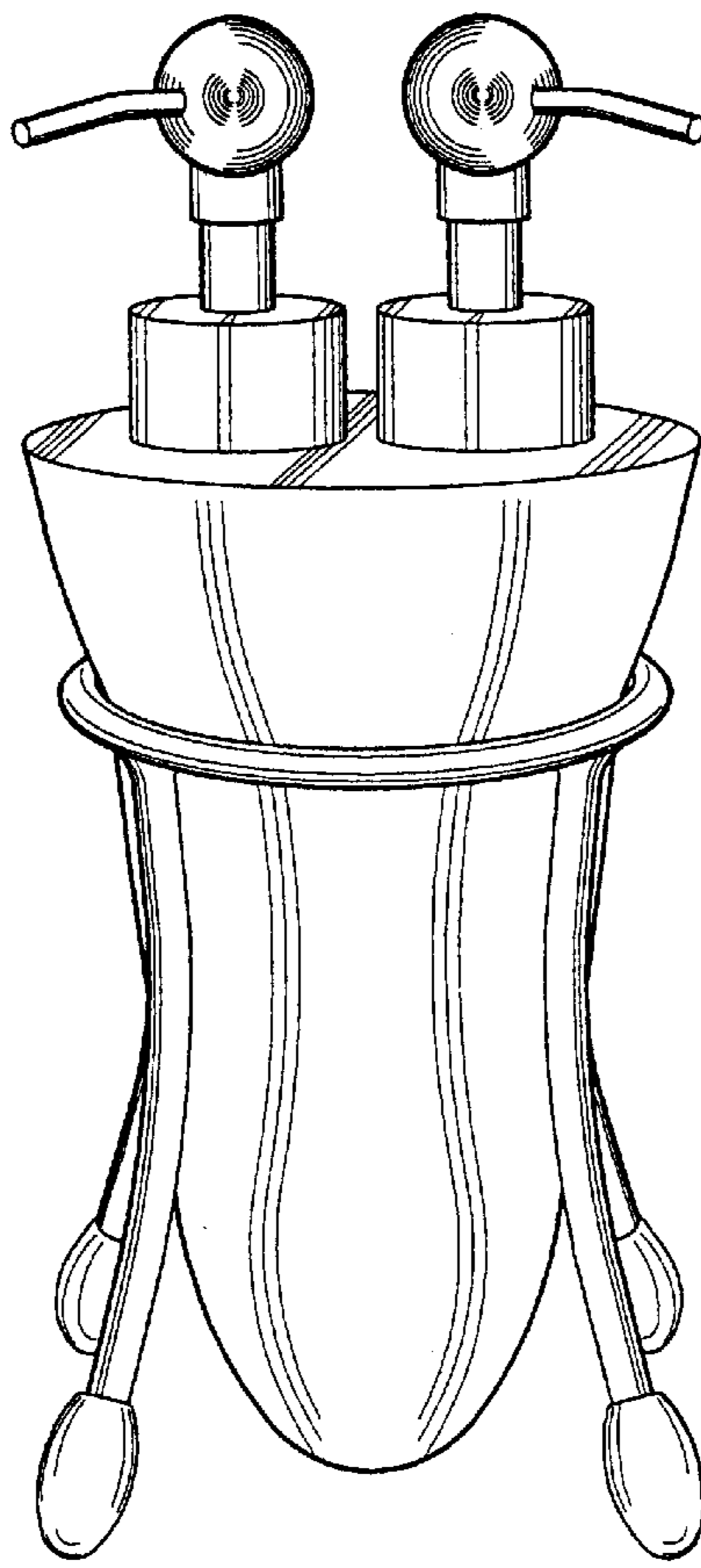

Fig-1

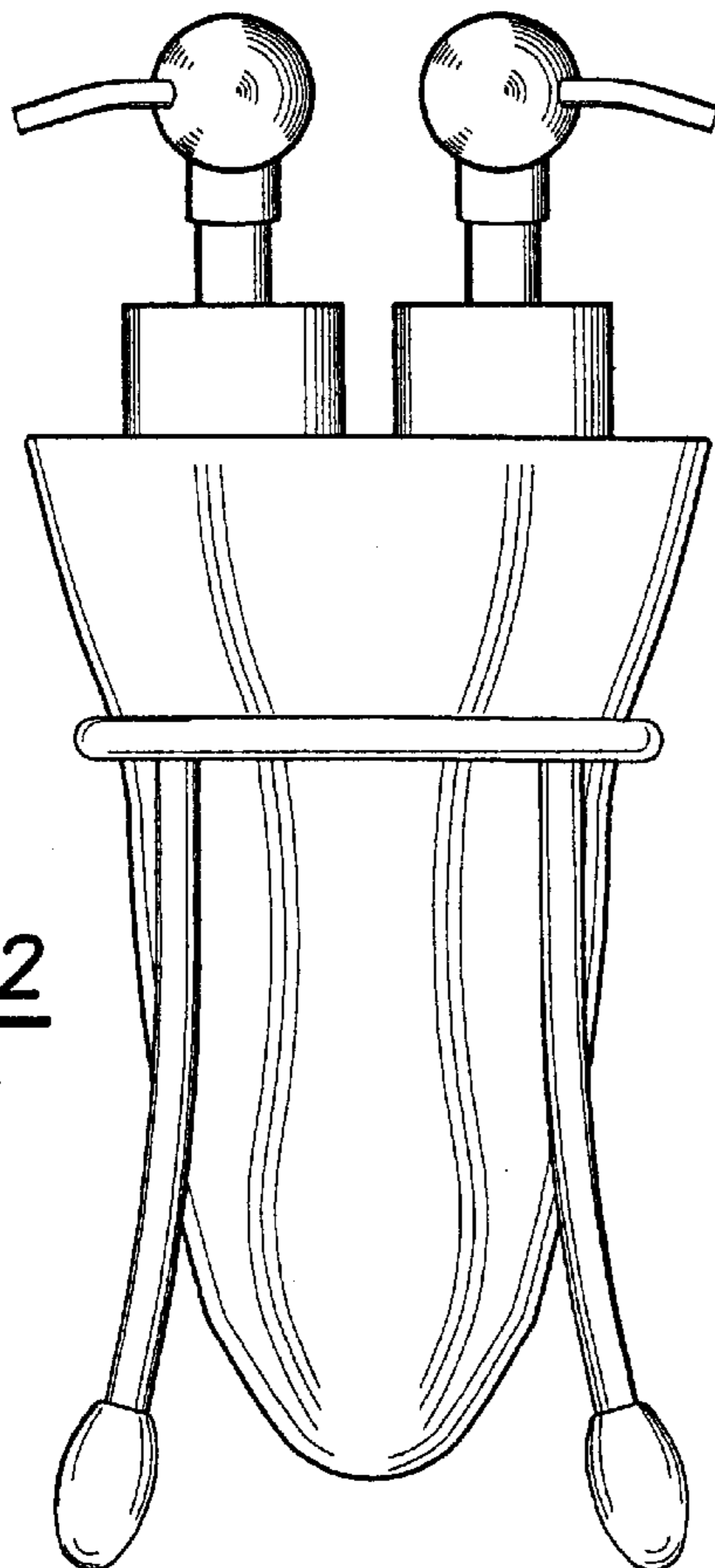

Fig-2

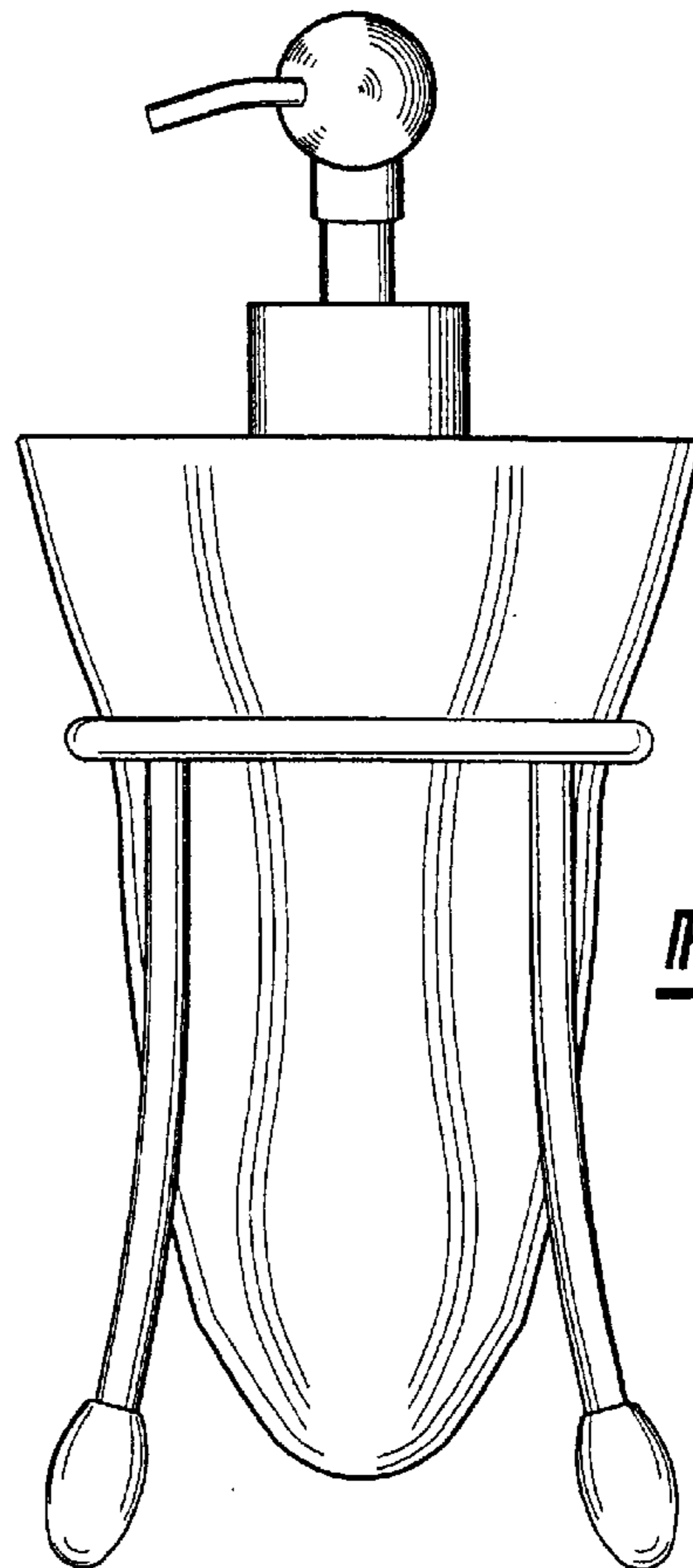

Fig-3

Fig-4

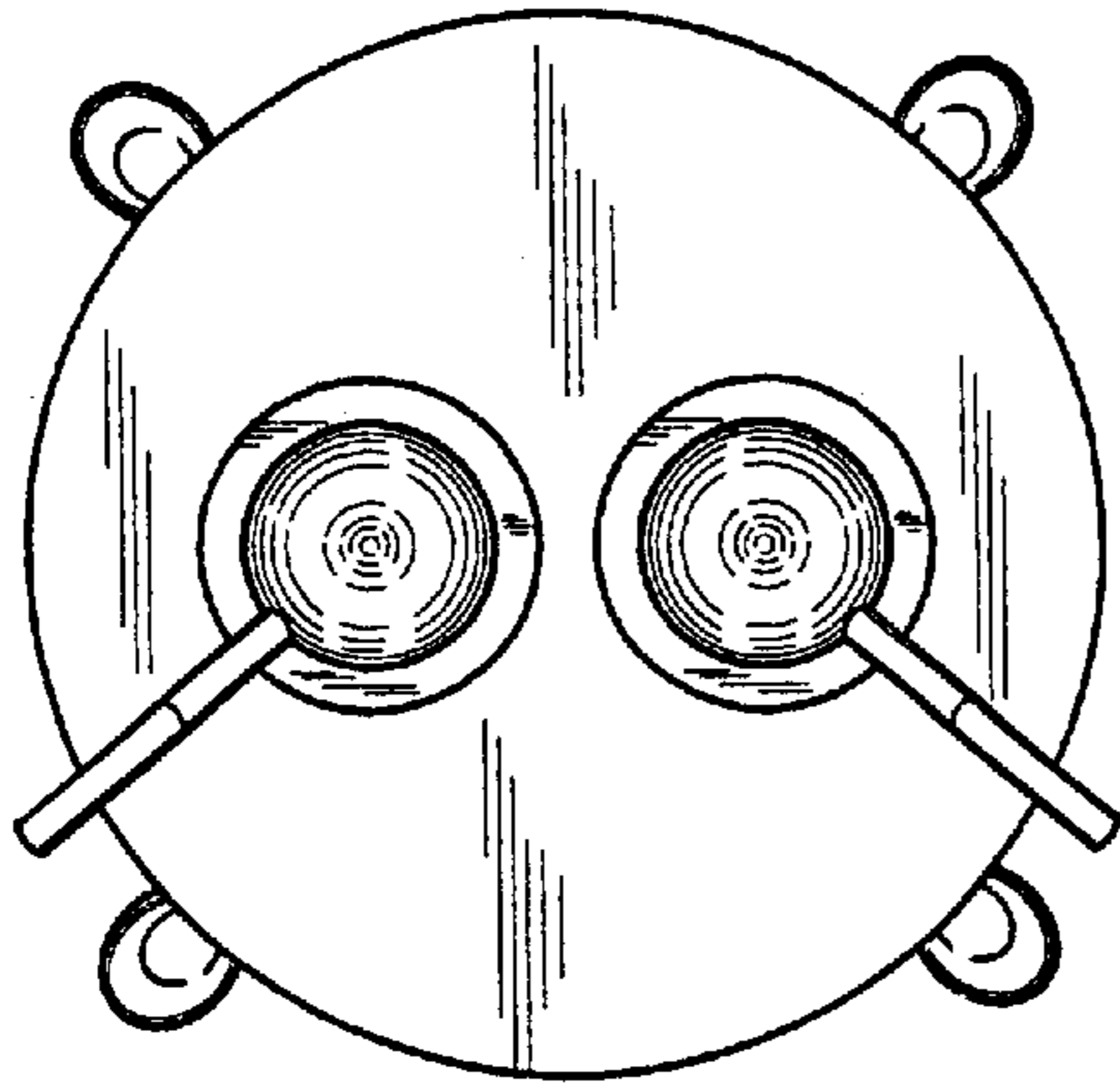

Fig-5

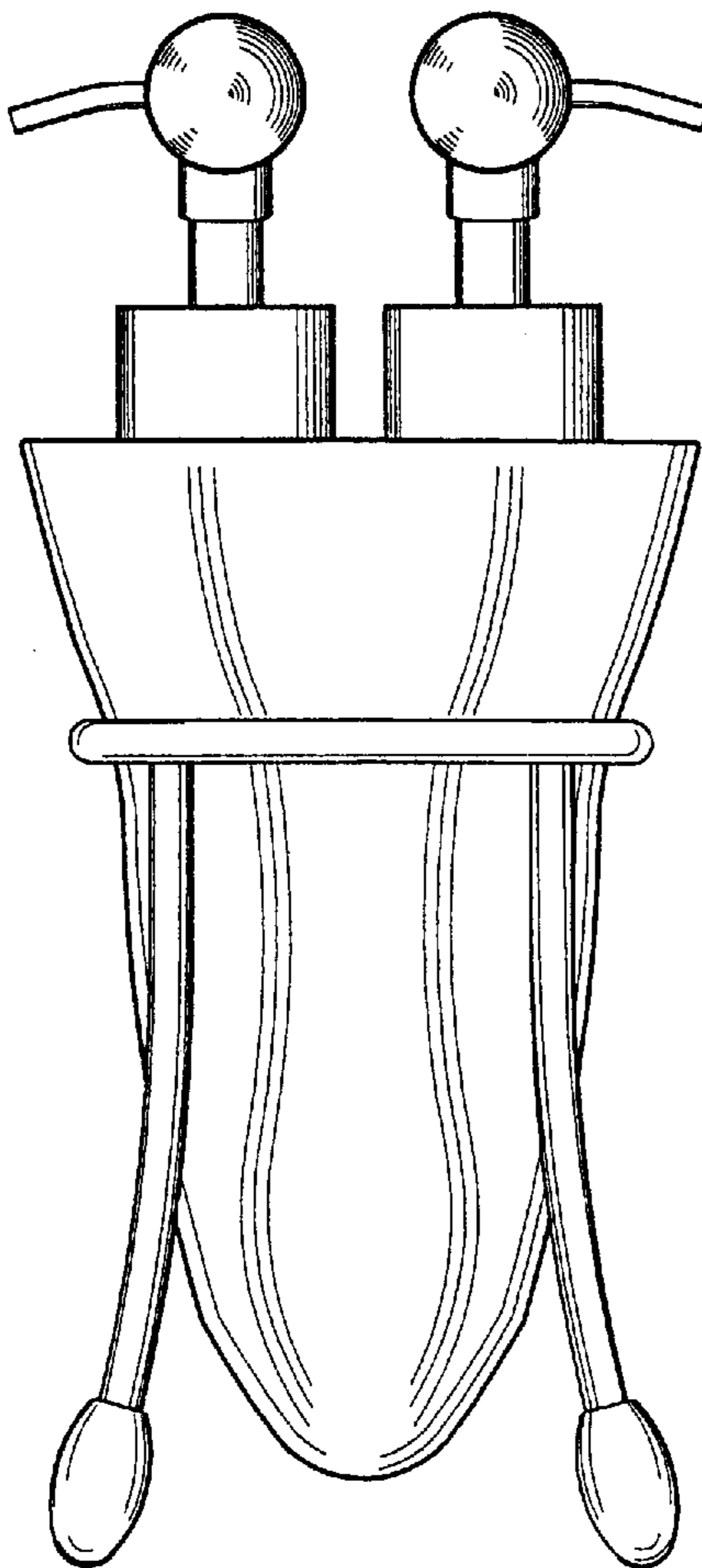
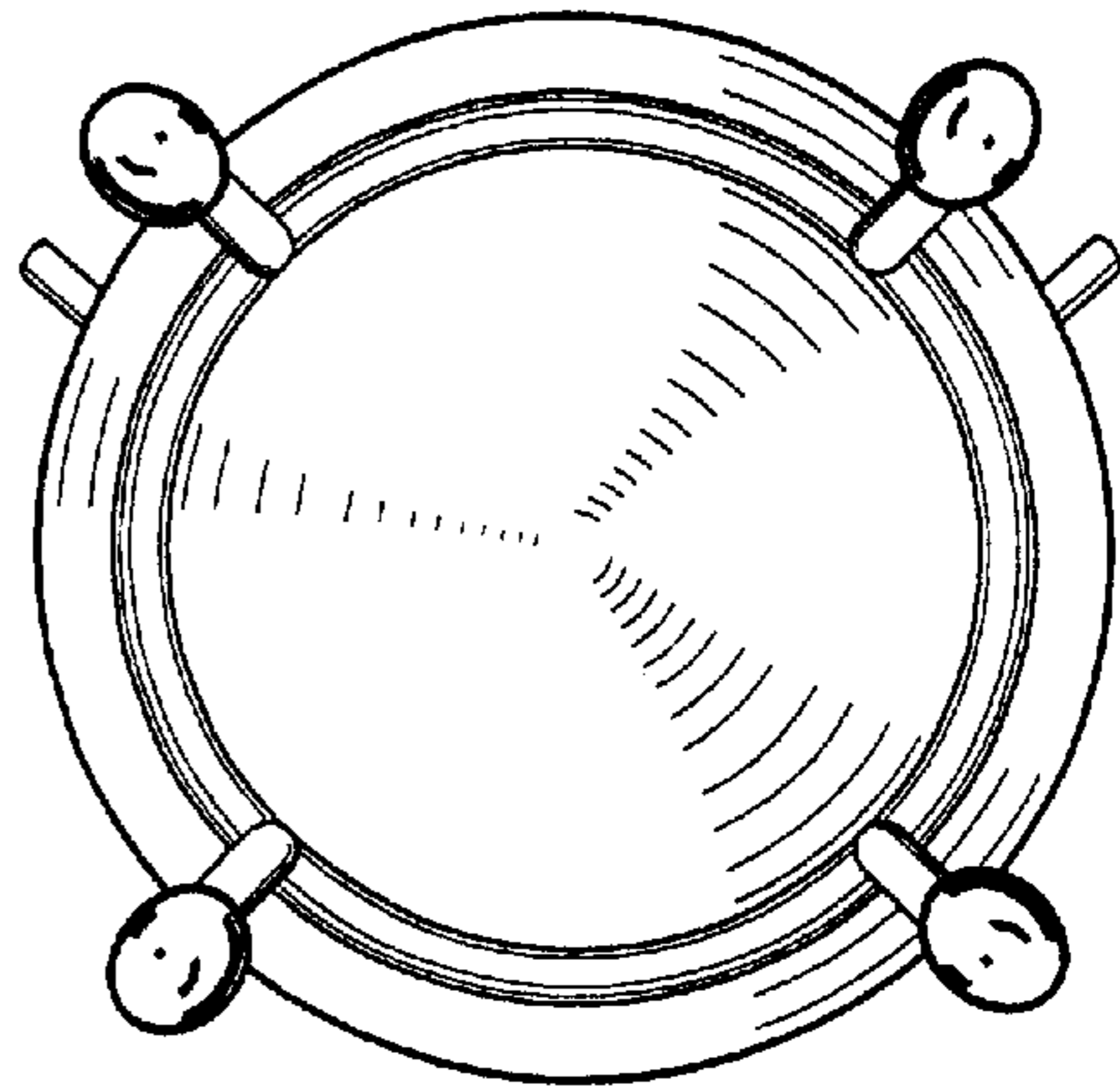

Fig-6