



US00D476772S

(12) **United States Design Patent**
Wonderley

(10) **Patent No.:** **US D476,772 S**

(45) **Date of Patent:** **** Jul. 1, 2003**

(54) **FINNED DISPOSABLE RAZOR WITH WINGS**

(75) **Inventor:** **Jeffrey W. Wonderley**, Fort Defiance, VA (US)

(73) **Assignee:** **American Safety Razor Company**, Verona, VA (US)

(**) **Term:** **14 Years**

(21) **Appl. No.:** **29/166,499**

(22) **Filed:** **Aug. 29, 2002**

(51) **LOC (7) Cl.** **28-03**

(52) **U.S. Cl.** **D28/48**

(58) **Field of Search** D28/45-48; D8/DIG. 7; 30/526, 527, 528, 51, 532, 85

(56) **References Cited**

U.S. PATENT DOCUMENTS

| | | | | | |
|------------|---|--------|-----------------|-------|--------|
| D218,001 S | * | 7/1970 | Goyke | | D28/48 |
| D389,955 S | * | 1/1998 | Wonderley | | D28/48 |
| D445,958 S | * | 7/2001 | Dansreau et al. | | D28/48 |
| D458,410 S | * | 6/2002 | Shepperson | | D28/48 |

* cited by examiner

Primary Examiner—Jennifer Rivard
(74) *Attorney, Agent, or Firm*—McDermott, Will & Emery

(57) **CLAIM**

The ornamental design for a finned disposable razor with wings, as shown and described.

DESCRIPTION

FIG. 1 is a front perspective view of the finned disposable razor with wings showing the new design;

FIG. 2 is a top view of the finned disposable razor with wings;

FIG. 3 is a bottom view of the finned disposable razor with wings;

FIG. 4 is a side view of the finned disposable razor with wings;

FIG. 5 is another side view of the finned disposable razor with wings;

FIG. 6 is a front view of the finned disposable razor with wings; and,

FIG. 7 is a back view of the finned disposable razor with wings.

1 Claim, 7 Drawing Sheets

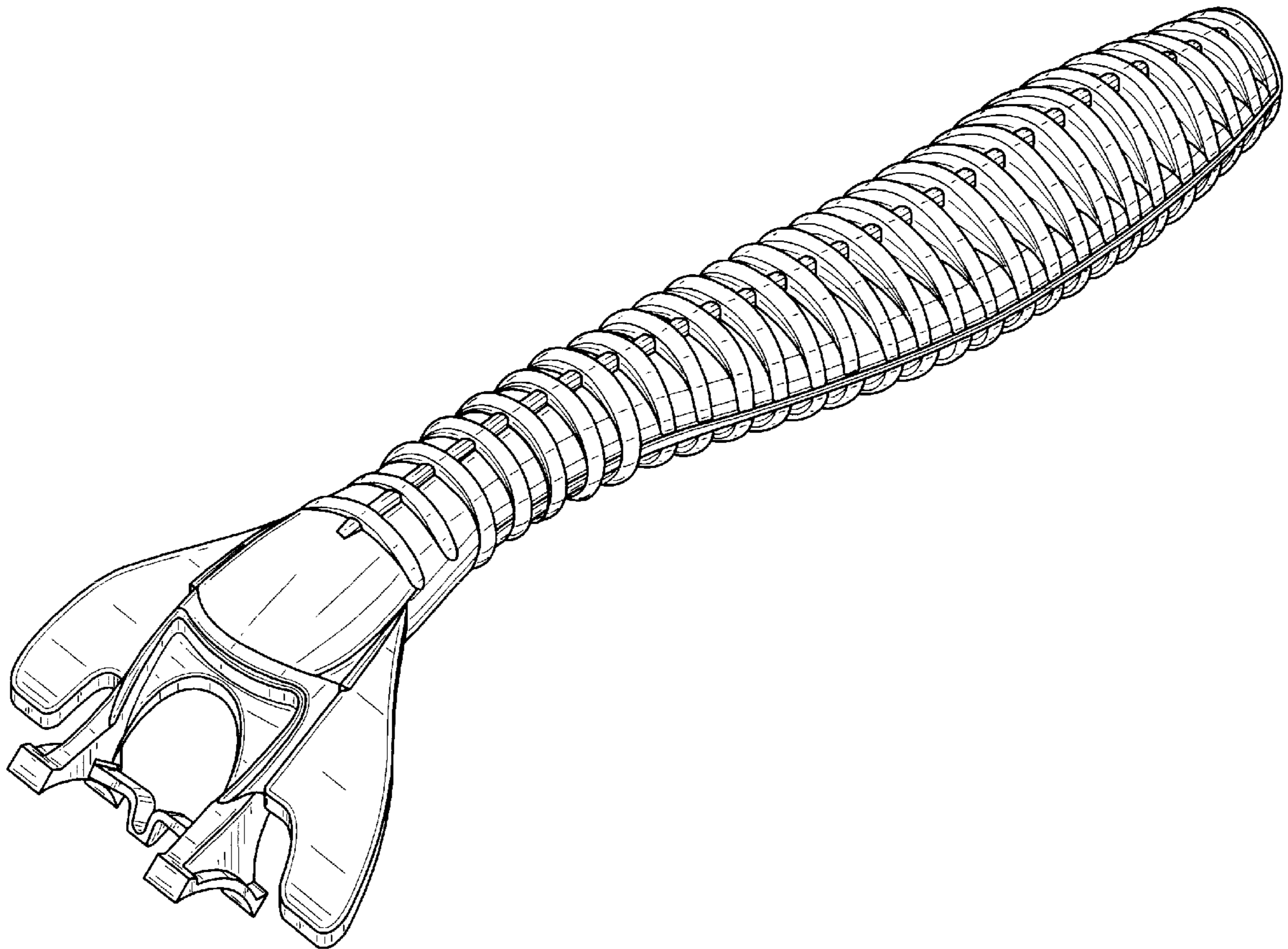

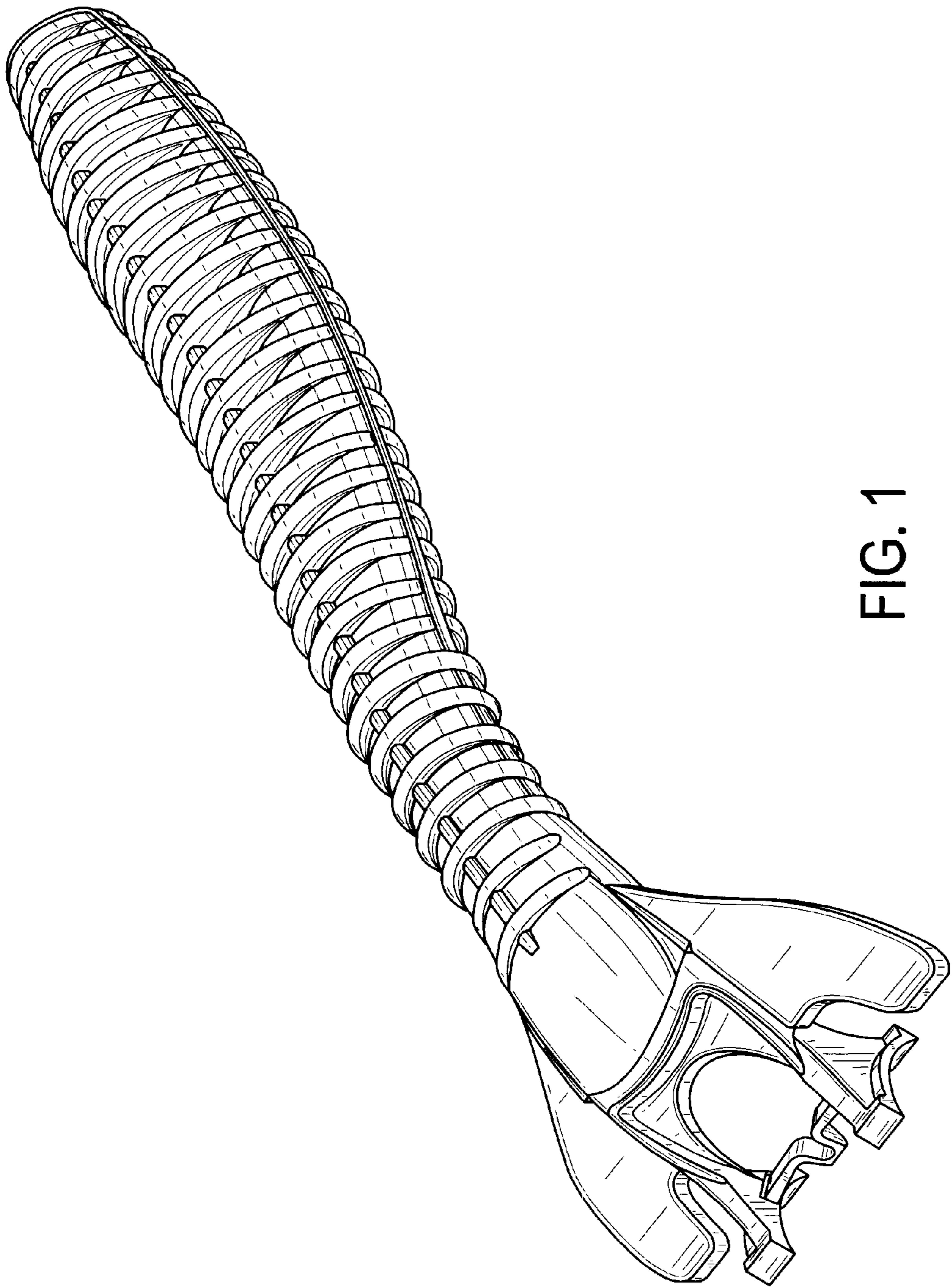

FIG. 1

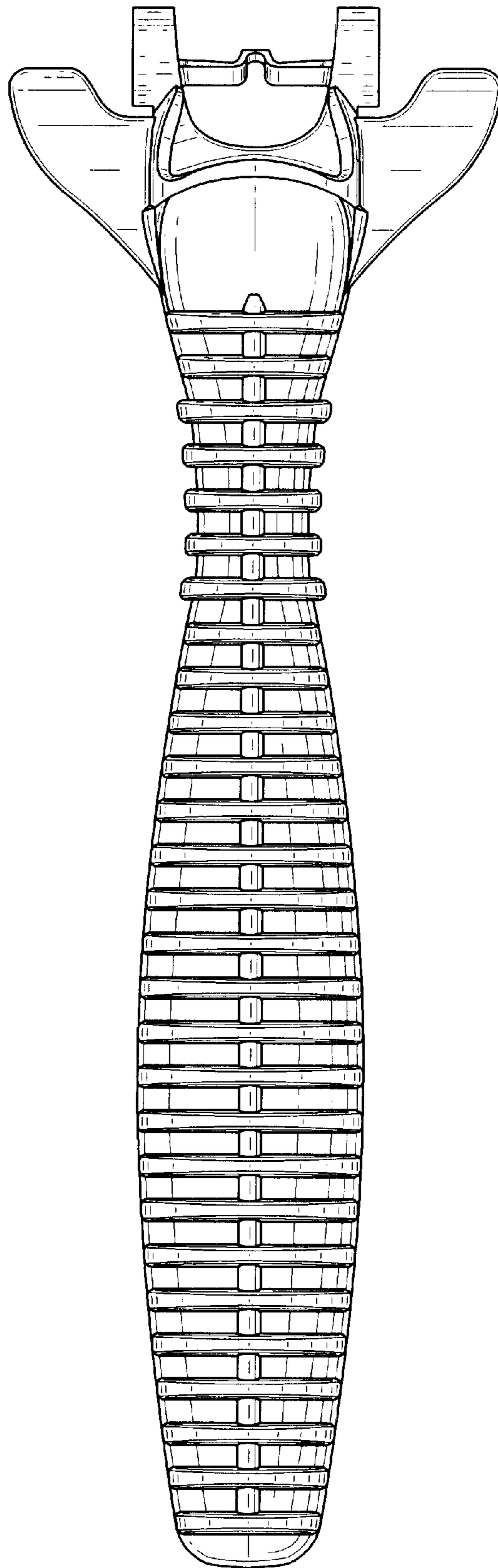

FIG. 2

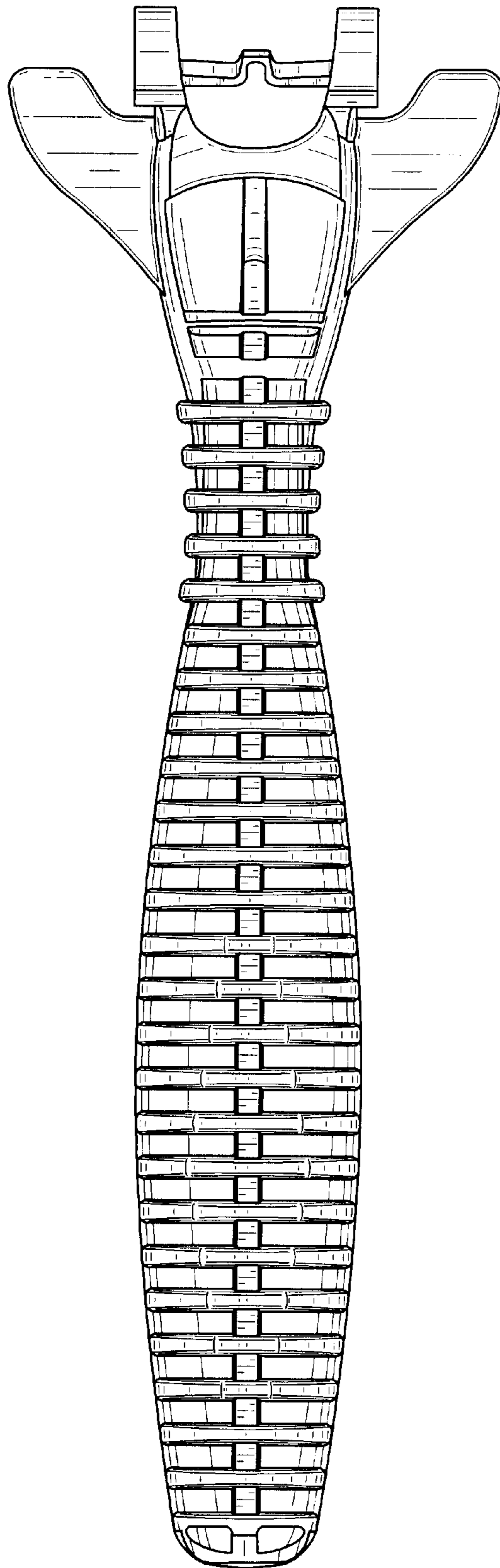

FIG. 3

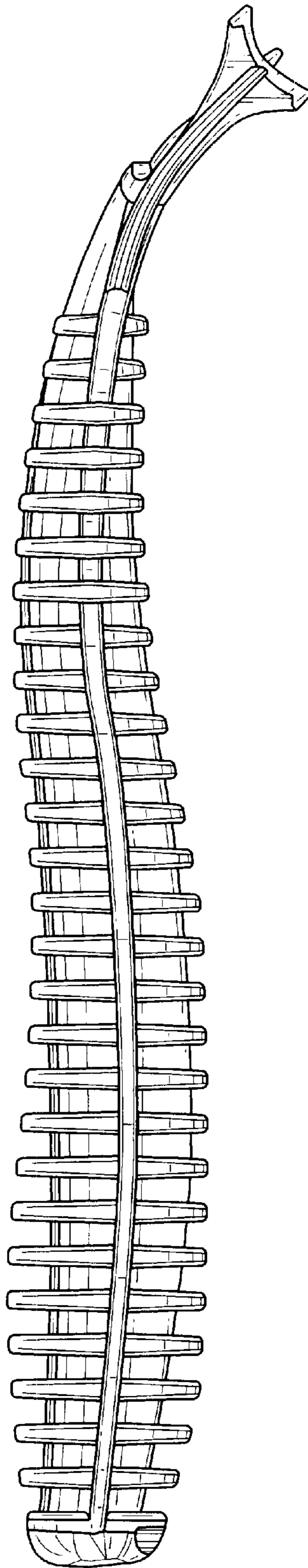

FIG. 4

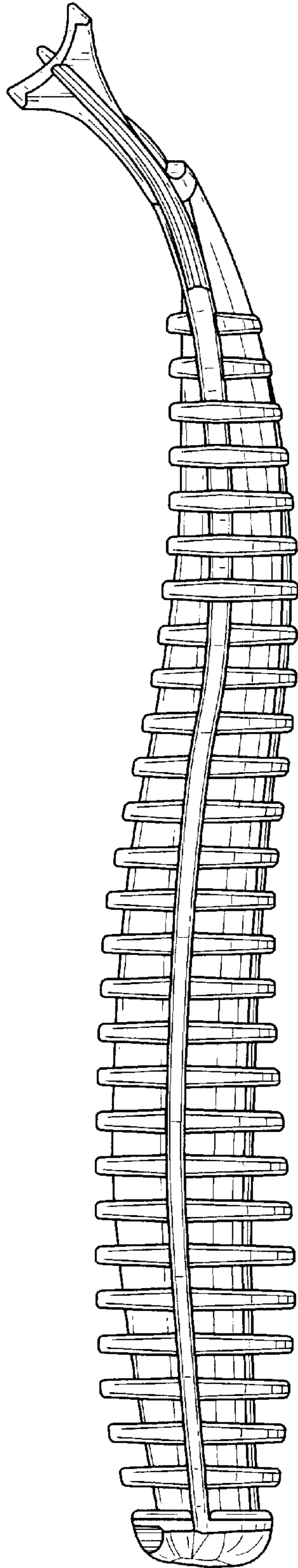

FIG. 5

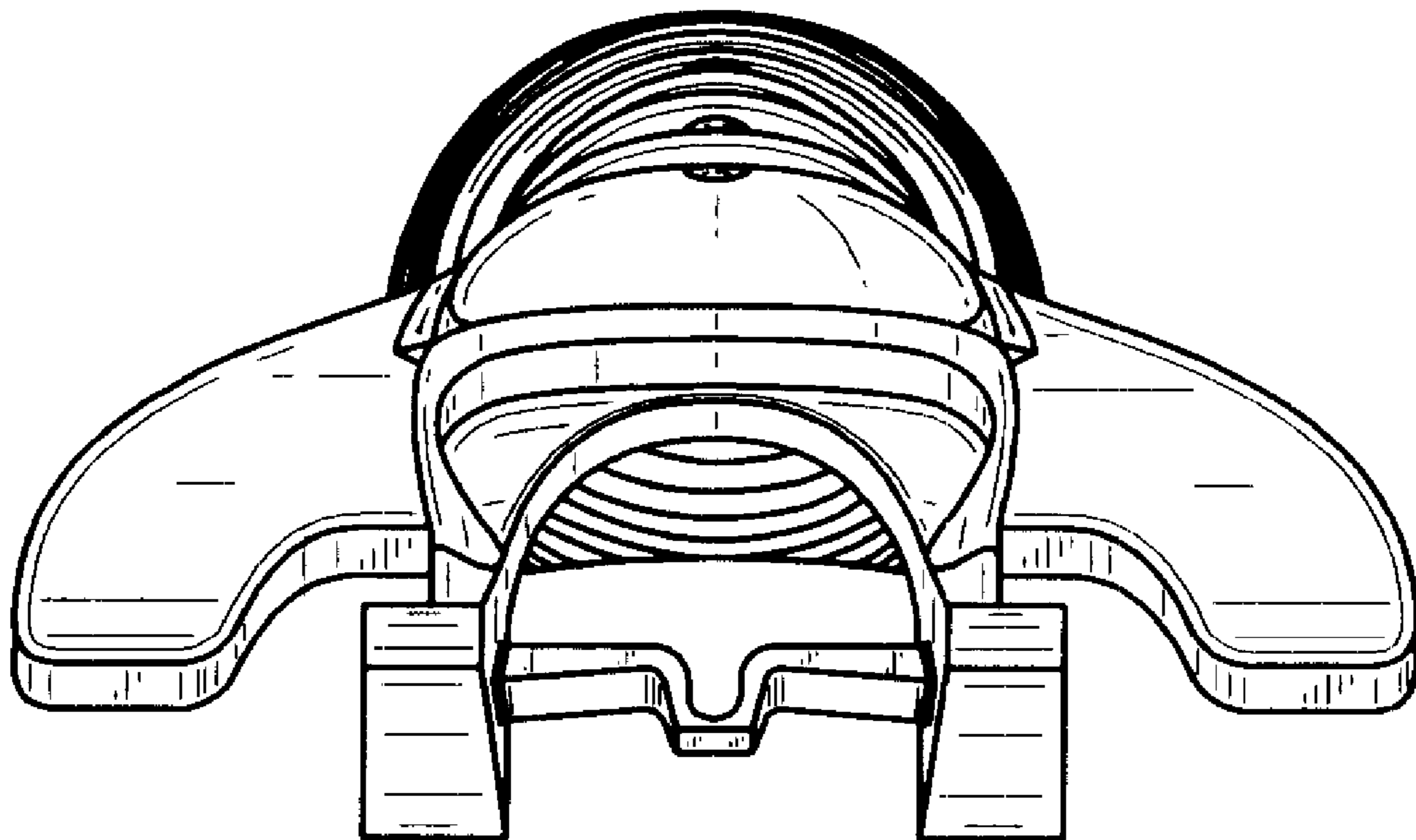

FIG. 6

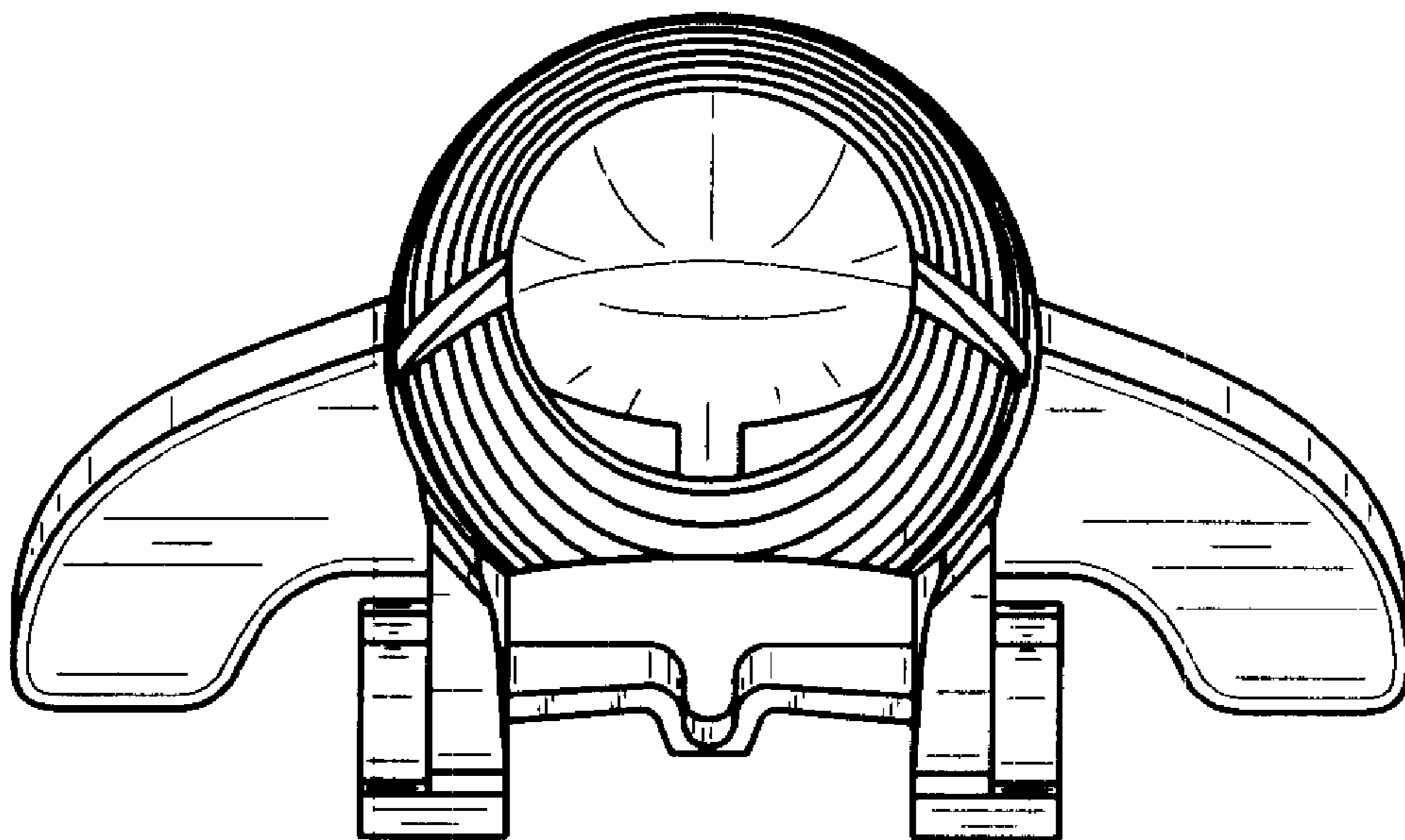

FIG. 7