



US00D476636S

(12) **United States Design Patent**
Ota

(10) **Patent No.:** **US D476,636 S**

(45) **Date of Patent:** **** Jul. 1, 2003**

(54) **DISC PLAYER**

D458,243 S 6/2002 Kobayashi

(75) Inventor: **Kiyoshi Ota**, Tokyo (JP)

OTHER PUBLICATIONS

(73) Assignee: **Sony Corporation**, Tokyo (JP)

Web page "SonyDrive," <http://www.sony.jp/products/Models/Library/D-VM1.html>, SONY (Apr. 2002).

(**) Term: **14 Years**

* cited by examiner

(21) Appl. No.: **29/164,417**

Primary Examiner—Nanda Bondade

(22) Filed: **Jul. 25, 2002**

(74) *Attorney, Agent, or Firm*—Rader, Fishman & Grauer PLLC

(51) **LOC (7) Cl.** **14-01**

(57) **CLAIM**

(52) **U.S. Cl.** **D14/156**

The ornamental design for a disc player, as shown.

(58) **Field of Search** D14/135-136,
D14/156-157, 160-165, 167-168, 188,
193-198; 369/75.1, 75.2, 77.1, 77.2; 455/344,
347-351

DESCRIPTION

(56) **References Cited**

U.S. PATENT DOCUMENTS

D421,436 S	*	3/2000	Matsuoka	D14/156
D434,749 S	*	12/2000	Ito et al.	D14/168
D441,350 S		5/2001	Nakayama et al.		
D451,080 S		11/2001	Kataoka		
D455,142 S	*	4/2002	Saitoh	D14/168

FIG. 1 is a perspective view of a disc player showing my new design;
FIG. 2 is a front elevational view thereof;
FIG. 3 is a rear elevational view thereof;
FIG. 4 is a left side elevational view thereof;
FIG. 5 is a right side elevational view thereof;
FIG. 6 is a top plan view thereof; and,
FIG. 7 is a bottom plan view thereof.

1 Claim, 4 Drawing Sheets

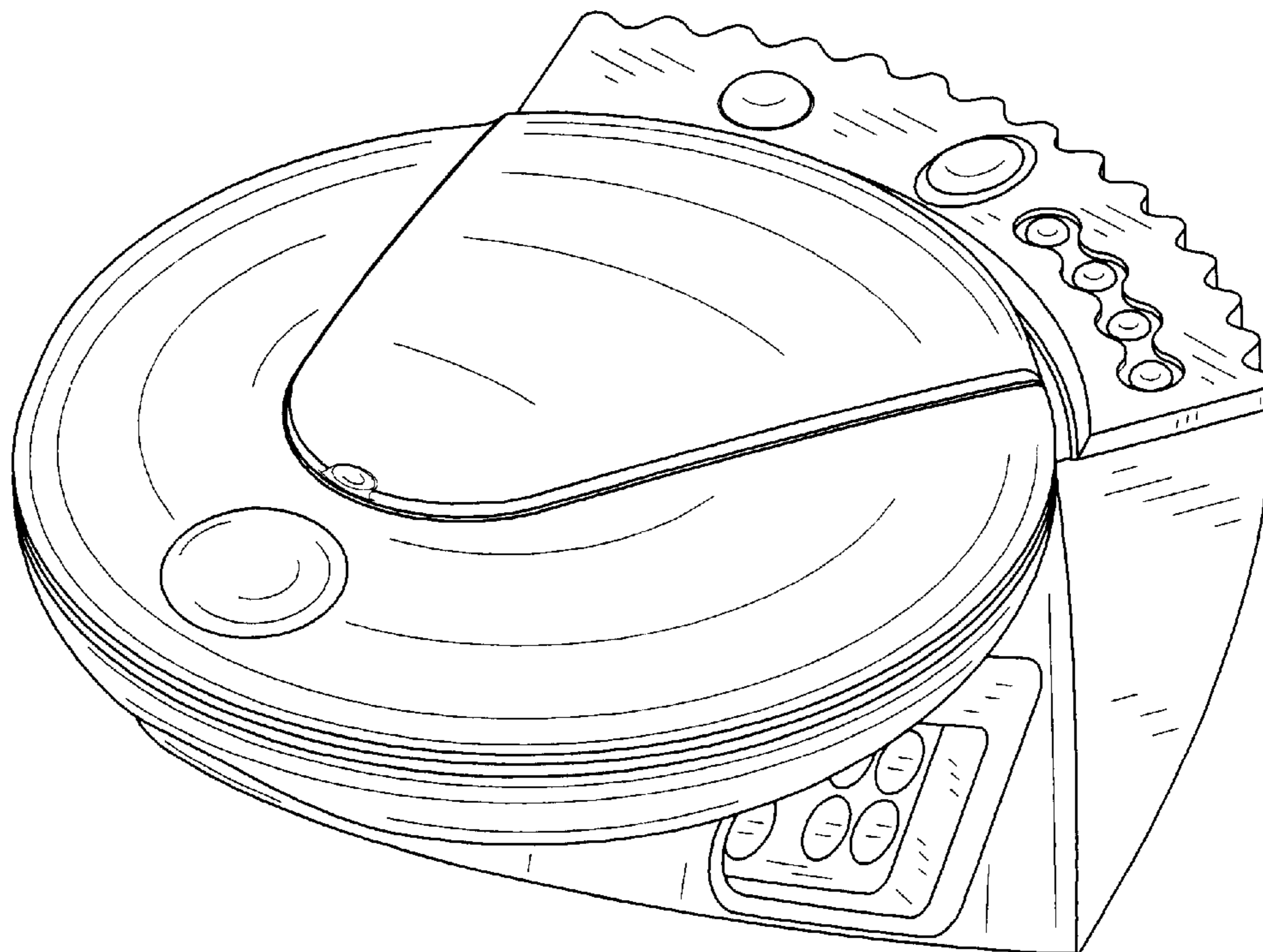

FIG. 1

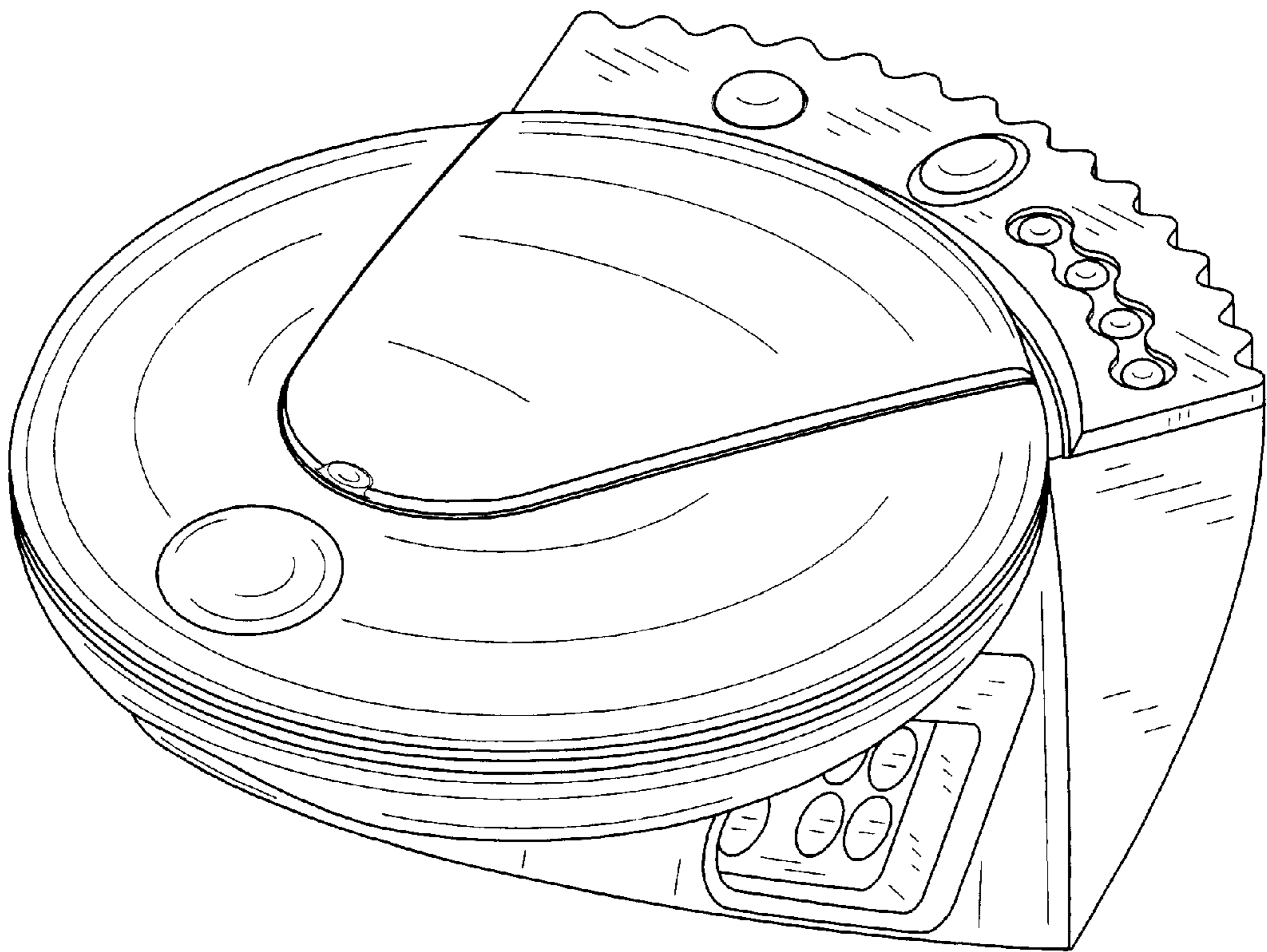

FIG. 2

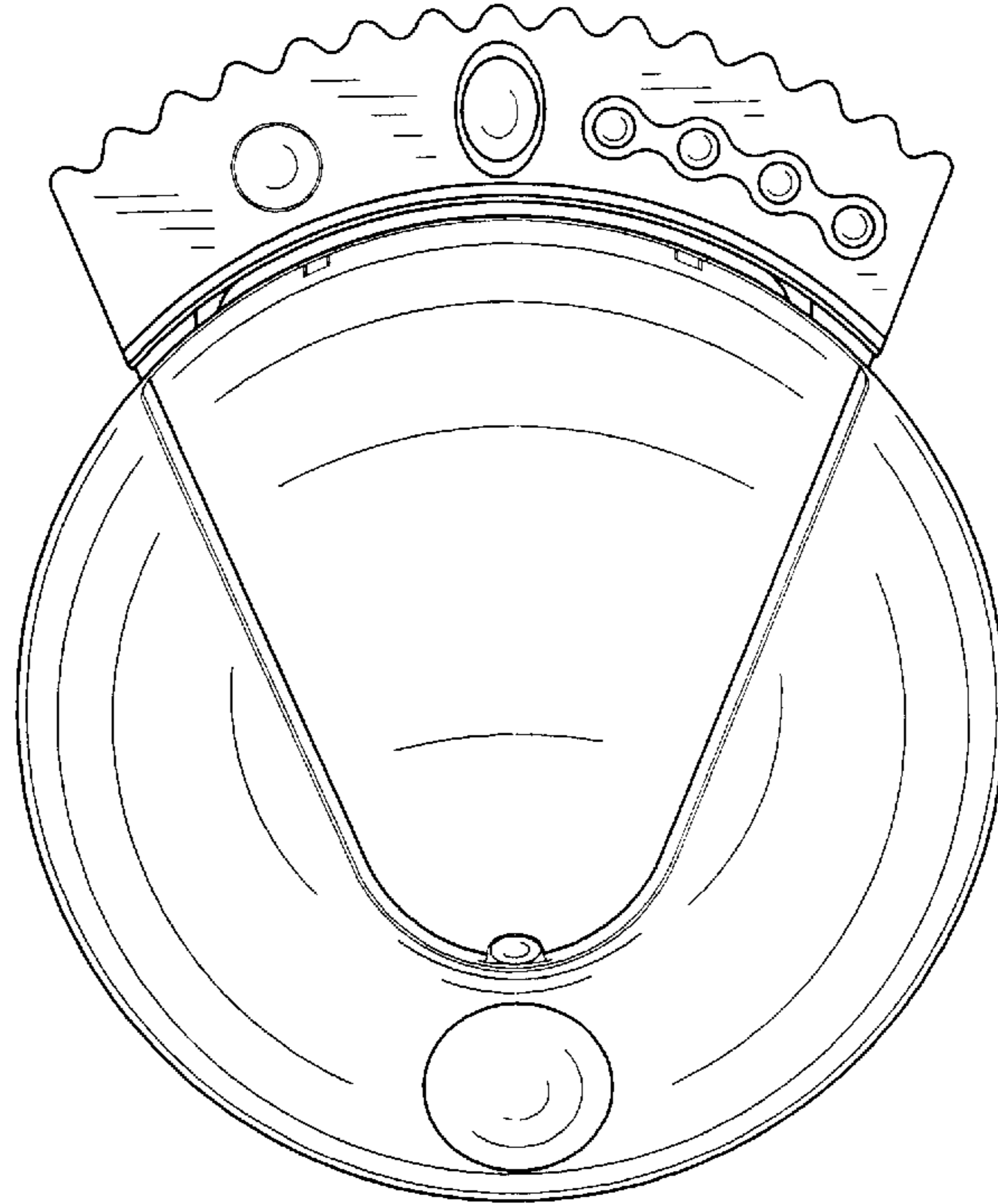

FIG. 3

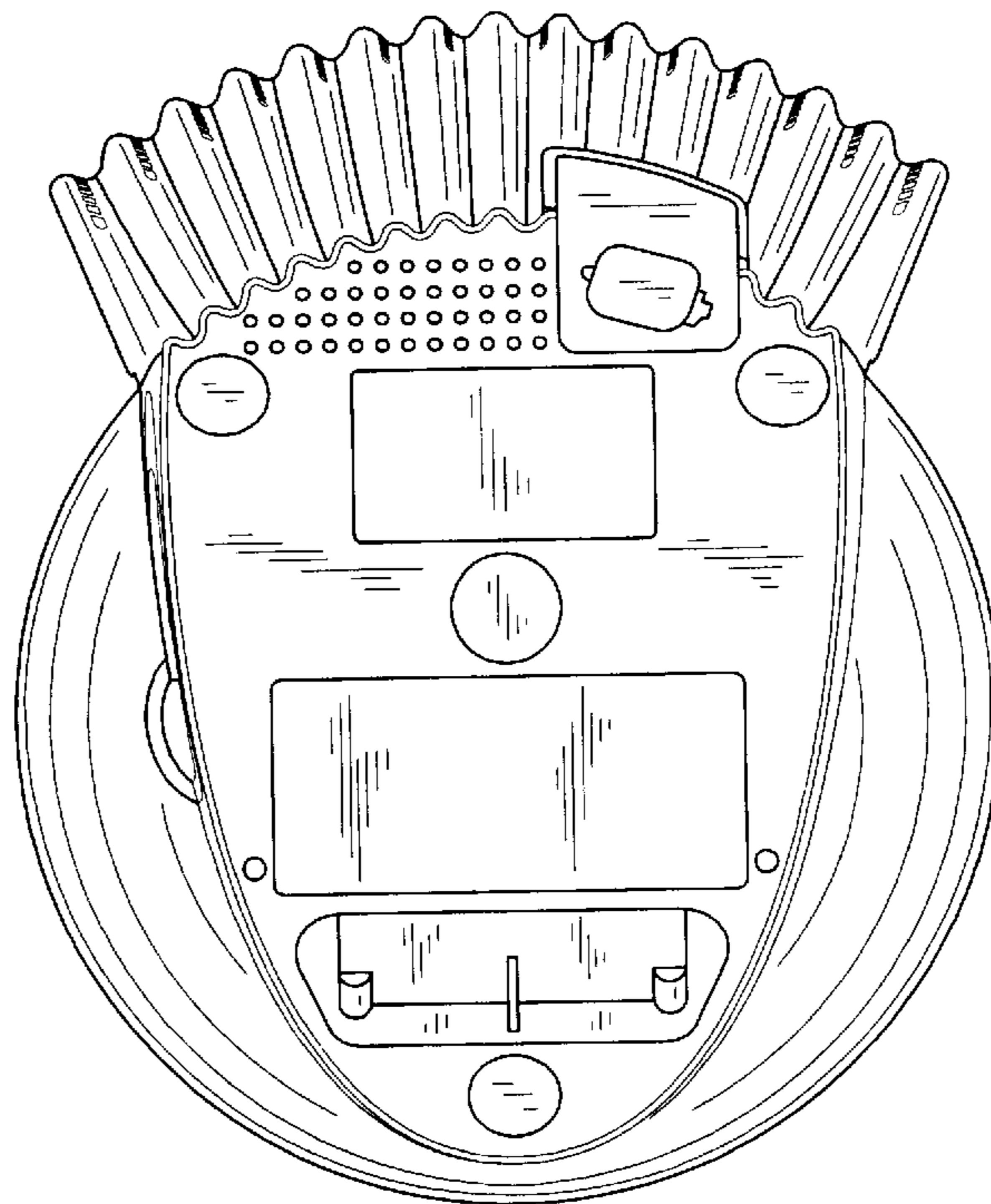

FIG. 4

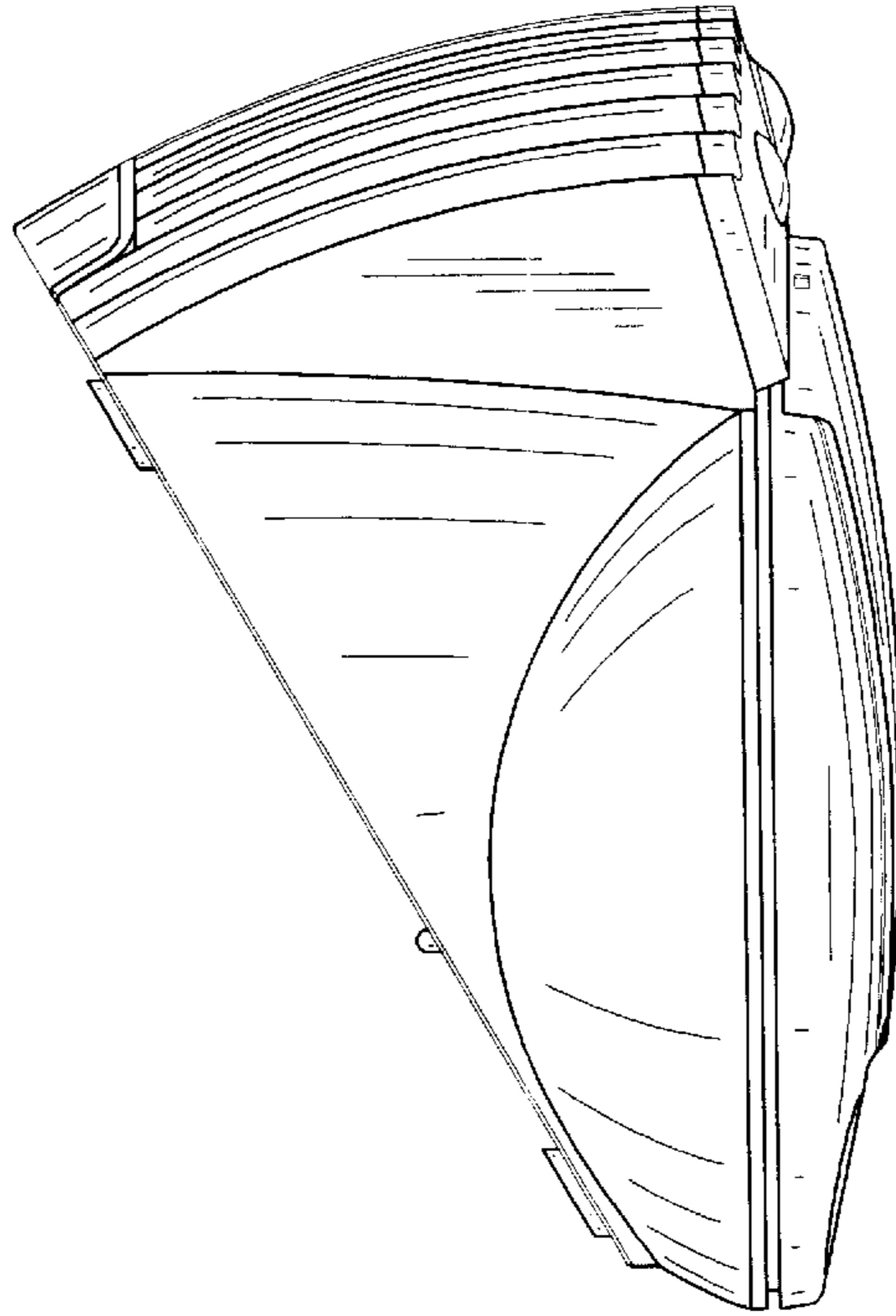

FIG. 5

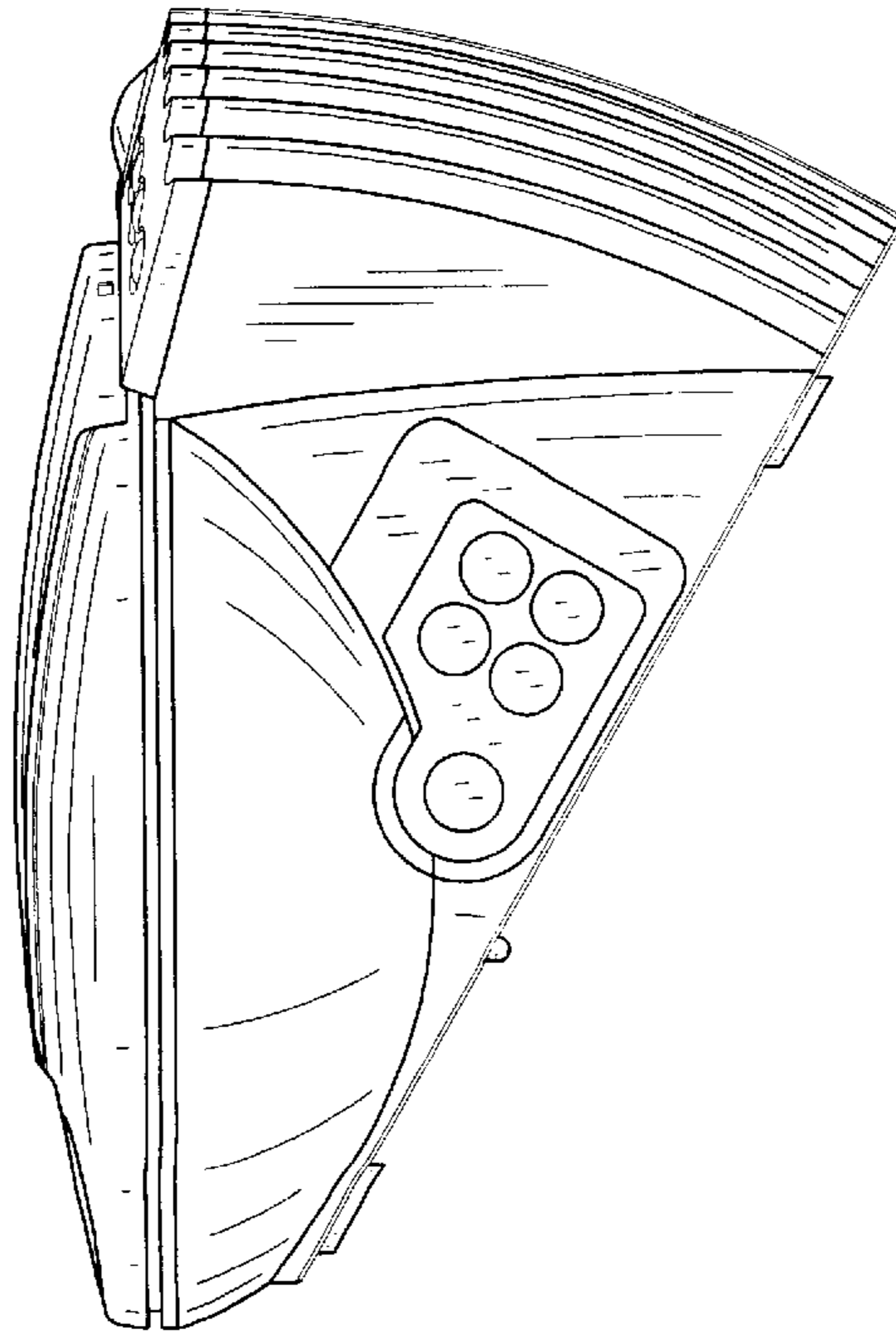

FIG. 6

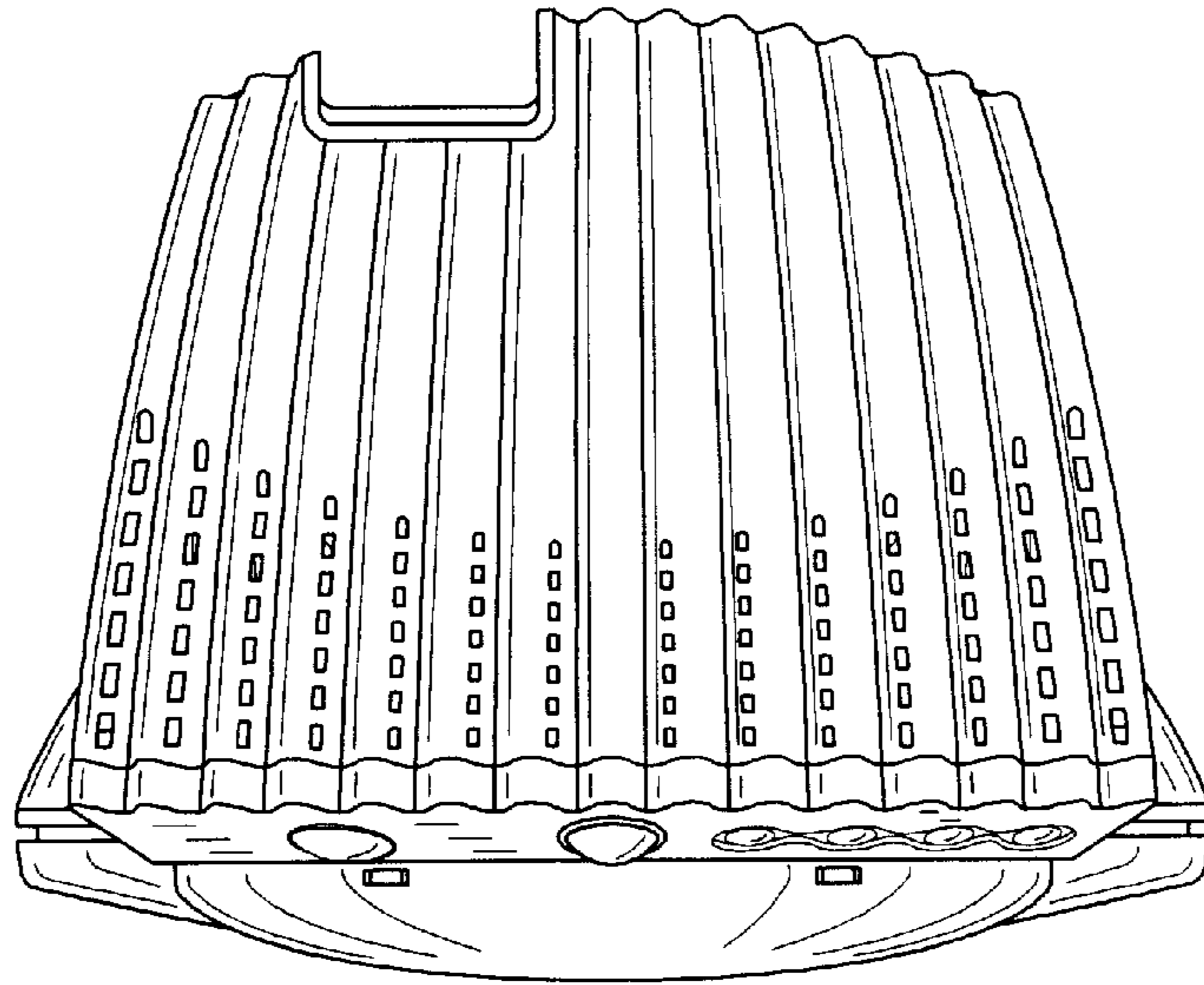

FIG. 7

