



US00D476601S

(12) **United States Design Patent**
Stoddard et al.

(10) **Patent No.: US D476,601 S**

(45) **Date of Patent: ** Jul. 1, 2003**

(54) **AUTOMOBILE BODY**

(75) Inventors: **Eric Stoddard**, Rochester Hills, MI (US); **Andrew P. Dyson**, West Bloomfield, MI (US); **David C. McKinnon**, Bloomfield, MI (US); **Joseph S. Dehner**, Bloomfield, MI (US)

(73) Assignee: **DaimlerChrysler Corporation**, Auburn Hills, MI (US)

(**) Term: **14 Years**

(21) Appl. No.: **29/152,512**

(22) Filed: **Dec. 19, 2001**

(51) **LOC (7) Cl. 12-08**

(52) **U.S. Cl. D12/92**

(58) **Field of Search D12/90-92, 86; 296/185**

(56) **References Cited**

U.S. PATENT DOCUMENTS

D360,171 S	7/1995	Hubbach et al.	D12/91
D366,231 S	1/1996	Wagner et al.	D12/92
D367,442 S	2/1996	Hubbach	D12/91
D370,646 S	6/1996	Verduyn	D12/91
D396,663 S	8/1998	Trostle et al.	D12/92
D412,299 S	7/1999	Shikado	D12/92
D413,082 S	8/1999	Trostle et al.	D12/92
D413,837 S	9/1999	Carlson et al.	D12/92
D414,445 S	9/1999	Dehner et al.	D12/92
D419,486 S	1/2000	Crain et al.	D12/91

D434,699 S	12/2000	Pfeiffer	D12/92
D439,867 S	4/2001	Pfeiffer	D12/92
D440,528 S	4/2001	Irons	D12/92
D455,370 S	* 4/2002	Nesbitt et al.	D12/92
D455,676 S	* 4/2002	Stoddard et al.	D12/92

OTHER PUBLICATIONS

Co-pending U.S. patent application Ser. No. 29/134,134 entitled "Automobile Body" filed Dec. 14, 2000, Pat. No. D. 455,676 S1.

* cited by examiner

Primary Examiner—Melody N. Brown

(74) *Attorney, Agent, or Firm*—Ralph E. Smith

(57) **CLAIM**

The ornamental design for an automobile body, as shown and described.

DESCRIPTION

FIG. 1 is a right side view of an automobile body showing our new design.

FIG. 2 is a front view thereof.

FIG. 3 is a rear view thereof.

FIG. 4 is a left view thereof.

FIG. 5 is a front perspective view thereof; and,

FIG. 6 is a rear perspective view thereof.

It will be understood that the top is plain and unornamental and further that the hidden line shown throughout the drawings is for illustration only, forming no part of the claimed design.

1 Claim, 5 Drawing Sheets

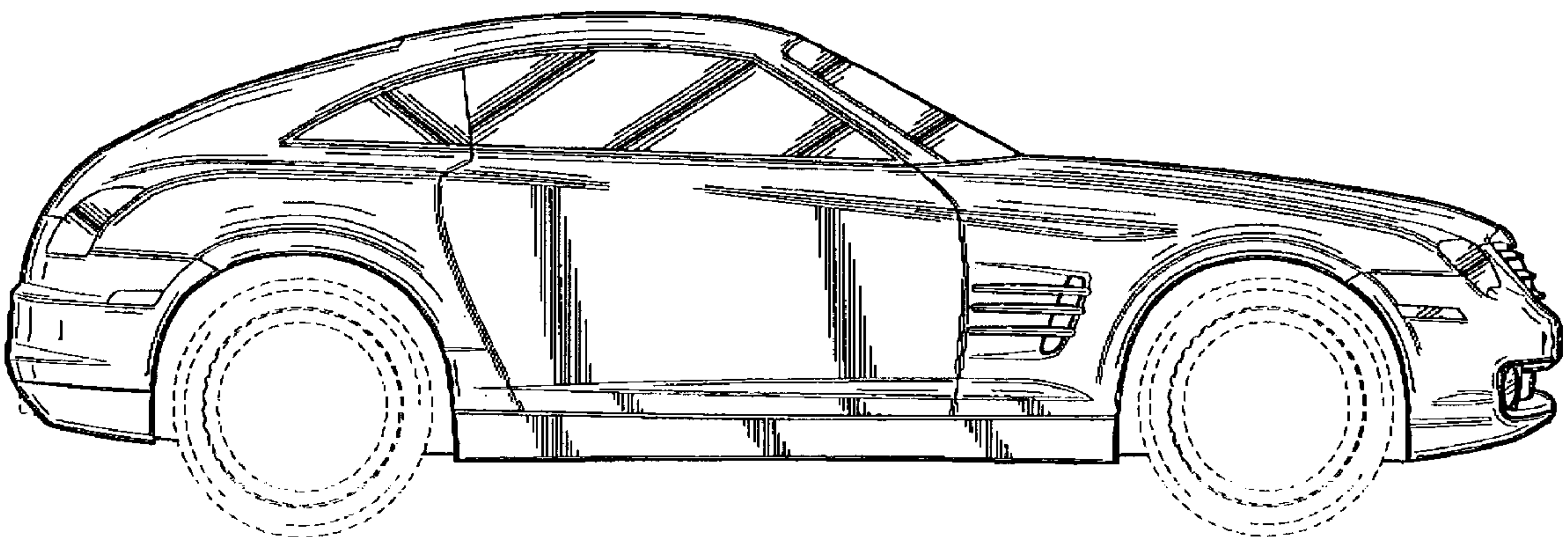

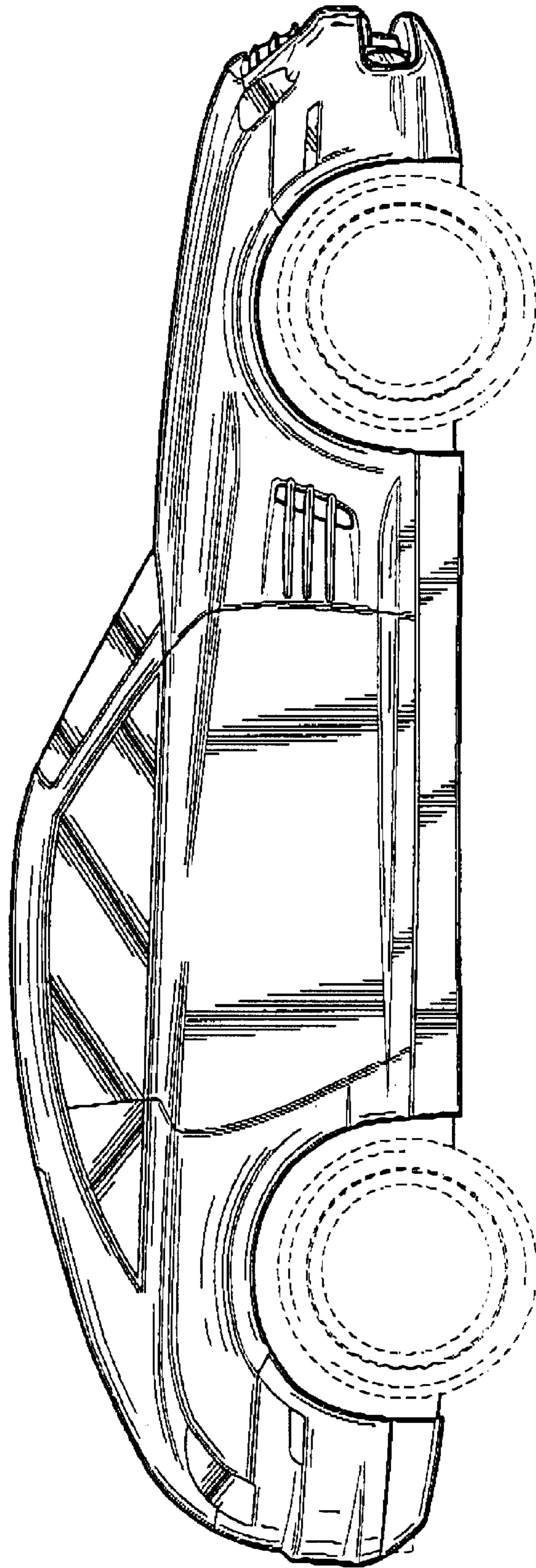

Figure - 1

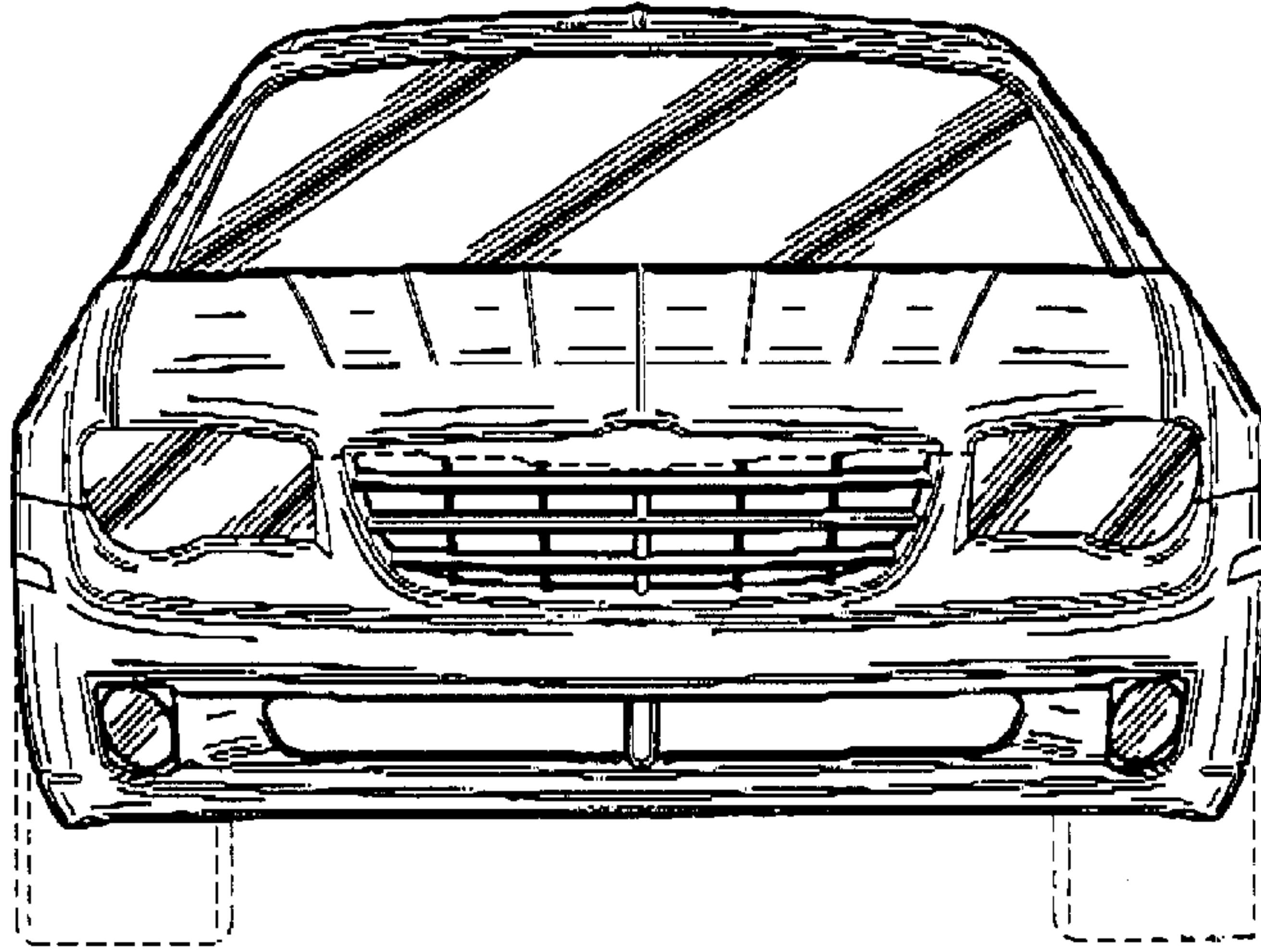

Figure - 2

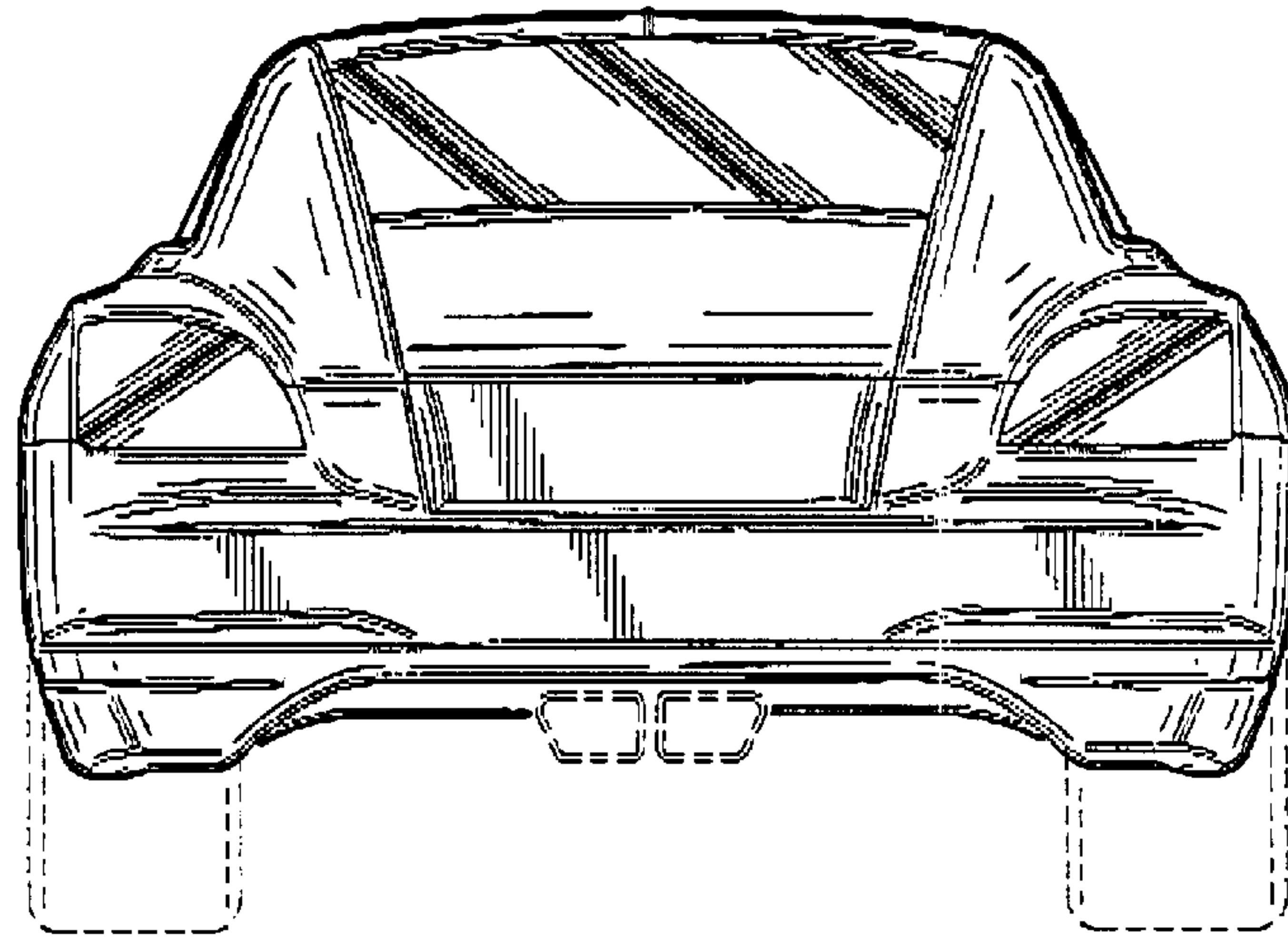

Figure - 3

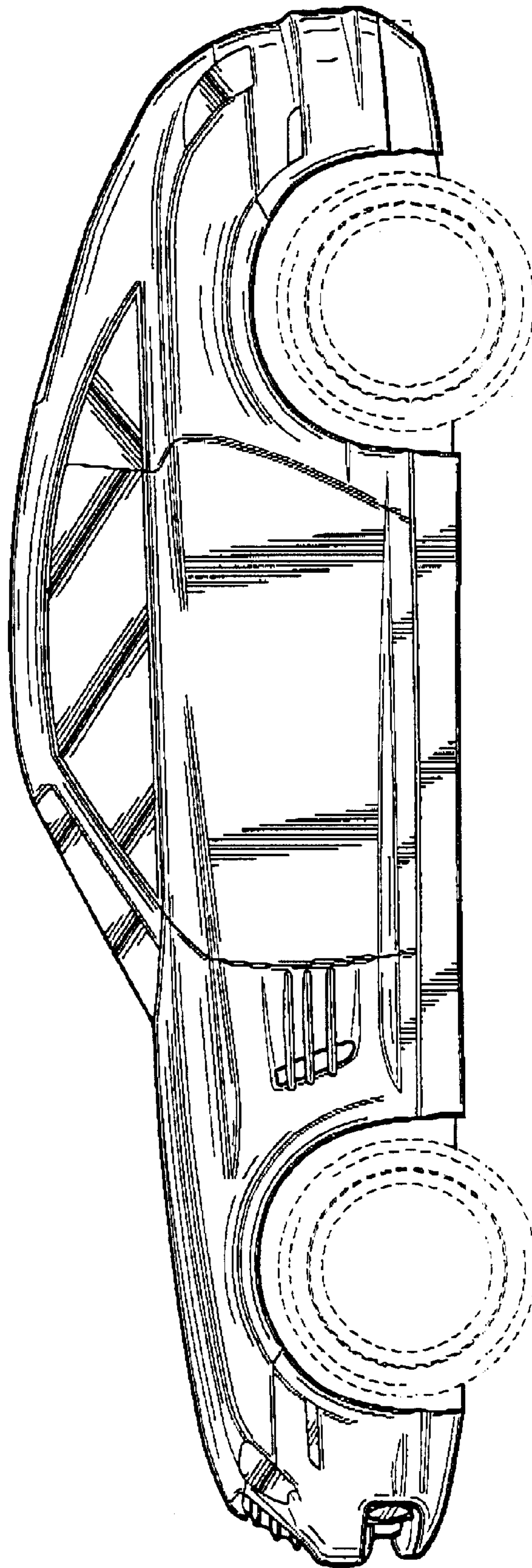

Figure - 4

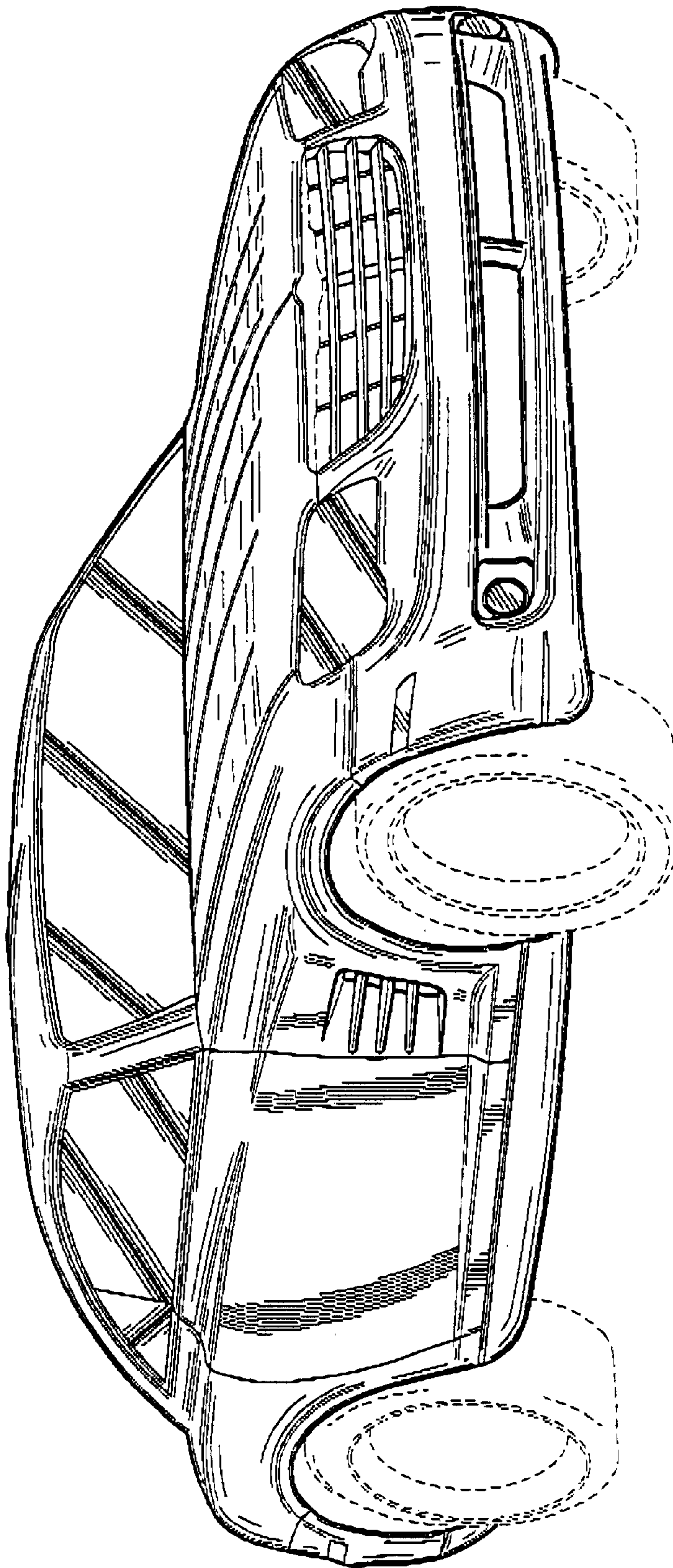

Figure - 5

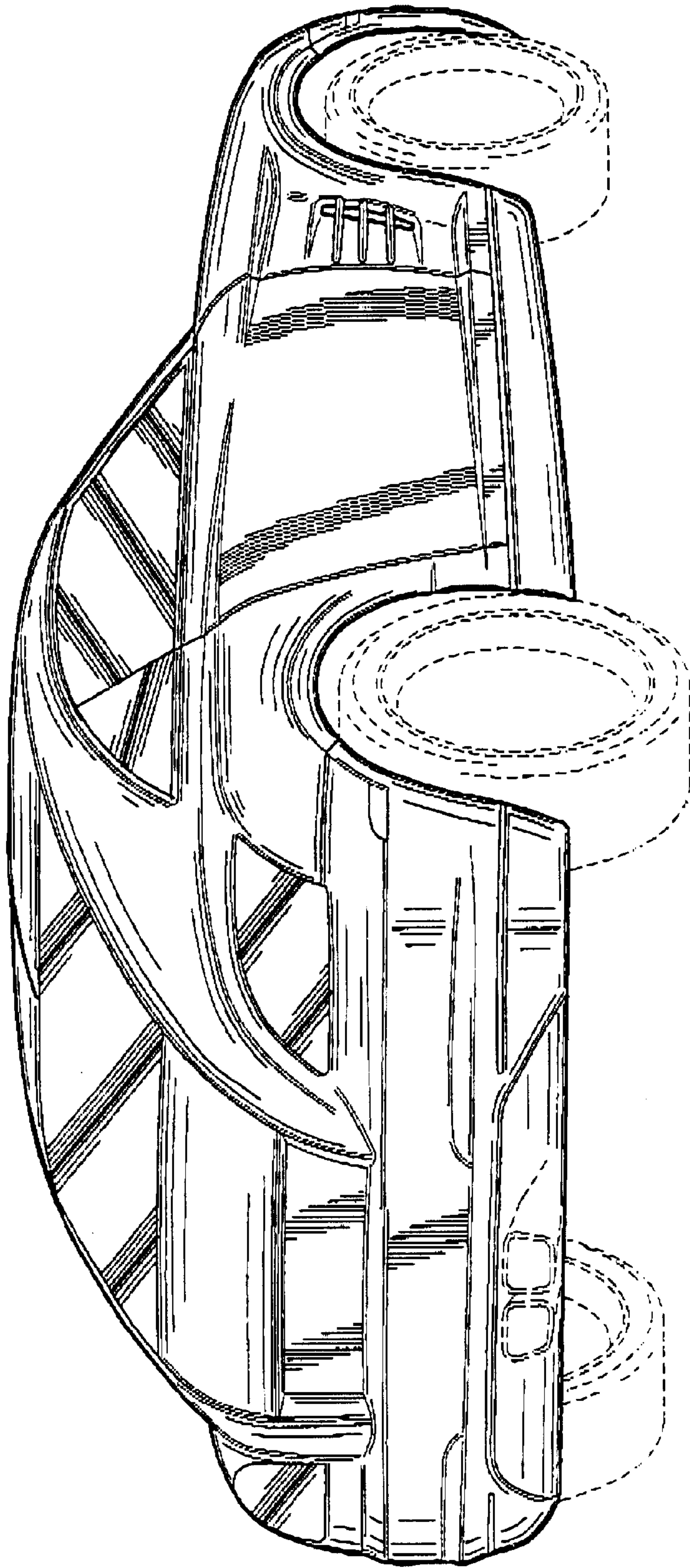

Figure - 6