



US00D476589S

(12) **United States Design Patent**  
**Blake**

(10) **Patent No.:** **US D476,589 S**

(45) **Date of Patent:** **\*\* Jul. 1, 2003**

(54) **SURVIVAL BALLOON**

(76) **Inventor:** **Douglas Edward Blake**, 1177  
Settlerway La., Goode, VA (US) 24556

(\*\*) **Term:** **14 Years**

(21) **Appl. No.:** **29/164,404**

(22) **Filed:** **Jul. 23, 2002**

(51) **LOC (7) Cl.** ..... **10-05**

(52) **U.S. Cl.** ..... **D10/109**

(58) **Field of Search** ..... D10/109; 116/209,  
116/200, 210, DIG. 8, DIG. 9; 340/691.7,  
540; 441/89, 80, 106; 446/476, 478; 244/146,  
153 R, 31

(56) **References Cited**

**U.S. PATENT DOCUMENTS**

- 3,951,260 A \* 4/1976 Frazee ..... 116/DIG. 9
- 3,964,427 A \* 6/1976 Murphy ..... 116/210
- 4,295,438 A \* 10/1981 Porter ..... 116/210
- 5,005,513 A \* 4/1991 Van Patten et al. .... 116/210
- 5,095,845 A \* 3/1992 Murphy ..... 116/210

- D436,880 S \* 1/2001 Dimand ..... D10/109
- 6,178,915 B1 \* 1/2001 Salandra ..... 116/210
- 6,244,209 B1 \* 6/2001 Agular ..... 116/210

\* cited by examiner

*Primary Examiner*—Antoine Duval Davis  
(74) *Attorney, Agent, or Firm*—Gene Scott-Patent Law &  
Venture Group

(57) **CLAIM**

The ornamental design for a “survival balloon”, as shown and described.

**DESCRIPTION**

FIG. 1 is a front elevational view of a survival balloon, showing my new design;  
FIG. 2 is a rear elevation view thereof;  
FIG. 3 is a left side elevational view thereof;  
FIG. 4 is a right side elevational view thereof;  
FIG. 5 is a top plan view thereof; and,  
FIG. 6 is a bottom plan view thereof.

The letter characters shown in the figures are not a part of the design or claim of this patent application.

**1 Claim, 5 Drawing Sheets**

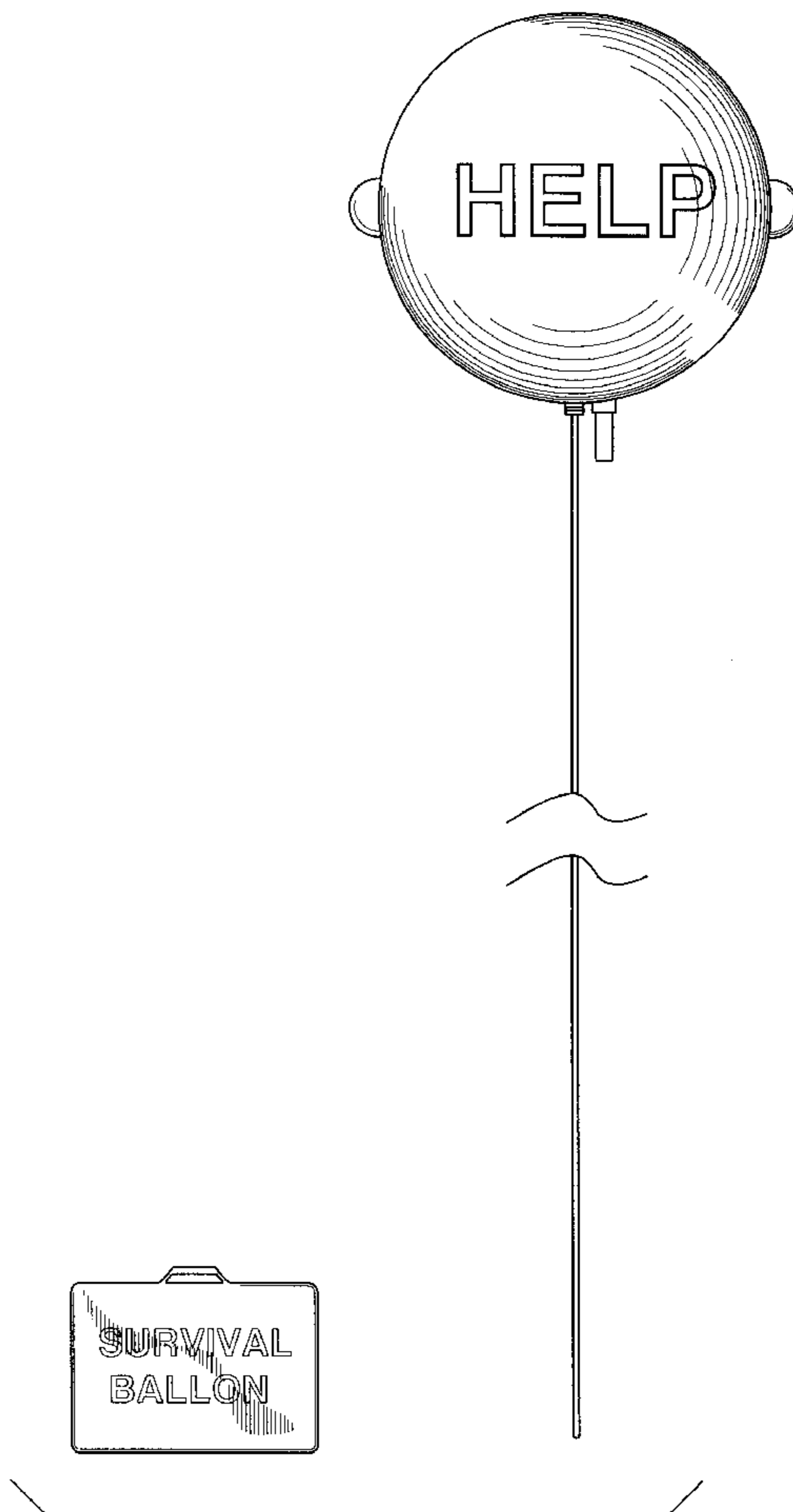
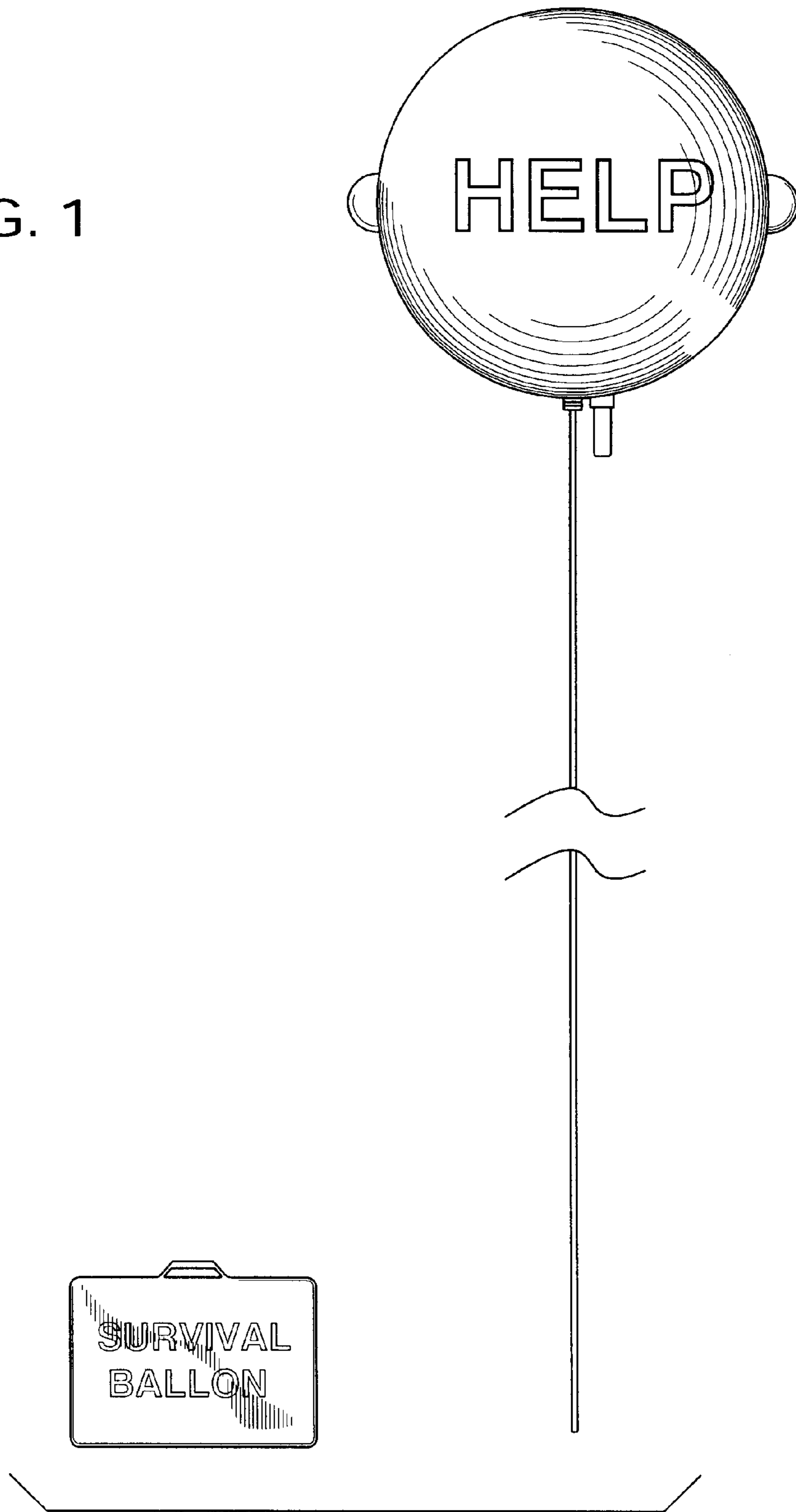

FIG. 1



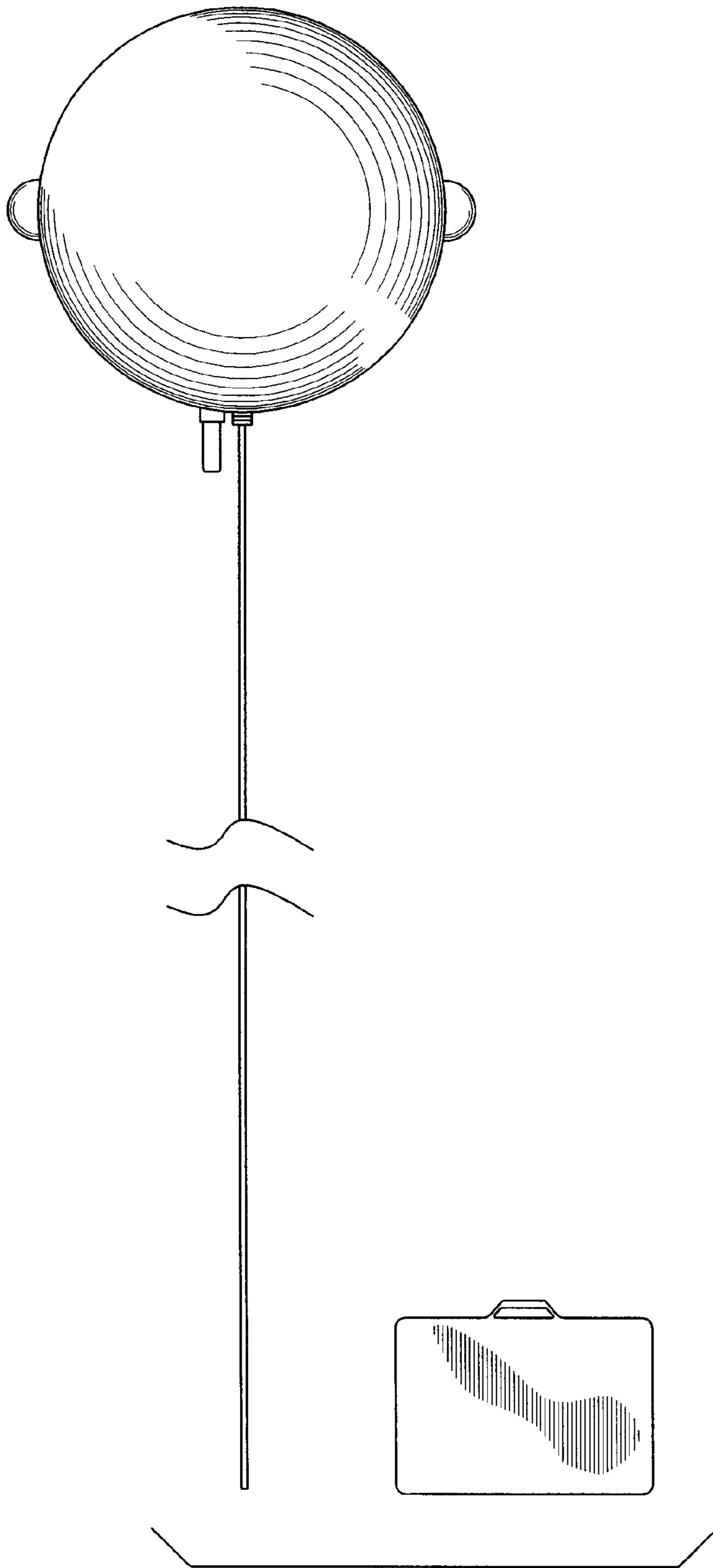

FIG. 2

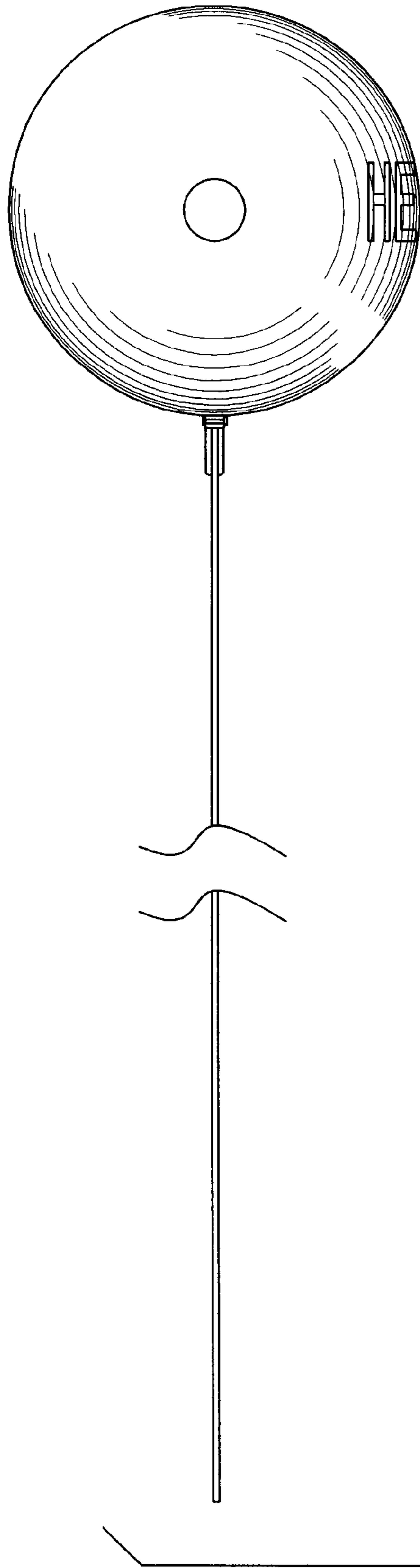

FIG. 3

FIG. 4

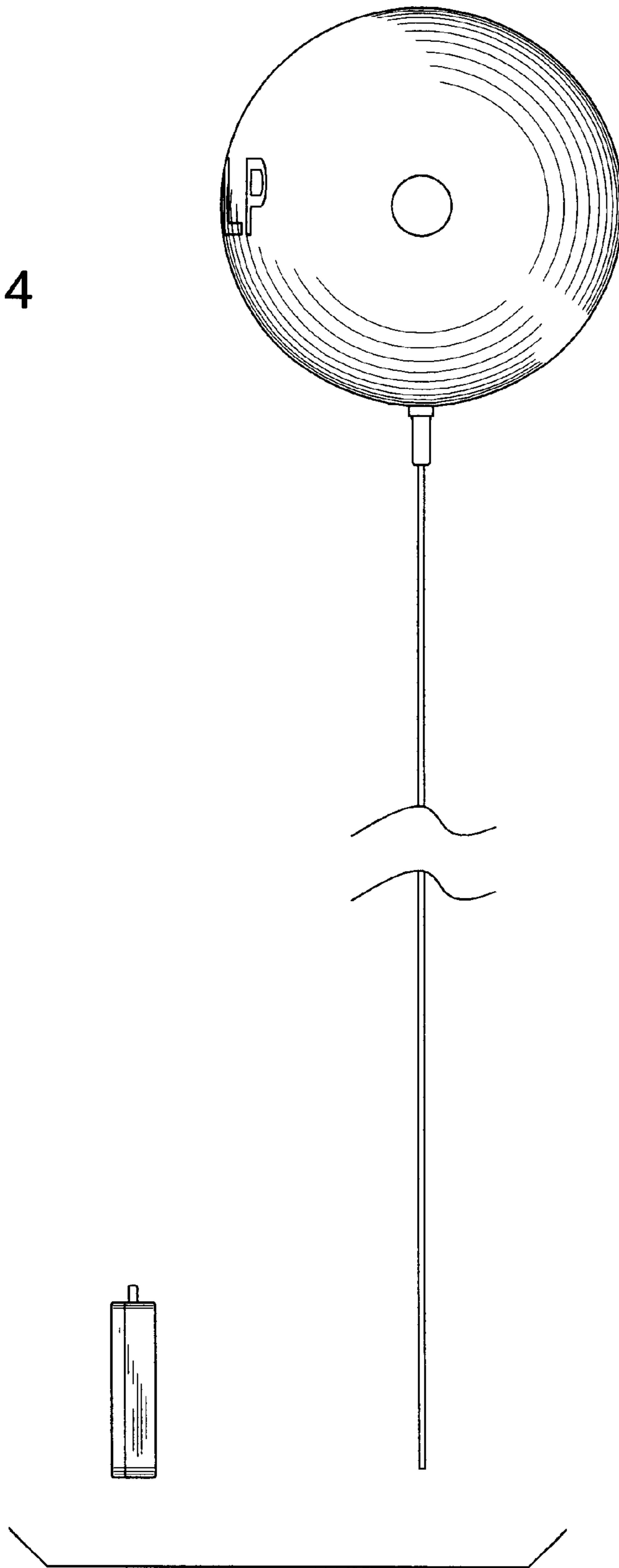

FIG. 5

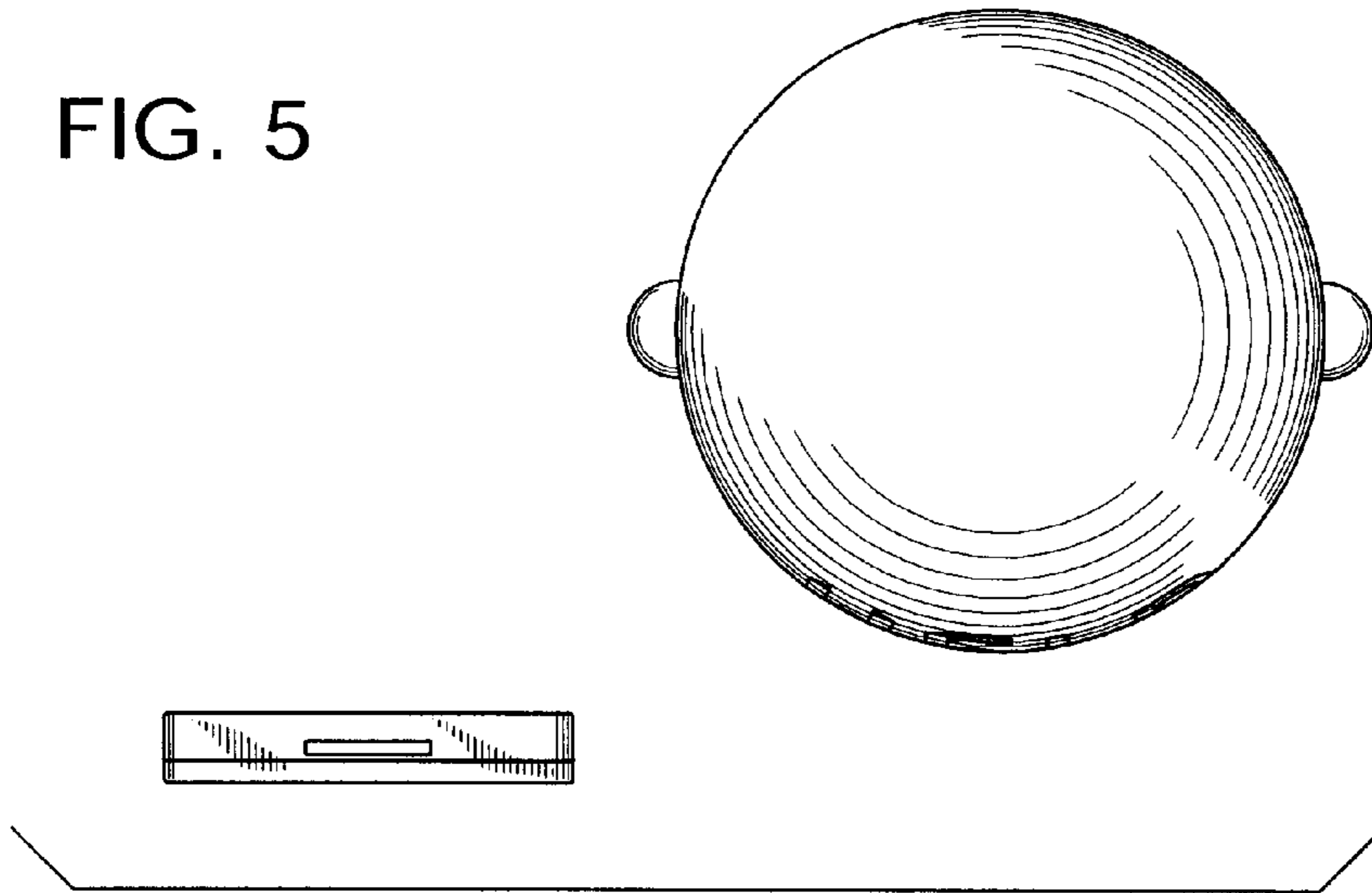

FIG. 6

