



US00D476549S

(12) **United States Design Patent**
Shaw

(10) **Patent No.:** **US D476,549 S**

(45) **Date of Patent:** **** Jul. 1, 2003**

(54) **SWITCH TRIM PLATE**

(76) Inventor: **David Shaw**, 1558 Powell St., San Francisco, CA (US) 94133

(**) Term: **14 Years**

(21) Appl. No.: **29/146,972**

(22) Filed: **Aug. 20, 2001**

(51) **LOC (7) Cl.** **11-05**

(52) **U.S. Cl.** **D8/353; D8/350**

(58) **Field of Search** **D8/350-353; D13/177; 174/66; 220/341; 439/536**

(56) **References Cited**

U.S. PATENT DOCUMENTS

D183,396 S	*	8/1958	Koch	D8/353
D185,005 S	*	4/1959	Kubota	D8/350
D185,190 S	*	5/1959	Clayton	D8/352
D228,061 S	*	8/1973	Kartarik	D8/350
D284,261 S	*	6/1986	Sorenson	D8/353

OTHER PUBLICATIONS

Leviton Catalog; p. 13; two rows of switch plates and opening arrangements below.*

* cited by examiner

Primary Examiner—B. J. Bullock
(74) *Attorney, Agent, or Firm*—Jack Lo

(57) **CLAIM**

The ornamental design for a switch trim plate, as shown and described.

DESCRIPTION

FIG. 1 is a front perspective view of a switch trim plate showing a first embodiment of my new design.
 FIG. 2 is a front view thereof.
 FIG. 3 is a rear view thereof.
 FIG. 4 is a top view thereof.
 FIG. 5 is a bottom view thereof.
 FIG. 6 is a left side view thereof.
 FIG. 7 is a right side view thereof.
 FIG. 8 is a front perspective view of a switch trim plate showing a second embodiment of my new design.

FIG. 9 is a front view thereof.
 FIG. 10 is a rear view thereof.
 FIG. 11 is a top view thereof.
 FIG. 12 is a bottom view thereof.
 FIG. 13 is a left side view thereof.
 FIG. 14 is a right side view thereof.
 FIG. 15 is a front perspective view of a switch trim plate showing a third embodiment of my new design.
 FIG. 16 is a front view thereof.
 FIG. 17 is a rear view thereof.
 FIG. 18 is a top view thereof.
 FIG. 19 is a bottom view thereof.
 FIG. 20 is a left side view thereof.
 FIG. 21 is a right side view thereof.
 FIG. 22 is a front perspective view of a switch trim plate showing a fourth embodiment of my new design.
 FIG. 23 is a front view thereof.
 FIG. 24 is a rear view thereof.
 FIG. 25 is a top view thereof.
 FIG. 26 is a bottom view thereof.
 FIG. 27 is a left side view thereof.
 FIG. 28 is a right side view thereof.
 FIG. 29 is a front perspective view of a switch trim plate showing a fifth embodiment of my new design.
 FIG. 30 is a front view thereof.
 FIG. 31 is a rear view thereof.
 FIG. 32 is a top view thereof.
 FIG. 33 is a bottom view thereof.
 FIG. 34 is a left side view thereof.
 FIG. 35 is a right side view thereof.
 FIG. 36 is a front perspective view of a switch trim plate showing a sixth embodiment of my new design.
 FIG. 37 is a front view thereof.
 FIG. 38 is a rear view thereof.
 FIG. 39 is a top view thereof.
 FIG. 40 is a bottom view thereof.
 FIG. 41 is a left side view thereof; and,
 FIG. 42 is a right side view thereof.

The broken lines which define the bounds of the claimed design form no part thereof.

The present switch trim plate has a central flat surface with an oval border on a front side. A rectangular switch hole is arranged on the flat surface. A convex surface extends between the oval border of the flat surface and the edges of the plate.

1 Claim, 20 Drawing Sheets

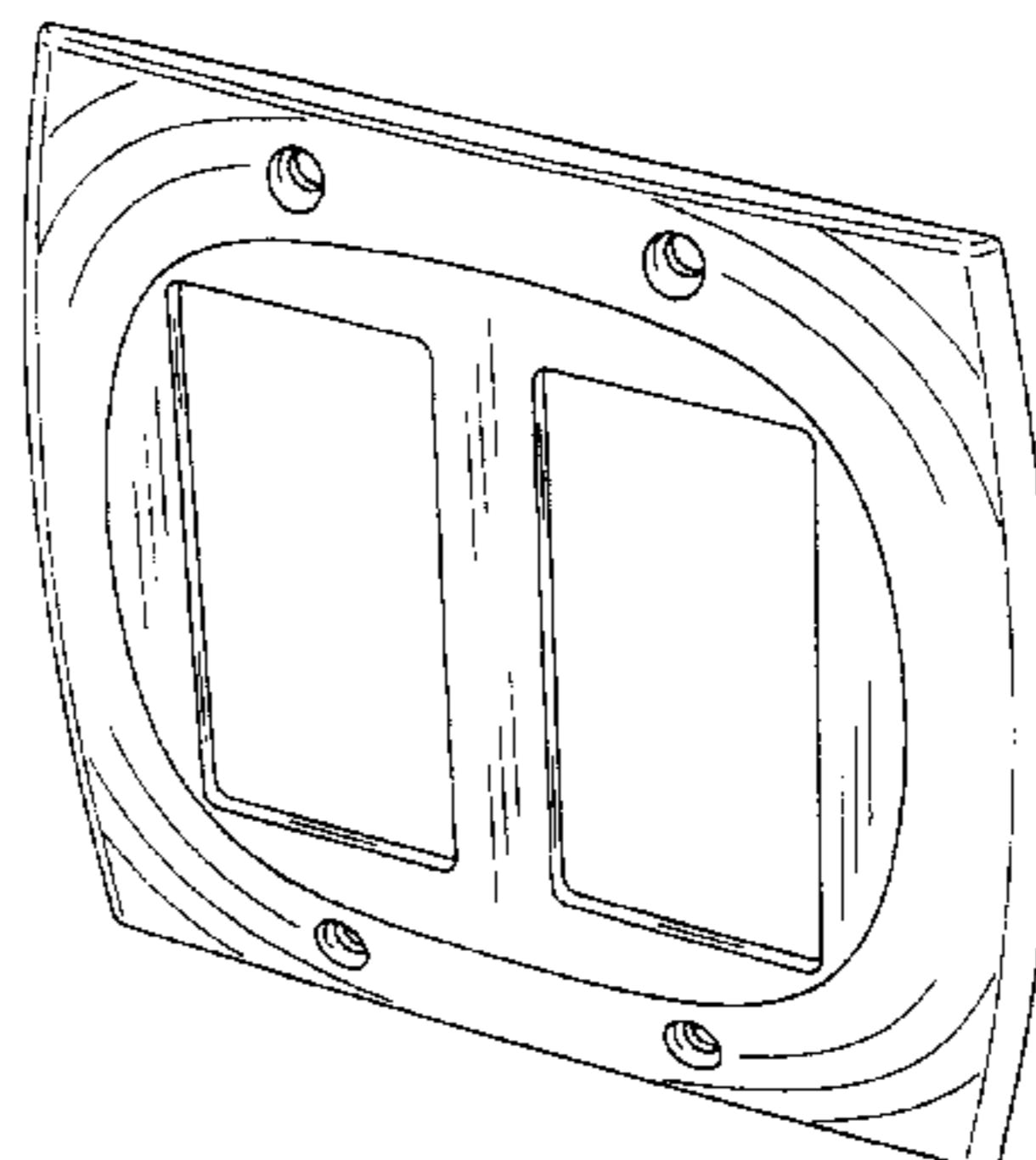
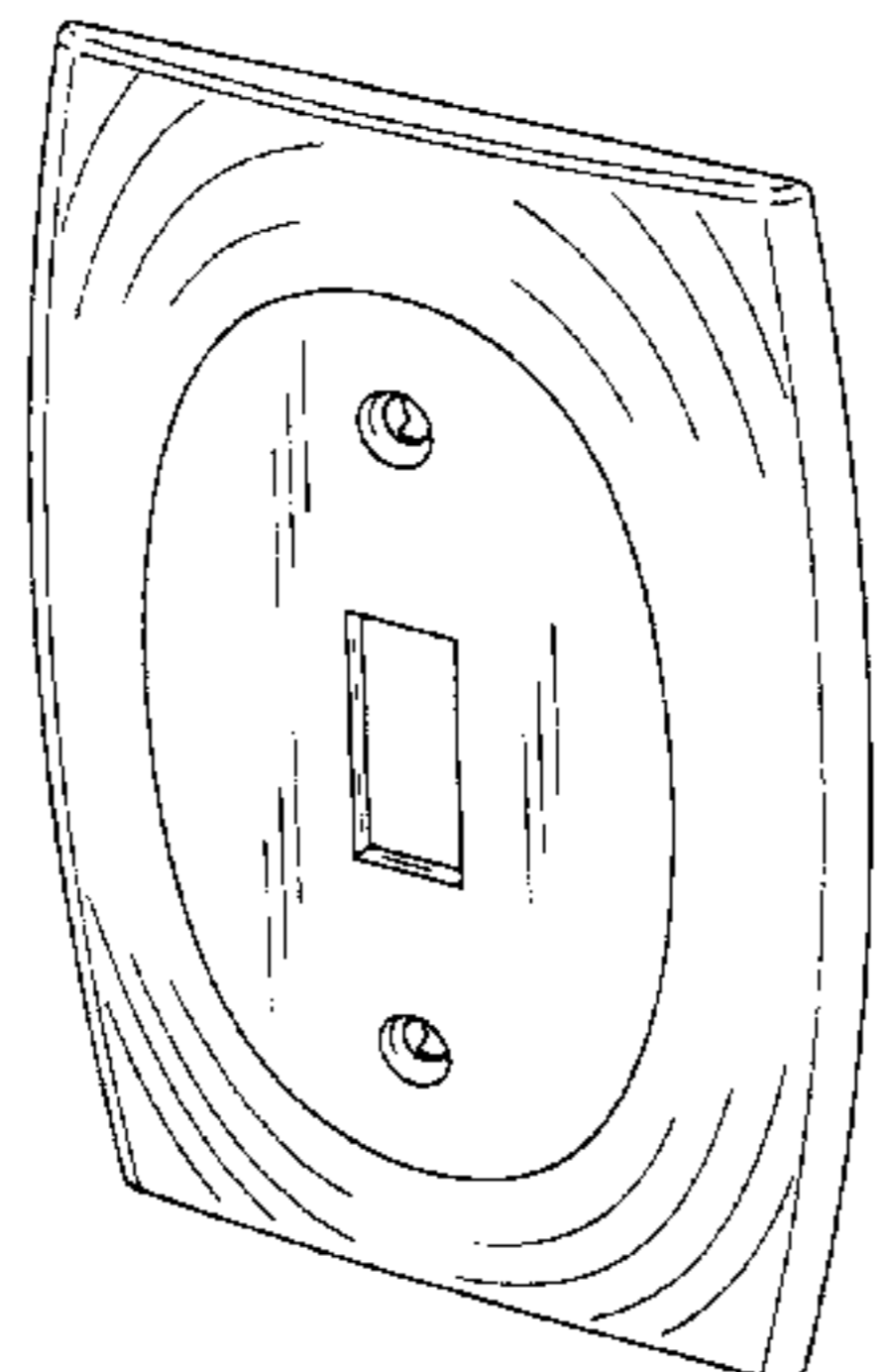

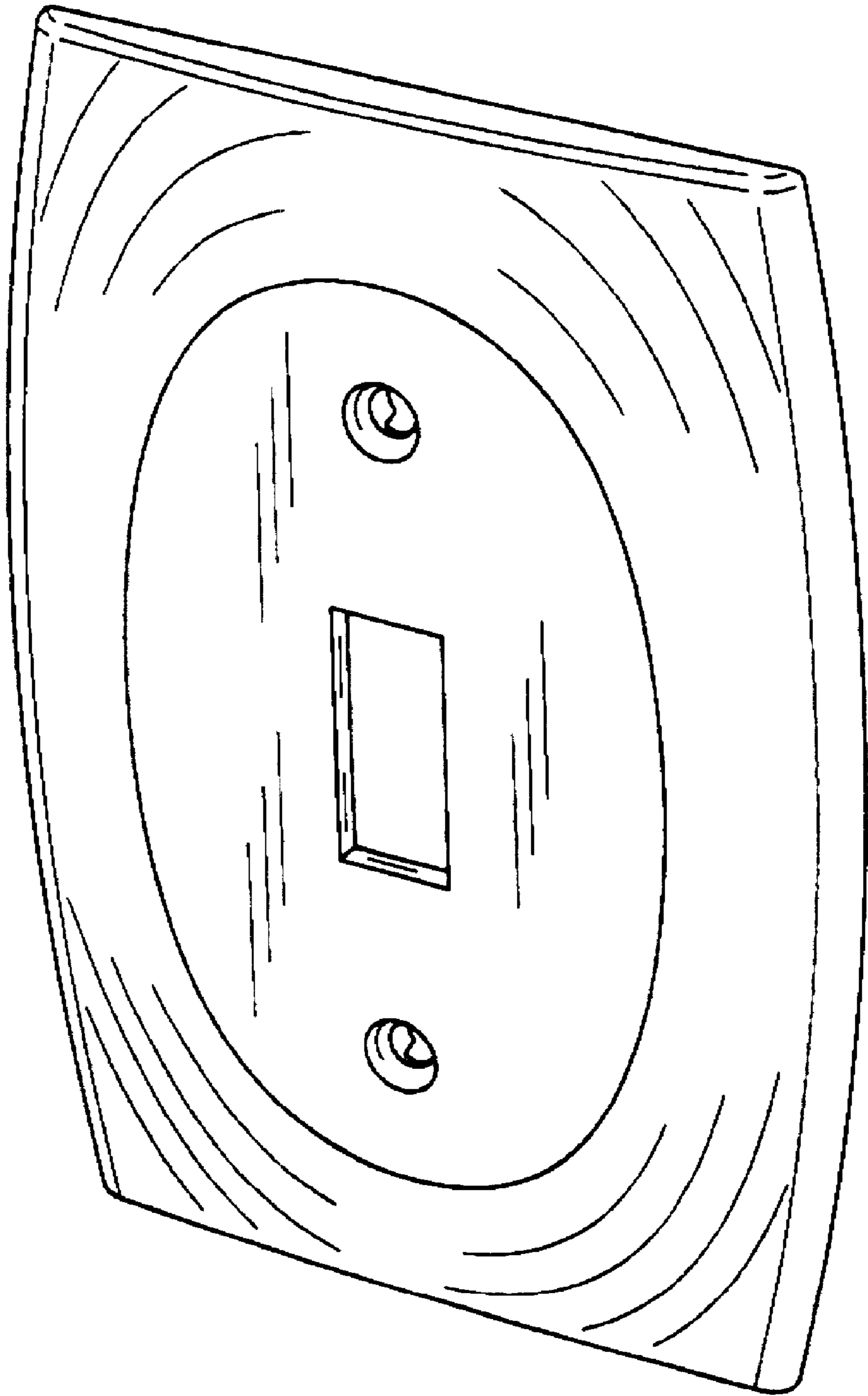

Fig. 1

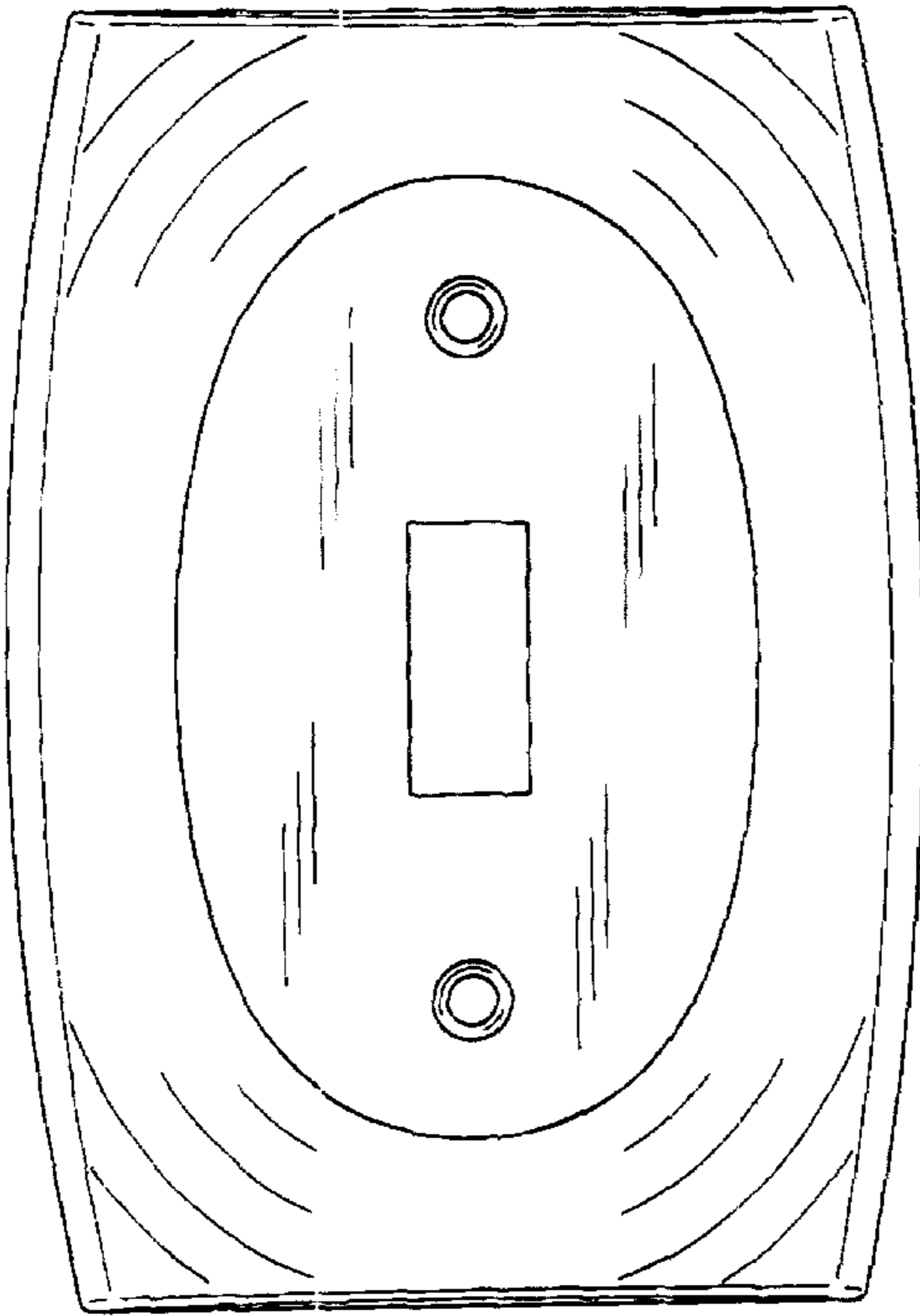

Fig. 2

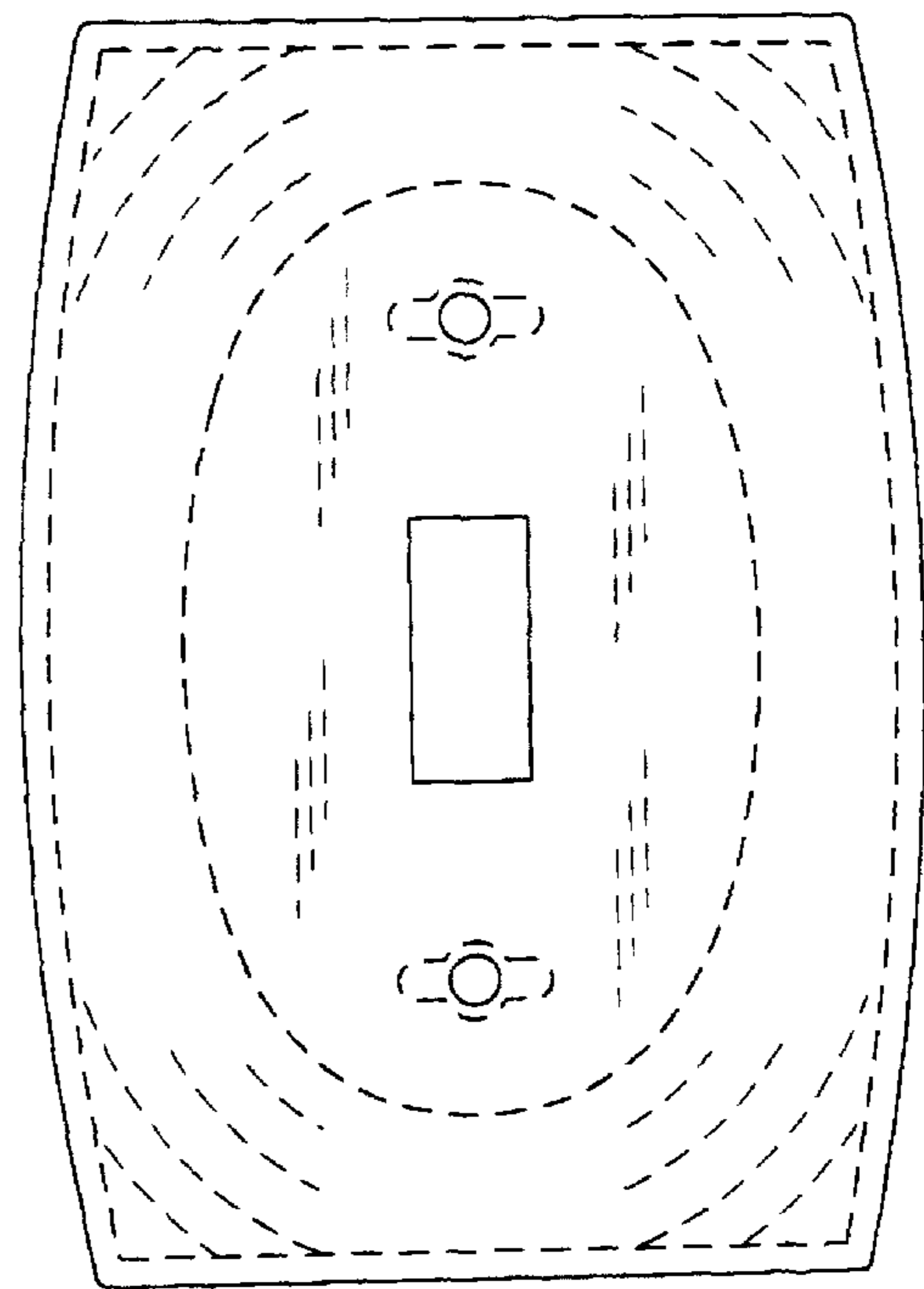

Fig. 3

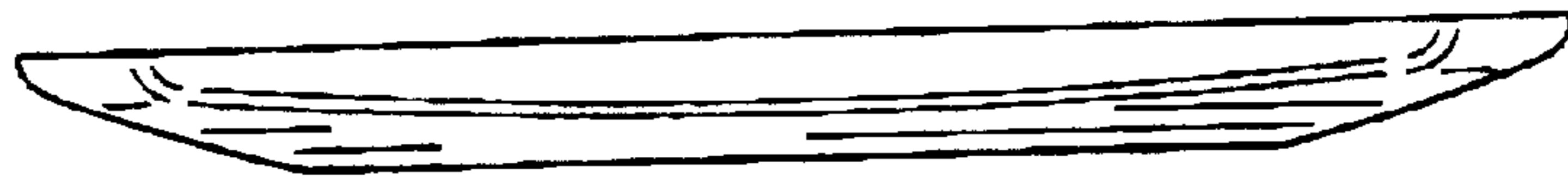

Fig. 4

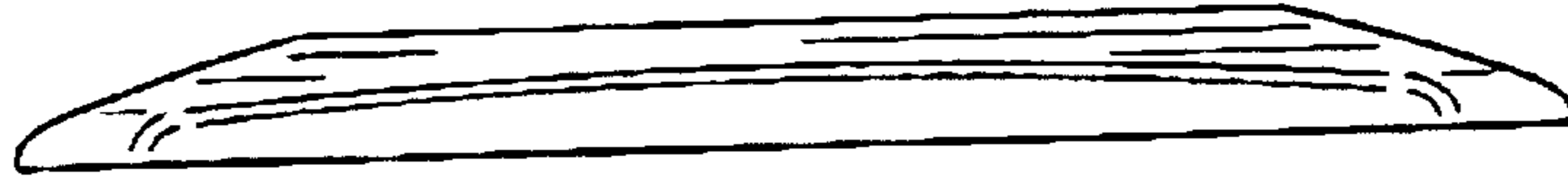

Fig. 5



Fig. 6



Fig. 7

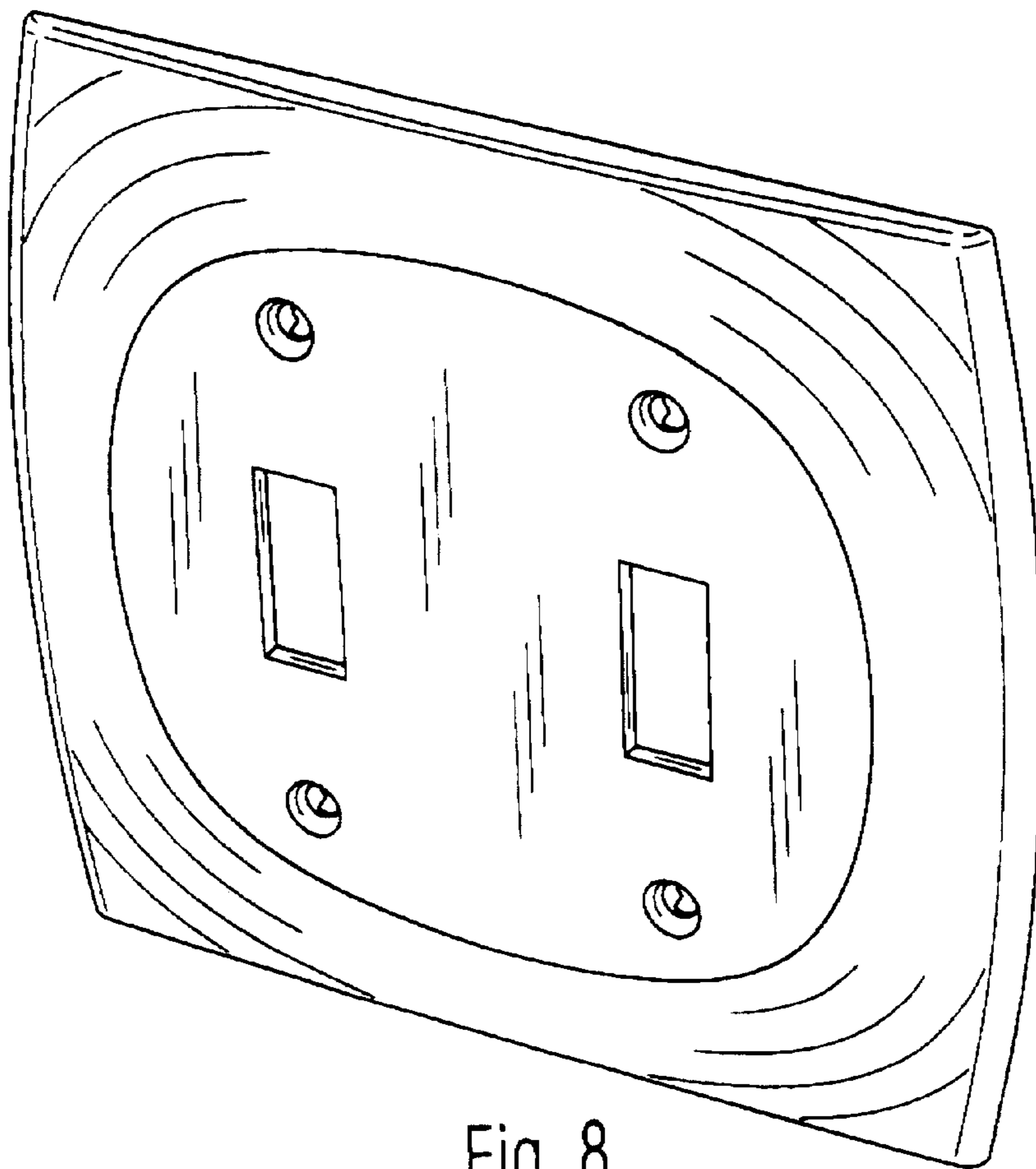

Fig. 8

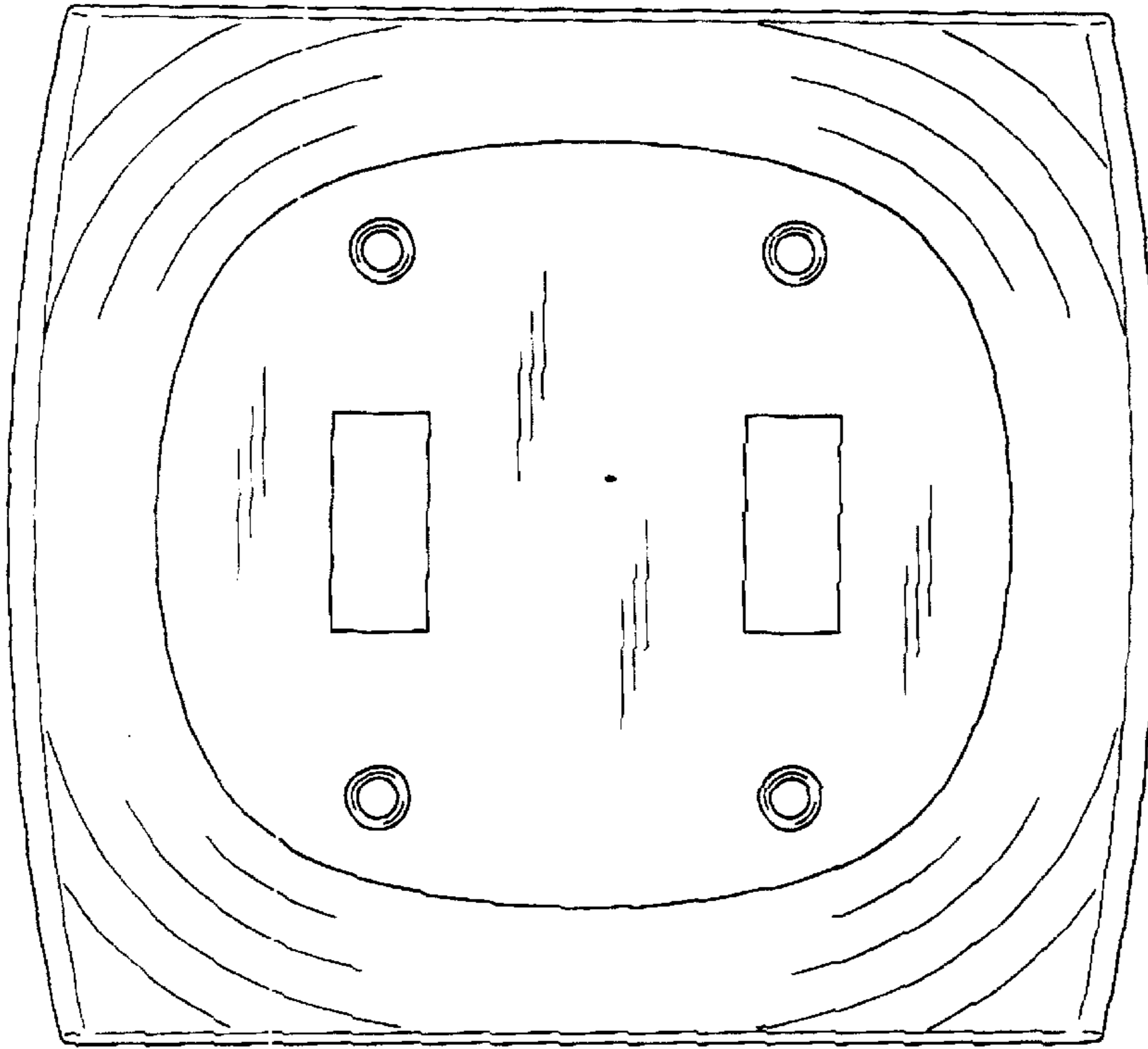

Fig. 9

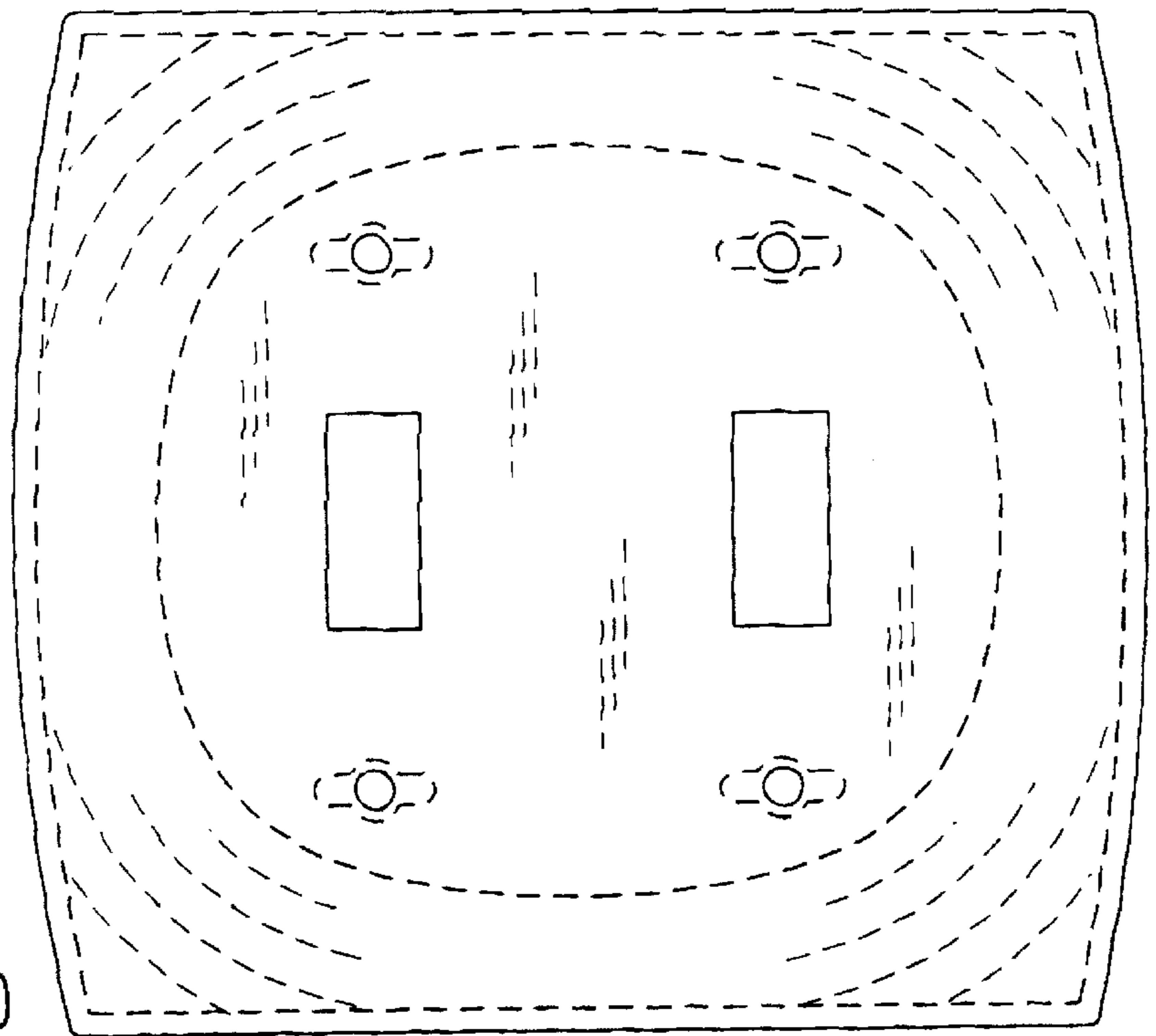

Fig. 10

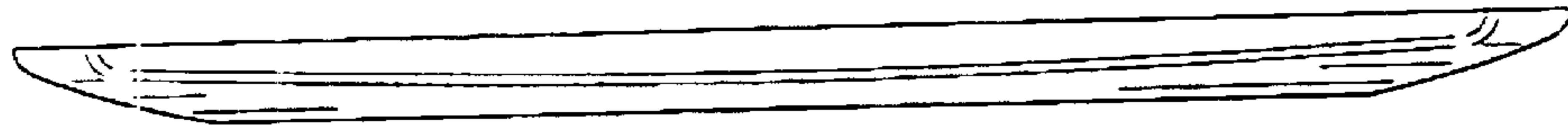

Fig. 11

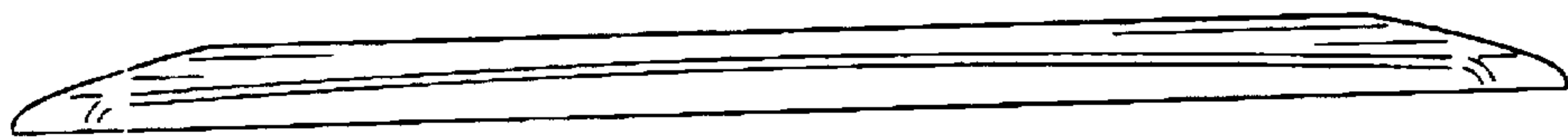

Fig. 12

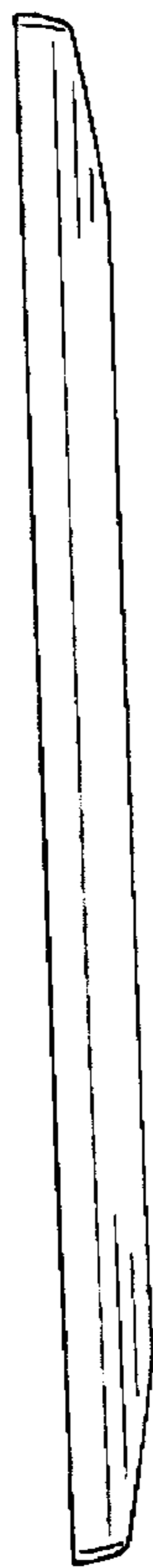

Fig. 13



Fig. 14

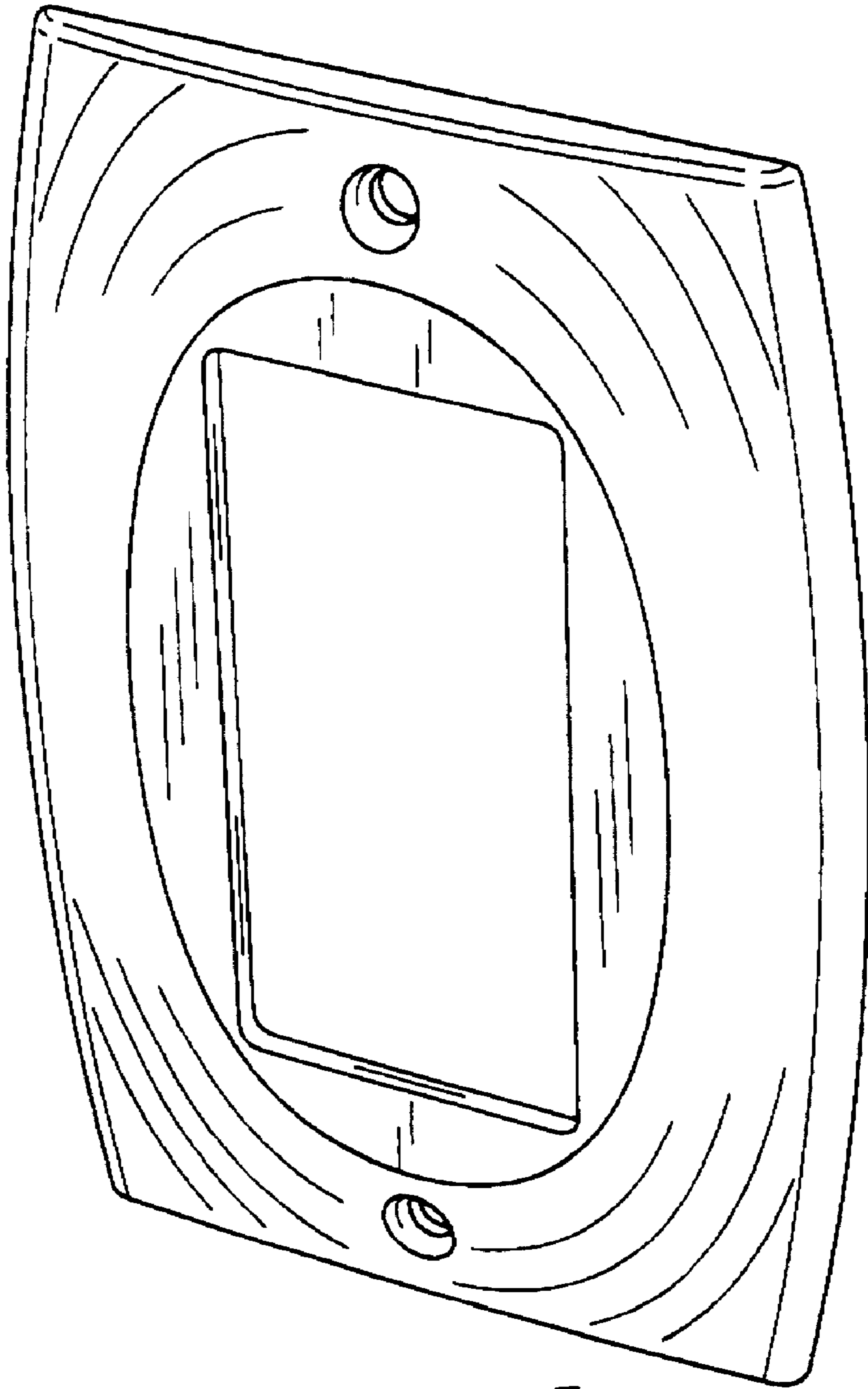

Fig. 15

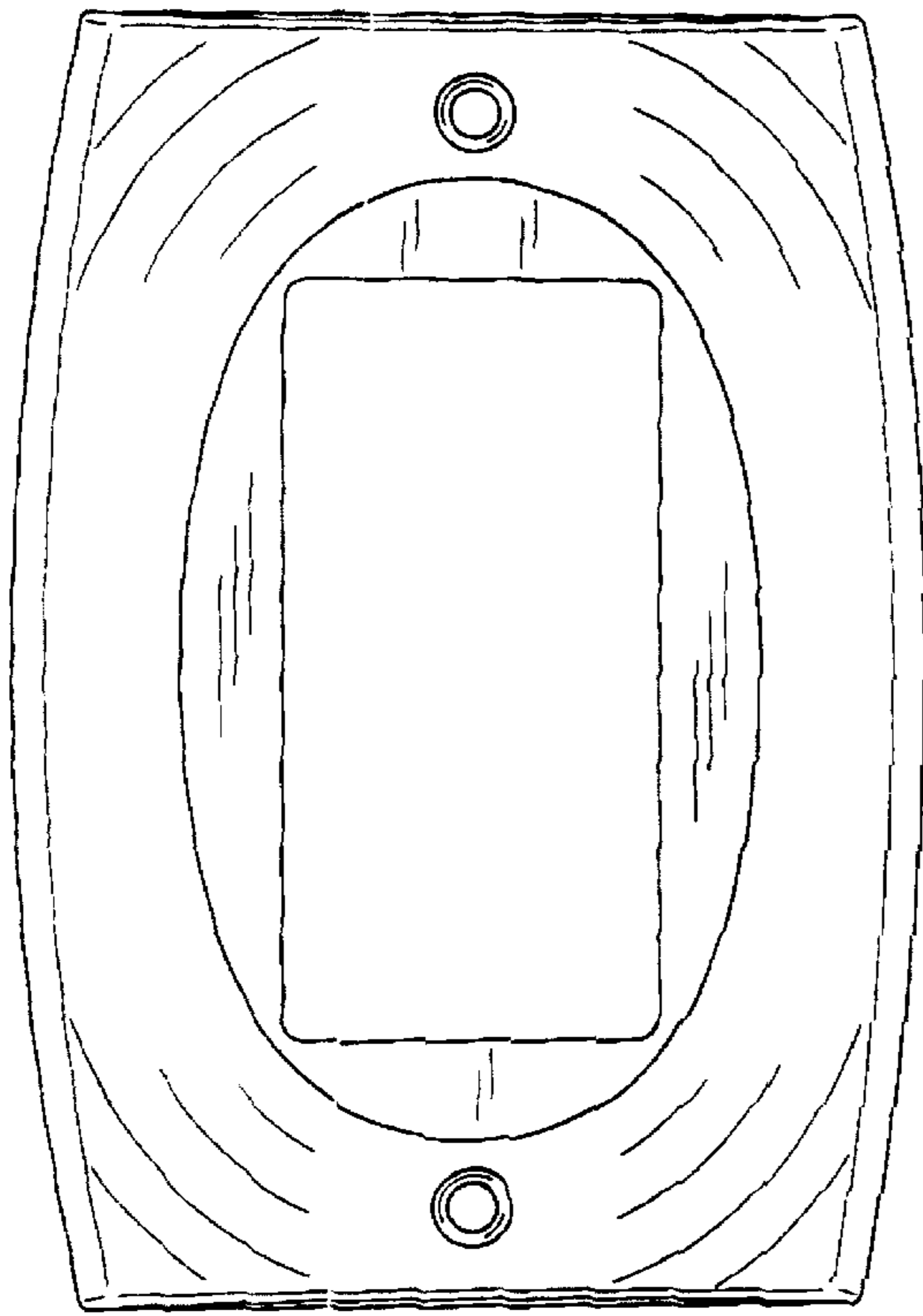

Fig. 16

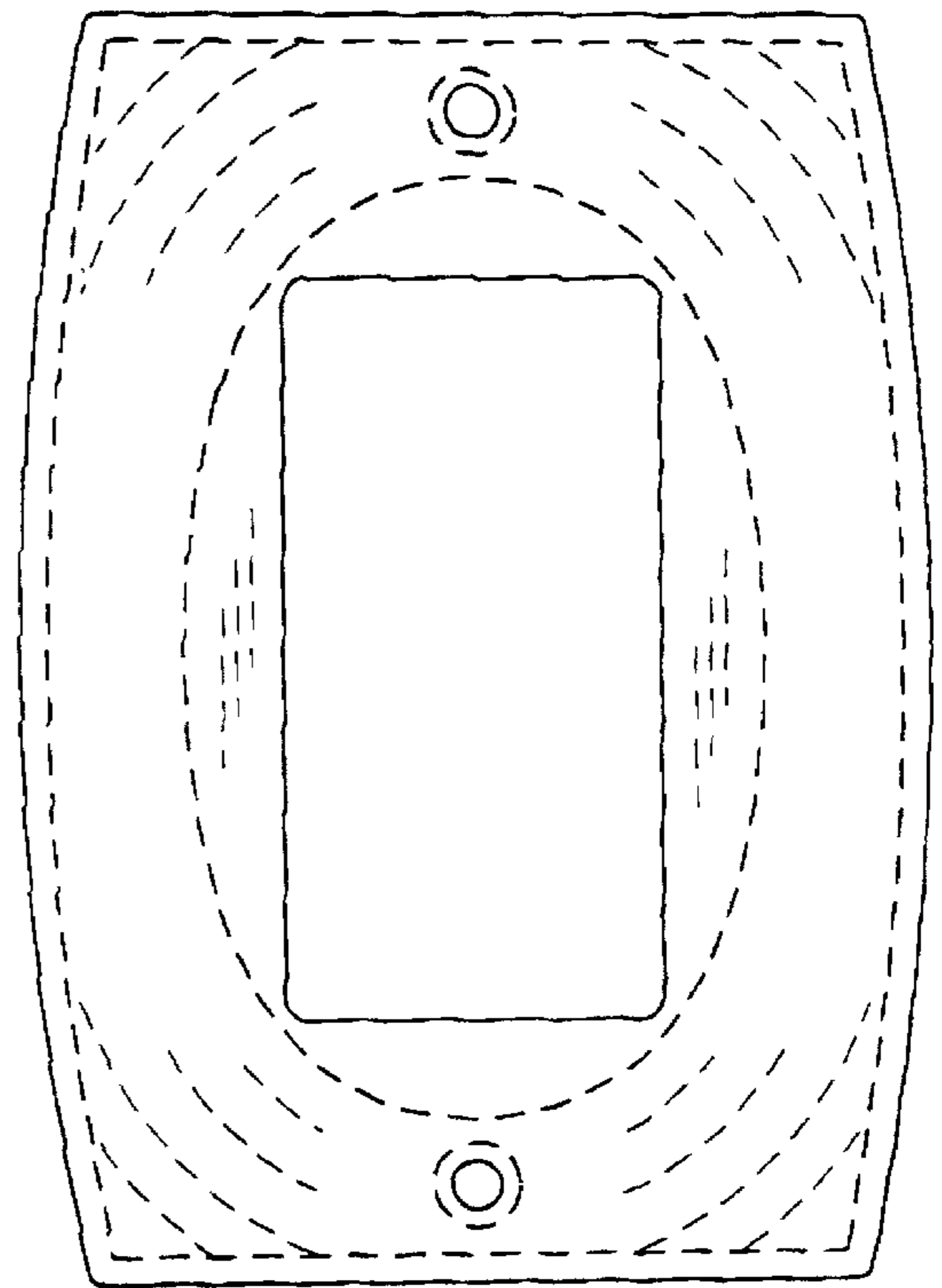

Fig. 17

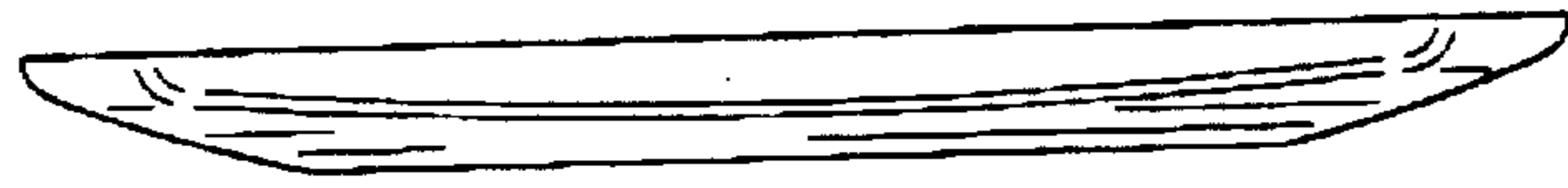

Fig. 18

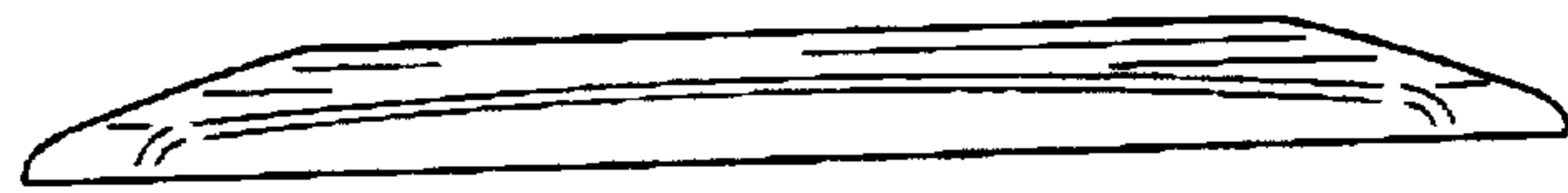

Fig. 19



Fig. 20



Fig. 21

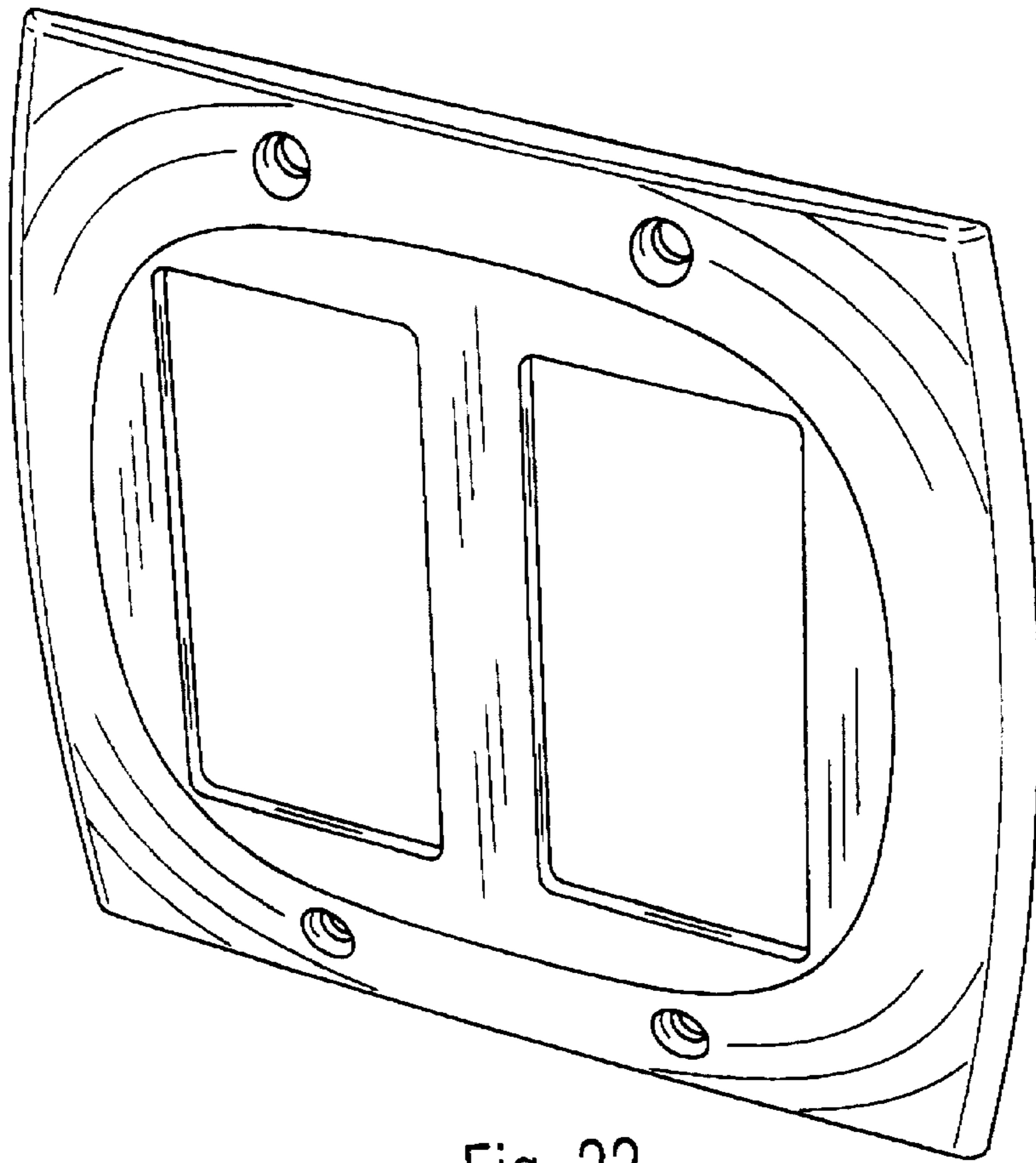

Fig. 22

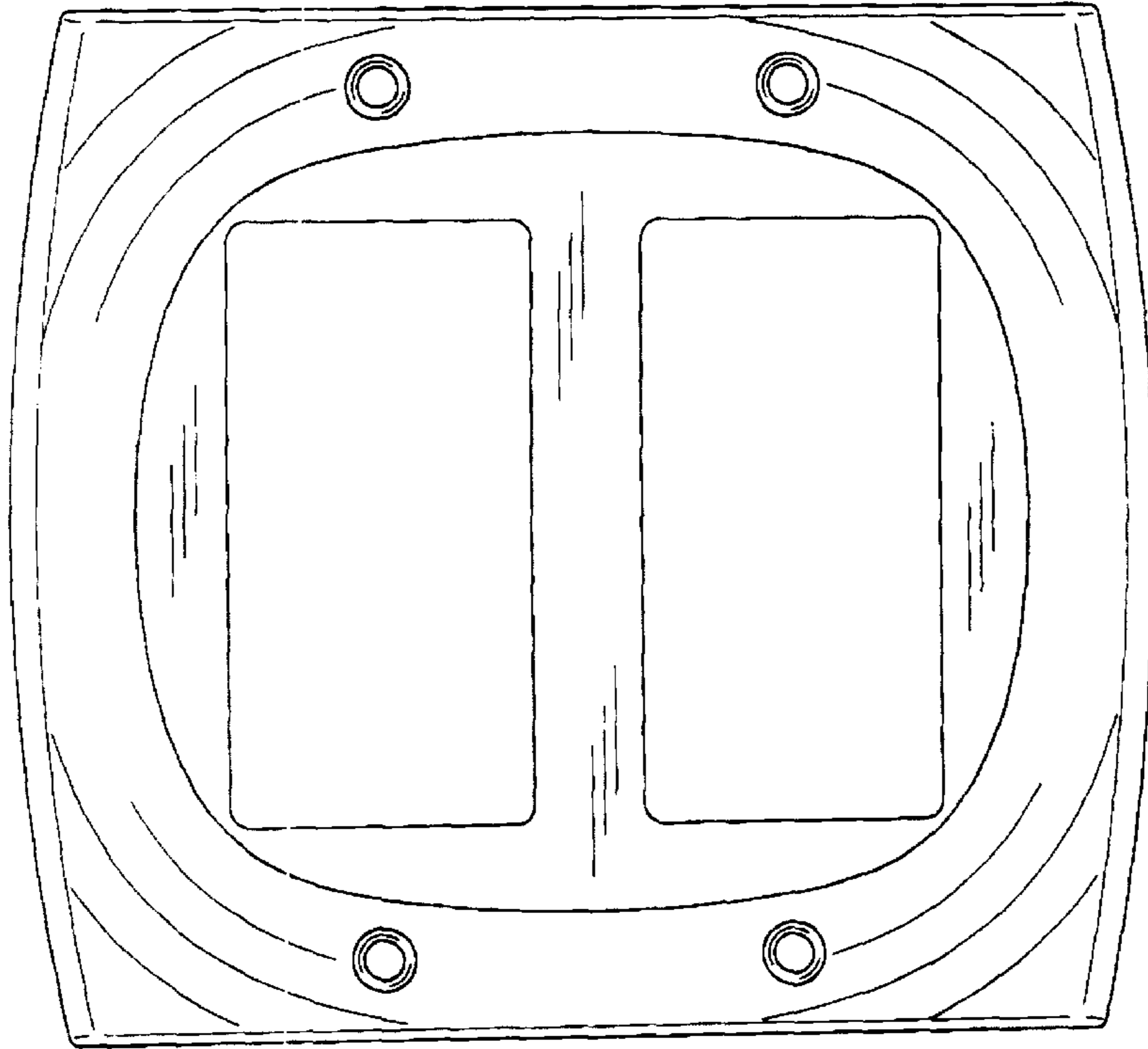

Fig. 23

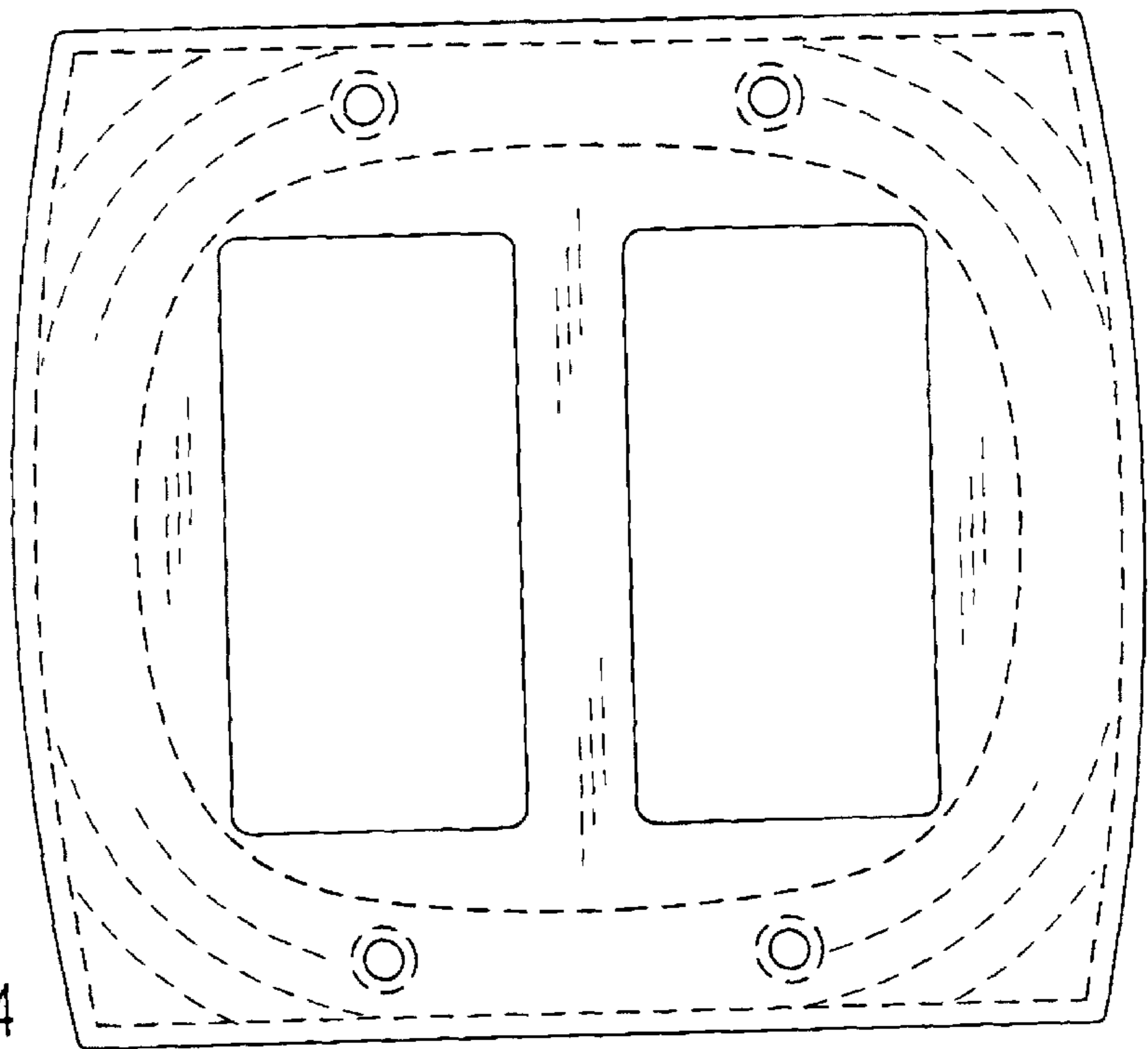

Fig. 24

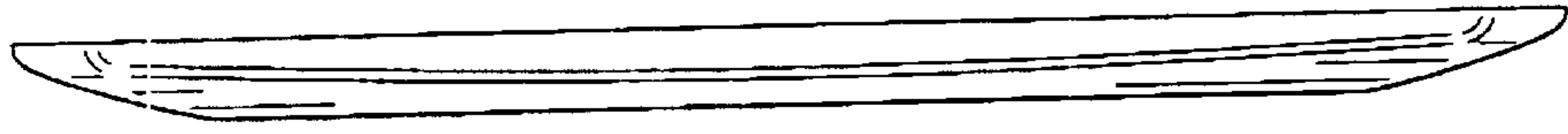

Fig. 25

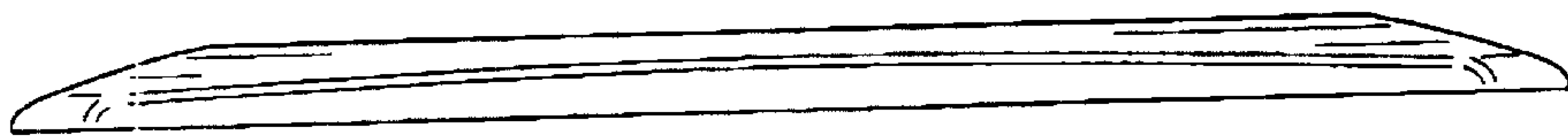

Fig. 26

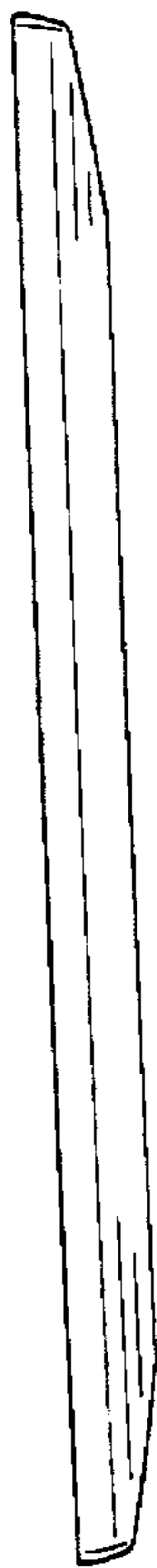

Fig. 27



Fig. 28

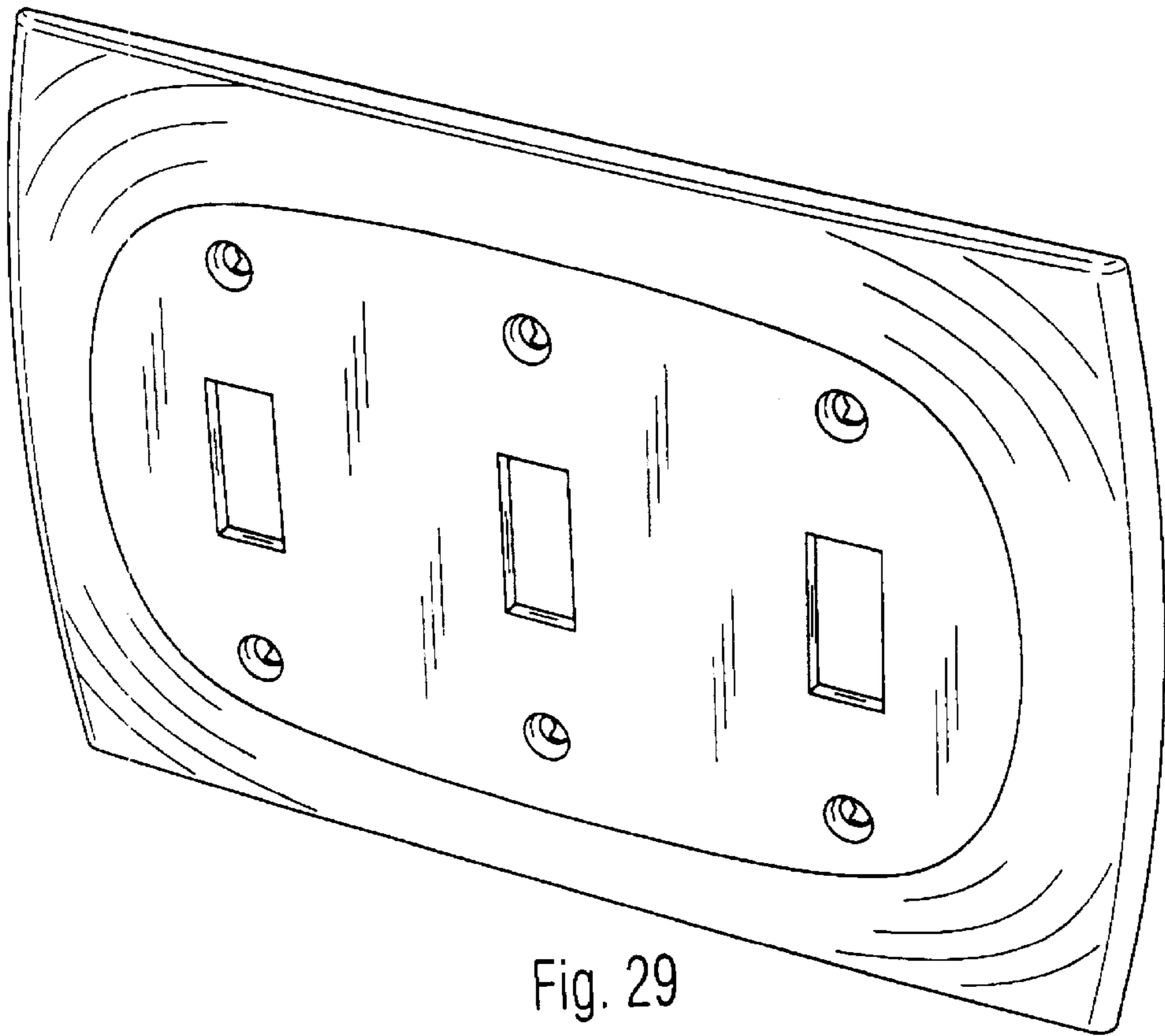

Fig. 29

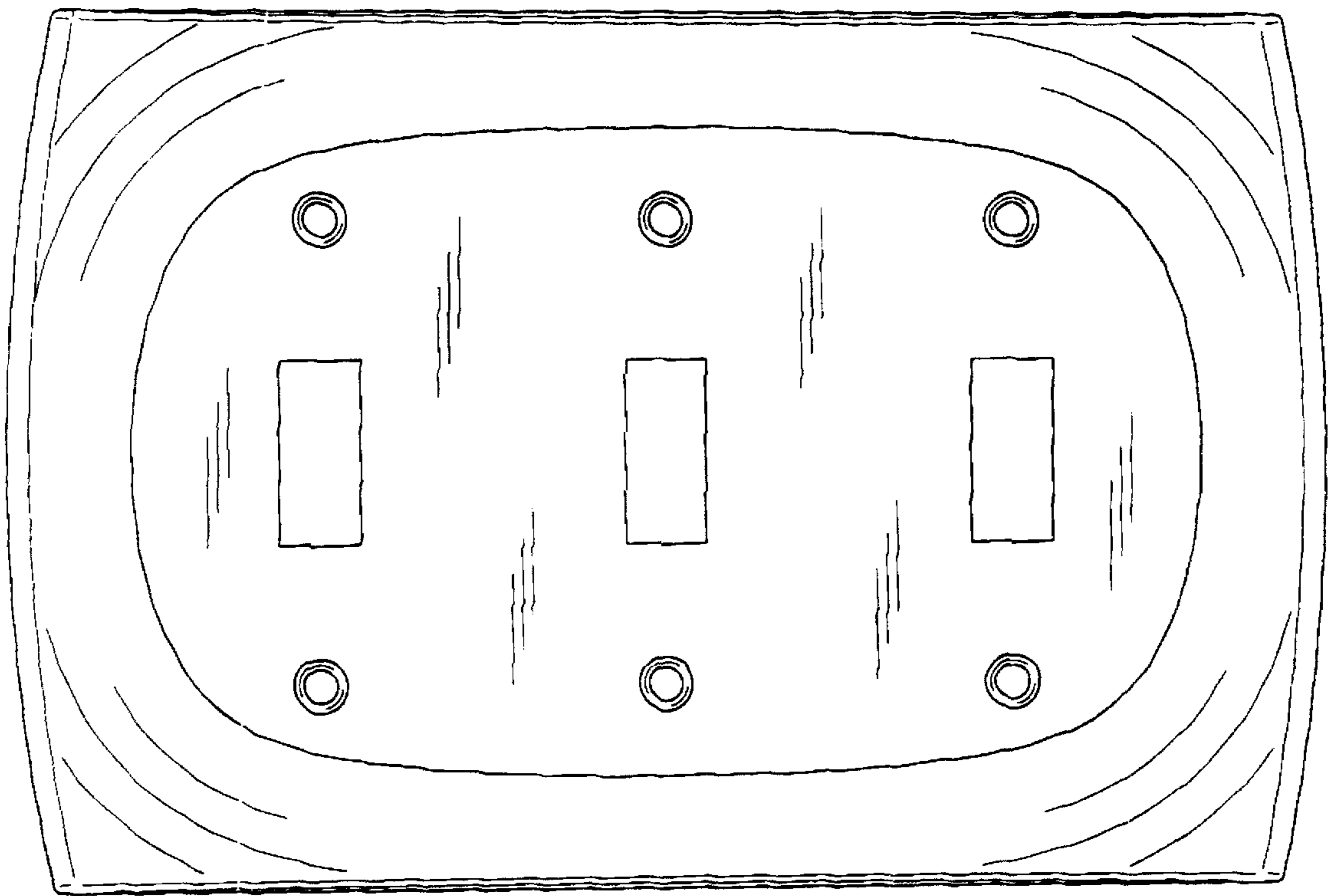

Fig. 30

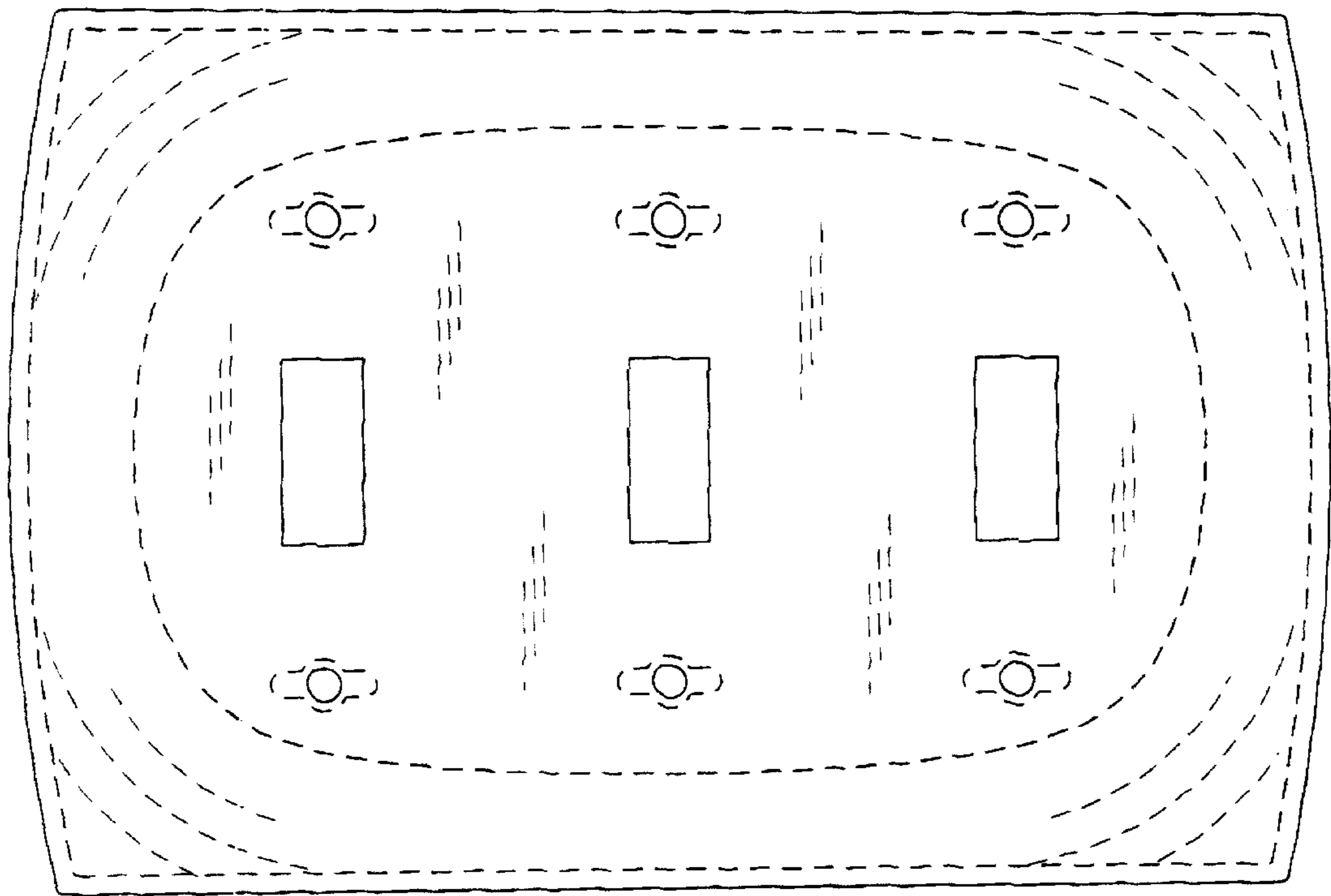

Fig. 31

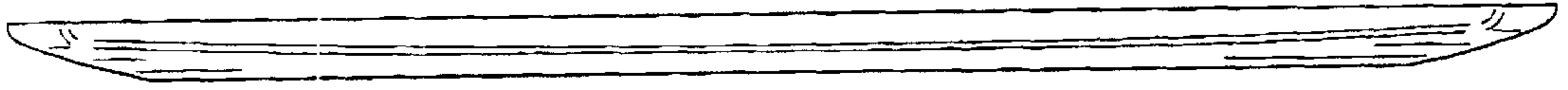

Fig. 32

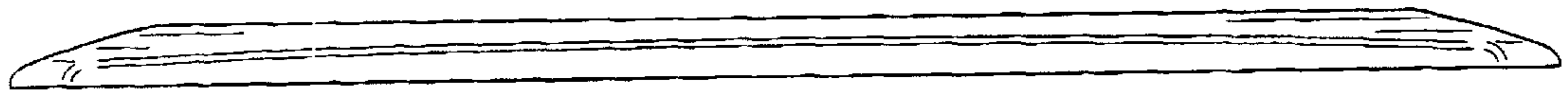

Fig. 33

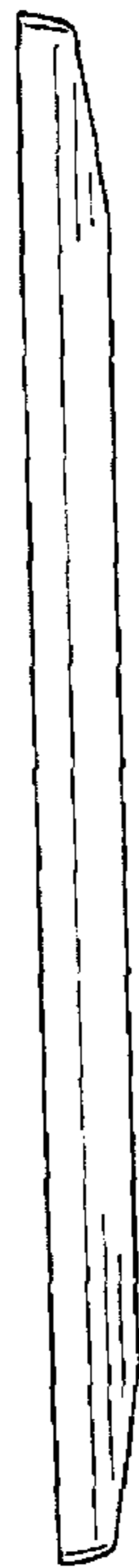

Fig. 34

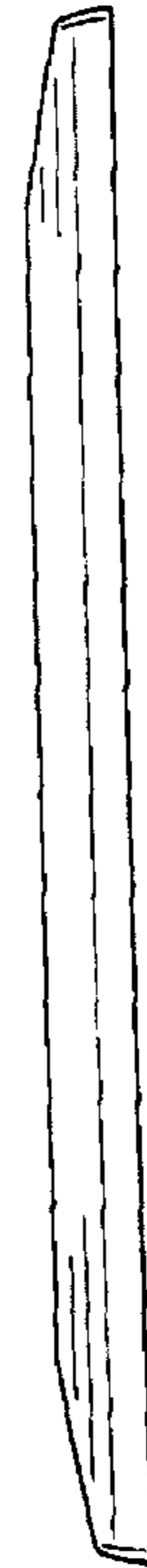

Fig. 35

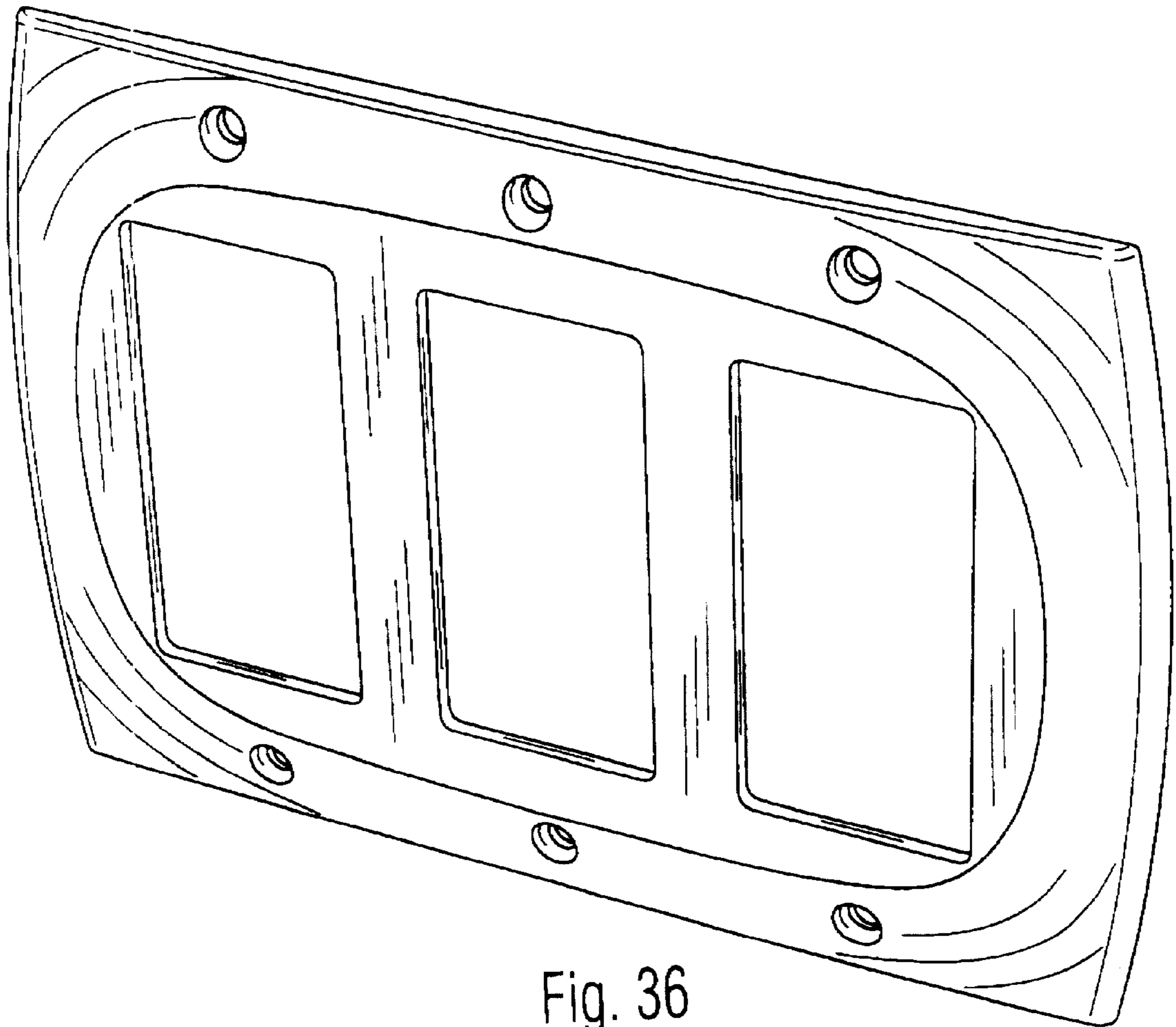

Fig. 36

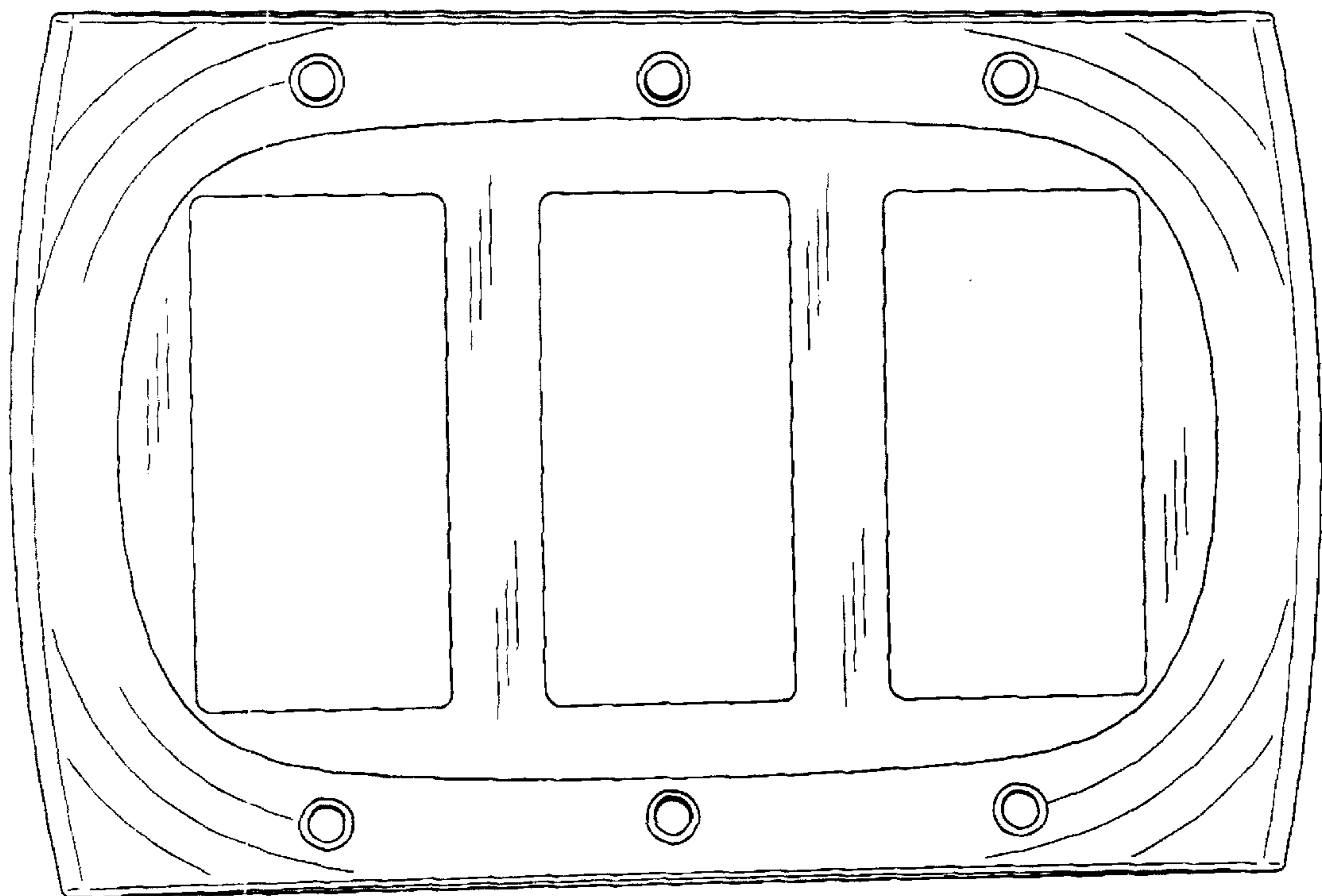

Fig. 37

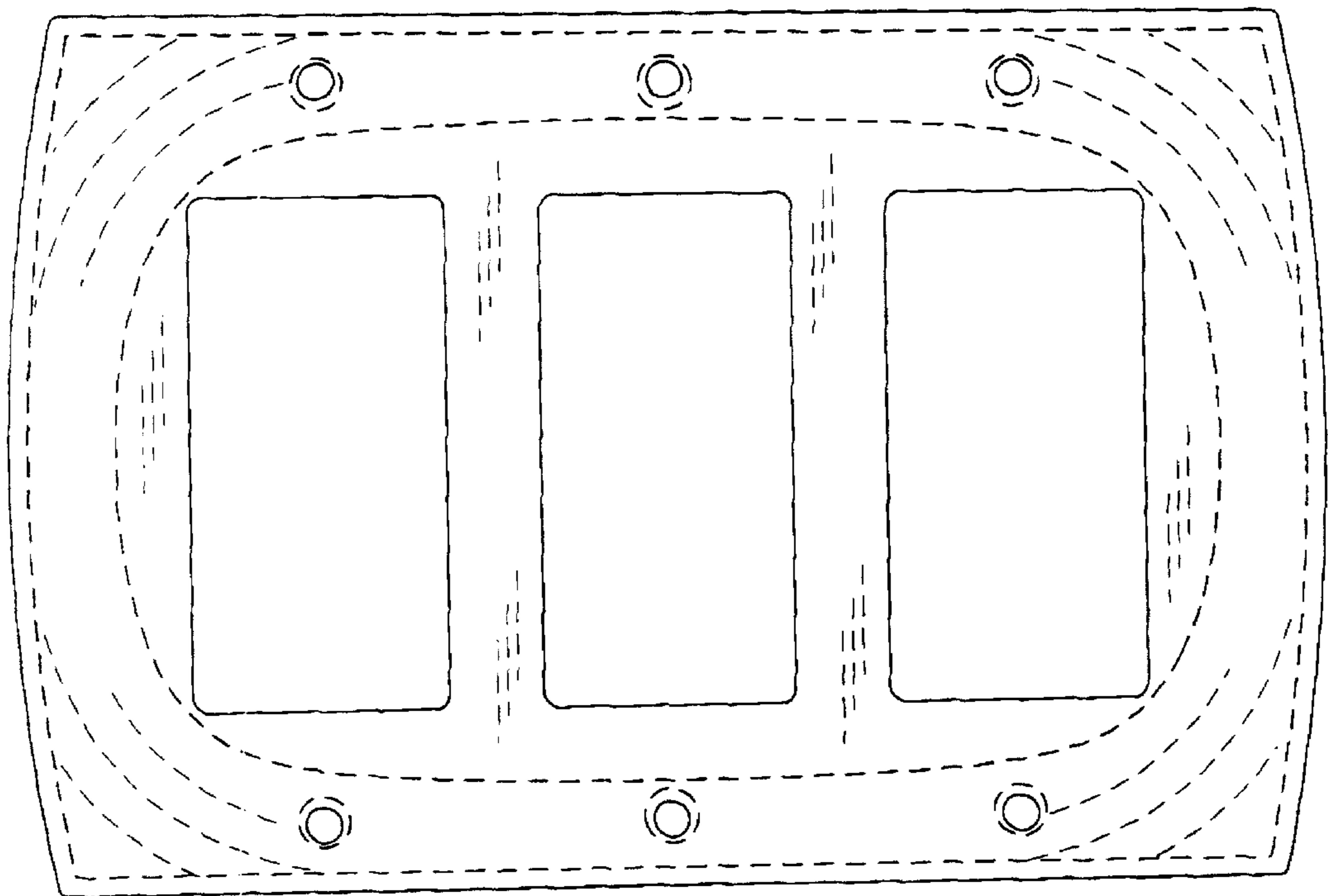

Fig. 38

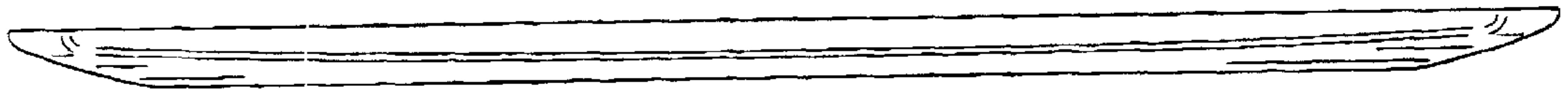

Fig. 39

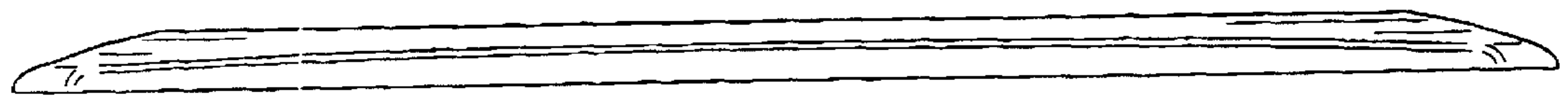

Fig. 40

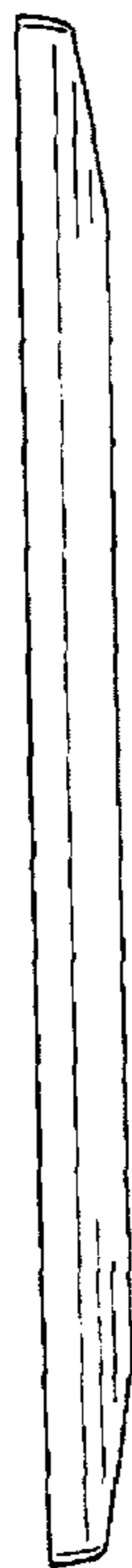

Fig. 41

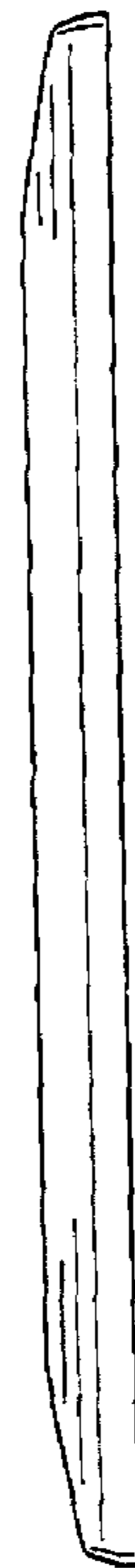

Fig. 42