



US00D476546S

(12) **United States Design Patent** (10) **Patent No.:** **US D476,546 S**  
**Ping** (45) **Date of Patent:** **\*\* Jul. 1, 2003**

(54) **FOLDABLE HAND TOOL**

**FOREIGN PATENT DOCUMENTS**

- (75) Inventor: **Qiu Jian Ping**, Hangzhou (CN)
- (73) Assignee: **Great Neck Saw Manufacturers, Inc.**, Mineola, NY (US)
- (\*\*) Term: **14 Years**
- (21) Appl. No.: **29/149,232**
- (22) Filed: **Oct. 5, 2001**

CH	277412	8/1951
DE	29556	4/1884
DE	30788	11/1884
DE	145784	7/1902
DE	2322229	5/1974
DE	G 91 03 496.5	8/1991
EP	97100156.5	7/1997
FR	409943	5/1910
FR	2308470	11/1976
GB	186520	10/1922
GB	403769	1/1934
GB	5375	4/2000
GB	13254	7/2000
GB	14268	8/2000
GB	15859	8/2000
GB	17248	8/2000
GB	20299	10/2000
GB	21369	10/2000
IT	521555	3/1955
RU	1002145	3/1983

**Related U.S. Application Data**

- (62) Division of application No. 29/124,955, filed on Jun. 15, 2000, now Pat. No. Des. 458,527.
- (51) **LOC (7) Cl.** ..... **08-05**
- (52) **U.S. Cl.** ..... **D8/107; D8/52**
- (58) **Field of Search** ..... D8/52, 55, 58, D8/104, 105, 107, 309, DIG. 7; D7/393, 395, 649; 81/177.1, 177.4, 177.6, 177.7, 178, 489; 16/110 R; 7/118, 125, 127, 128, 138, 165, 167, 168

*Primary Examiner*—Alan P. Douglas  
*Assistant Examiner*—Clare E. Heflin  
 (74) *Attorney, Agent, or Firm*—Joseph J. Previto

(56) **References Cited**

**U.S. PATENT DOCUMENTS**

154,750 A	9/1874	Flack
164,750 A	6/1875	Meyer
237,138 A	2/1881	Slayton
266,073 A	1/1882	Augstin
295,885 A	3/1884	Pullman
310,439 A	1/1885	Kamak
337,858 A	3/1886	Neuhaus
358,312 A	2/1887	Weck
445,509 A	1/1891	Thayer
464,405 A	12/1891	Widman
542,601 A	7/1895	Baker
580,235 A	4/1897	Strum
589,392 A	7/1897	Kolar
592,766 A	11/1897	Effinger et al.

(List continued on next page.)

(57) **CLAIM**

The ornamental design of a foldable hand tool, as shown and described.

**DESCRIPTION**

FIG. 1 is a plan view of a foldable hand tool showing my new design in the unfolded position.  
 FIG. 2 is a plan view showing the opposite side thereof.  
 FIG. 3 is a view taken along line 3—3 of FIG. 1.  
 FIG. 4 is a view taken along line 4—4 of FIG. 1.  
 FIG. 5 is a plan view of the foldable hand tool showing my new design in the folded position; and,  
 FIG. 6 is a plan view showing the opposite side thereof.  
 The broken lines shown on the drawings are for illustrative purposes only and form no part of the claimed design.

**1 Claim, 2 Drawing Sheets**

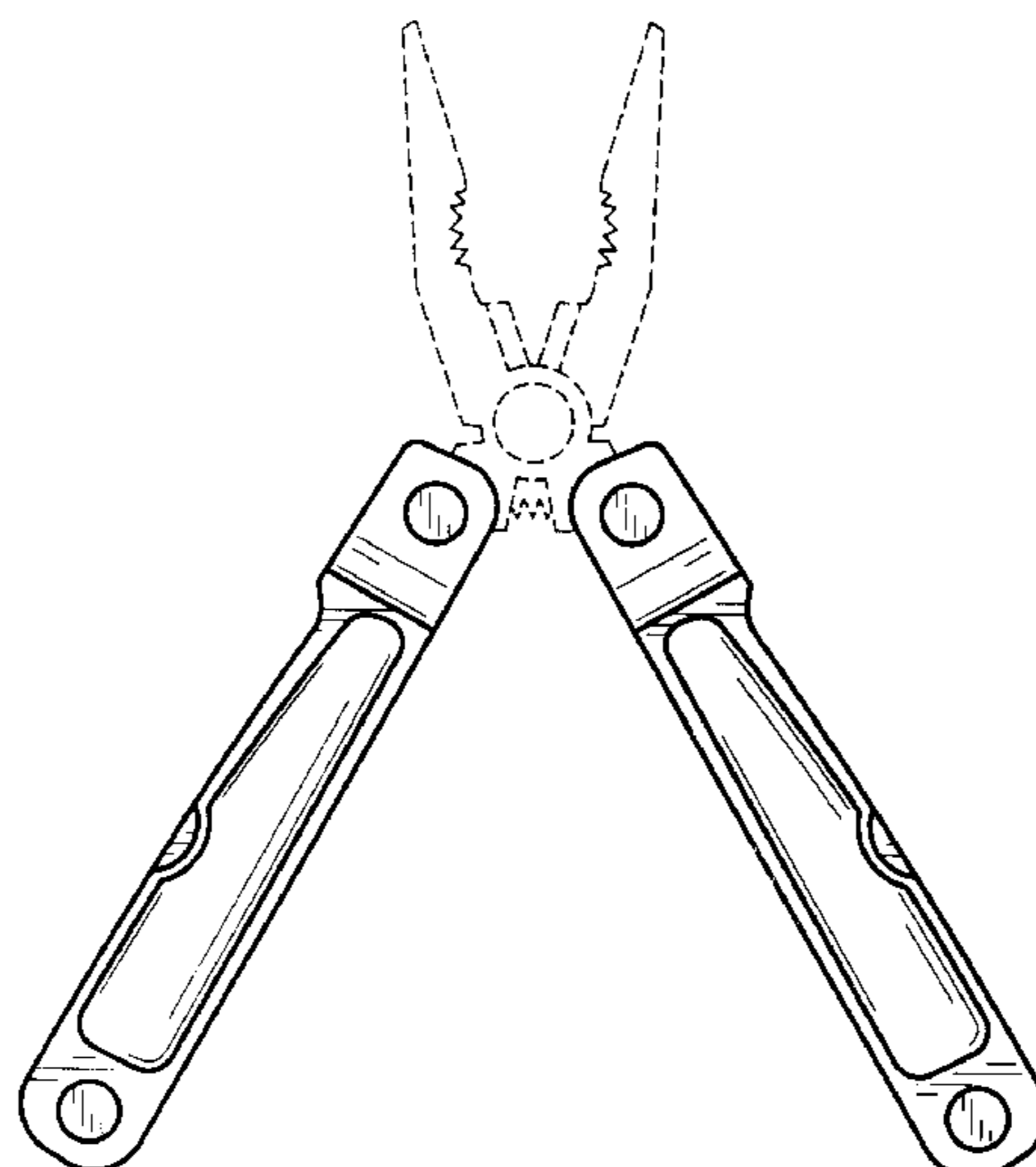

# US D476,546 S

Page 2

## U.S. PATENT DOCUMENTS

596,096 A	12/1897	Watts	4,555,822 A	12/1985	Miceli
614,537 A	11/1898	Dahlquist	4,563,833 A	1/1986	Aucoin
649,334 A	5/1900	Meloos	D286,501 S	11/1986	Magan
662,005 A	11/1900	Lewis	4,648,145 A	3/1987	Miceli
696,995 A	4/1902	Moser	4,669,140 A	6/1987	Miceli
762,725 A	6/1904	Kaufmann	4,744,272 A	5/1988	Leatherman
790,432 A	5/1905	Heilrath	4,805,303 A	2/1989	Gibbs
857,459 A	6/1907	Hendrickson	4,888,869 A	12/1989	Leatherman
858,003 A	6/1907	Klever	4,896,424 A	1/1990	Walker
881,294 A	3/1908	Billings	4,942,637 A	7/1990	Yeang-Yai
896,746 A	8/1908	McCarty	4,995,128 A	2/1991	Montgomery et al.
948,231 A	2/1910	Libby	5,014,379 A	5/1991	Hull et al.
988,068 A	3/1911	Beardsley et al.	5,029,355 A	7/1991	Thai
1,174,132 A	3/1916	Dragun	5,044,079 A	9/1991	Gibbs
1,184,746 A	5/1916	Hanson	5,062,173 A	11/1991	Collins et al.
1,187,842 A	6/1916	Kaas	5,074,046 A	12/1991	Kolesky
1,194,296 A	8/1916	Jones et al.	5,119,520 A	6/1992	Finn
1,334,425 A	3/1920	Wernimont	D327,826 S	7/1992	Neff
1,370,906 A	3/1921	Newton	5,142,721 A	9/1992	Sessiona et al.
1,461,270 A	7/1923	Garrison	5,157,996 A	10/1992	Keyvani
1,467,661 A	9/1923	Undy	5,207,012 A	5/1993	Lael
1,472,826 A	11/1923	Champlin	5,212,844 A	5/1993	Sessions et al.
1,474,592 A	11/1923	Jacoby	D338,386 S	8/1993	Frazer
1,486,725 A	3/1924	Brown	5,267,366 A	12/1993	Frazer
1,511,340 A	10/1924	Jackson	5,320,004 A	6/1994	Hsiao
1,524,694 A	2/1925	Di Maio	D356,019 S	3/1995	Sakai
1,551,328 A	8/1925	Perry	D365,266 S	12/1995	Hasegawa
1,561,833 A	11/1925	Cruickshank	5,491,856 A	2/1996	Legg
1,561,993 A	11/1925	Nielsen	D367,807 S	3/1996	Hung
1,619,181 A	3/1927	Beretz	5,497,522 A	3/1996	Chen
1,828,121 A	10/1931	Adam	D368,634 S	4/1996	Frazer
2,057,201 A	10/1936	McCluskey	D371,498 S	7/1996	Lai
D112,590 S	12/1938	MacPherson	5,537,750 A	7/1996	Seber et al.
D137,408 S	3/1944	Frisk	D382,182 S	8/1997	Seber et al.
D149,934 S	6/1948	Cobb	D384,872 S	10/1997	Yeh
2,514,130 A	7/1950	Jones	D385,170 S	10/1997	Rivera
2,561,682 A	7/1951	Barnett	5,697,114 A	12/1997	McIntosh et al.
2,575,652 A	11/1951	Bovee	5,745,997 A	5/1998	Berg et al.
2,606,471 A	8/1952	Kollweck	5,765,247 A	6/1998	Seber et al.
2,641,149 A	6/1953	Petersen	D407,286 S	3/1999	Seber et al.
2,714,249 A	8/1955	Clark et al.	D407,287 S	3/1999	Seber et al.
2,747,446 A	5/1956	Eder	D407,616 S	4/1999	Seber
2,779,098 A	1/1957	Pocoski et al.	D407,621 S	4/1999	Koon
2,814,108 A	11/1957	Bassett	D410,833 S	6/1999	Hasegawa
3,044,081 A	7/1962	Robinson, Jr.	D414,092 S	9/1999	Chang
3,364,508 A	1/1968	Garrett	5,964,131 A	10/1999	Seber et al.
3,798,687 A	3/1974	Stevens	D416,184 S	* 11/1999	Gathmann ..... D8/107
3,858,258 A	1/1975	Stevens	D416,186 S	11/1999	Balolia
3,947,905 A	4/1976	Neff	5,979,059 A	11/1999	Leatherman
4,208,749 A	6/1980	Hermann et al.	5,979,959 A	11/1999	Rivera
4,238,862 A	12/1980	Leatherman	D417,380 S	12/1999	Kayson
4,297,756 A	11/1981	Lance	5,996,451 A	12/1999	Seber et al.
4,330,937 A	5/1982	Cope	6,006,385 A	12/1999	Kershaw et al.
4,347,665 A	9/1982	Glessner	D419,849 S	2/2000	Kayson
4,364,174 A	12/1982	De Asis	6,047,426 A	4/2000	McIntosh et al.
4,502,220 A	3/1985	Aoki	D440,846 S	4/2001	Saunders
4,512,051 A	4/1985	Magan	D442,841 S	5/2001	Balolia

\* cited by examiner

FIG. 1

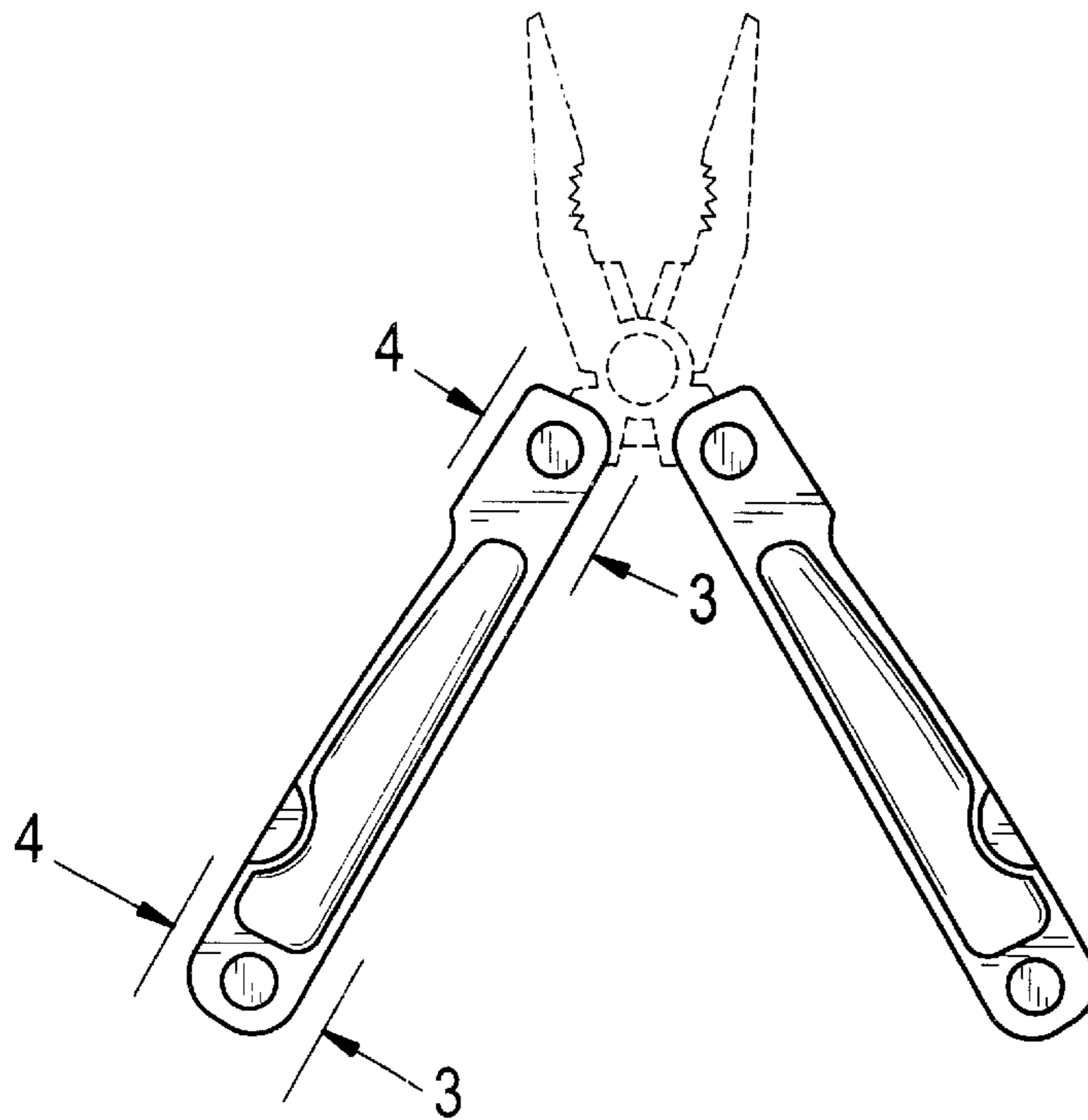

FIG. 3

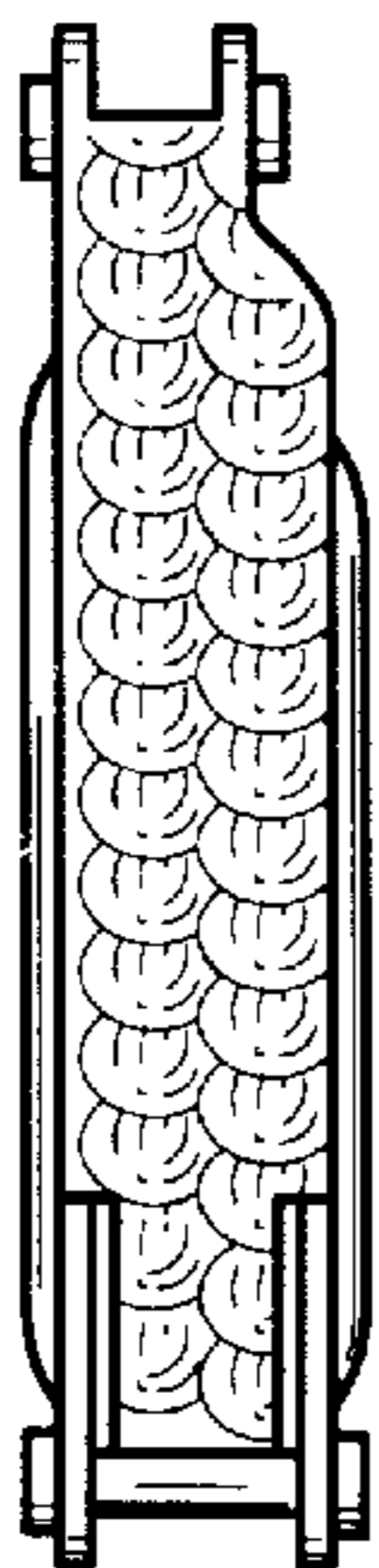

FIG. 2

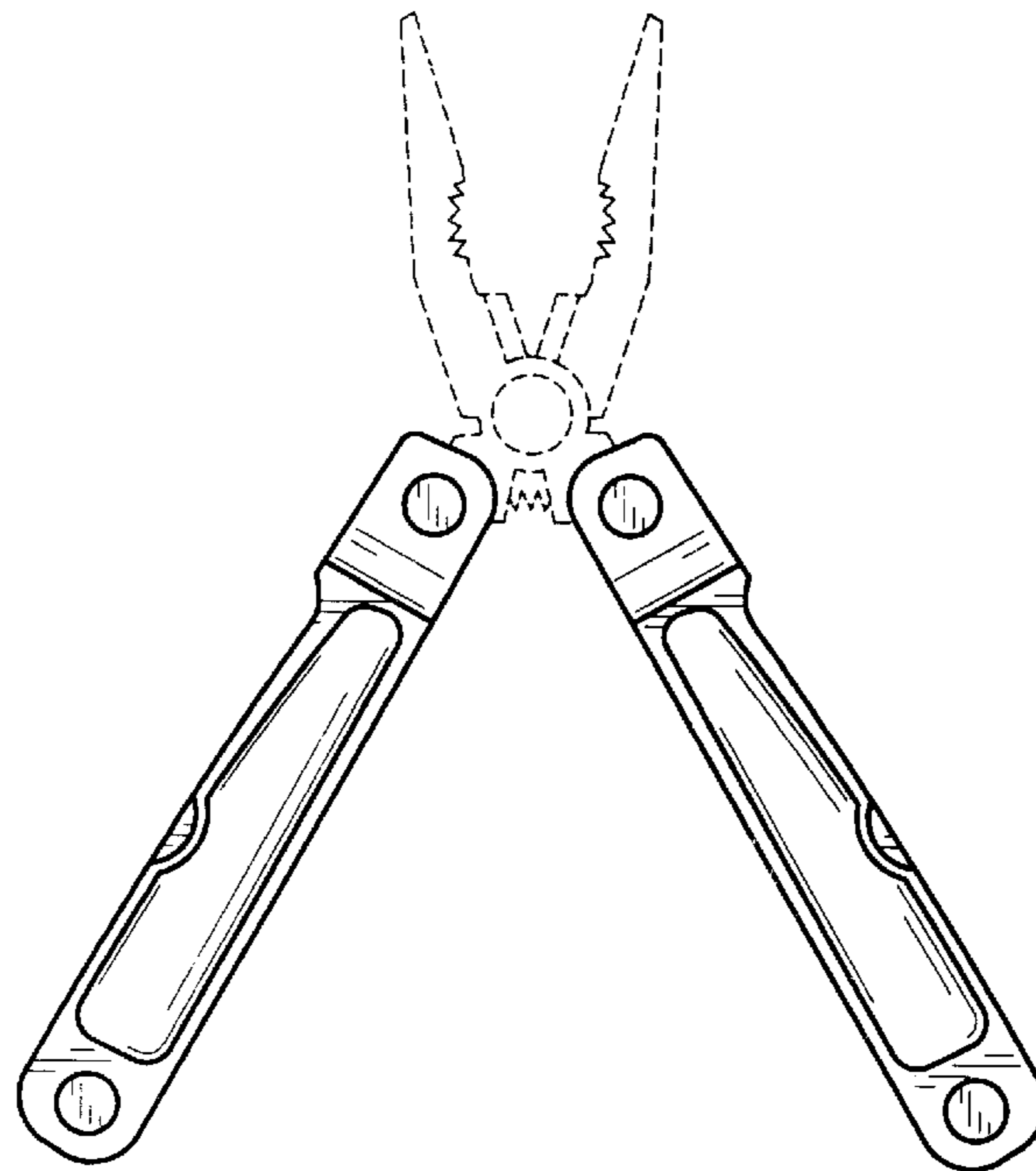
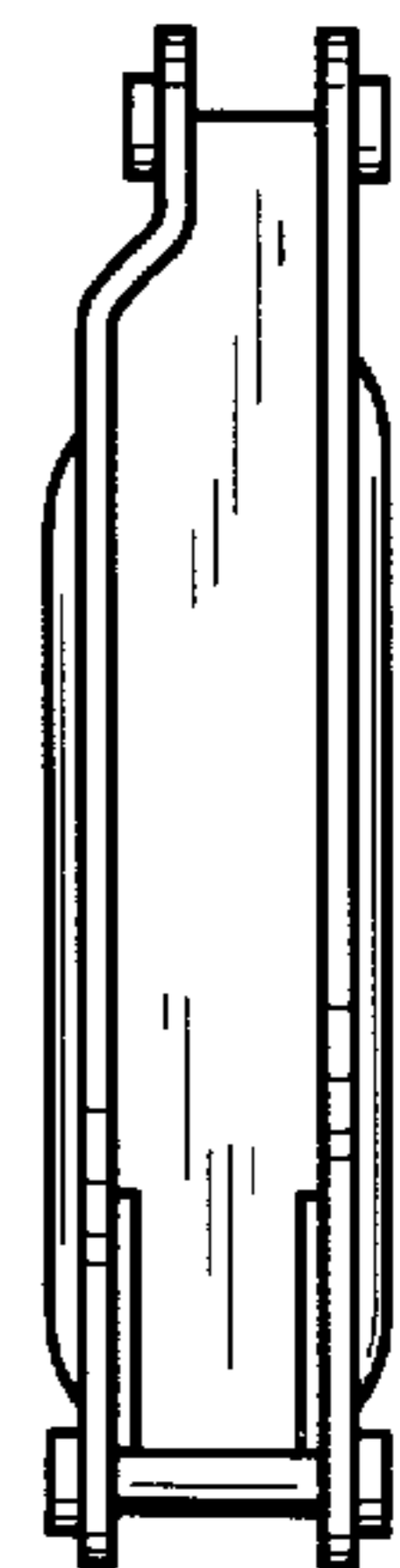

FIG. 4



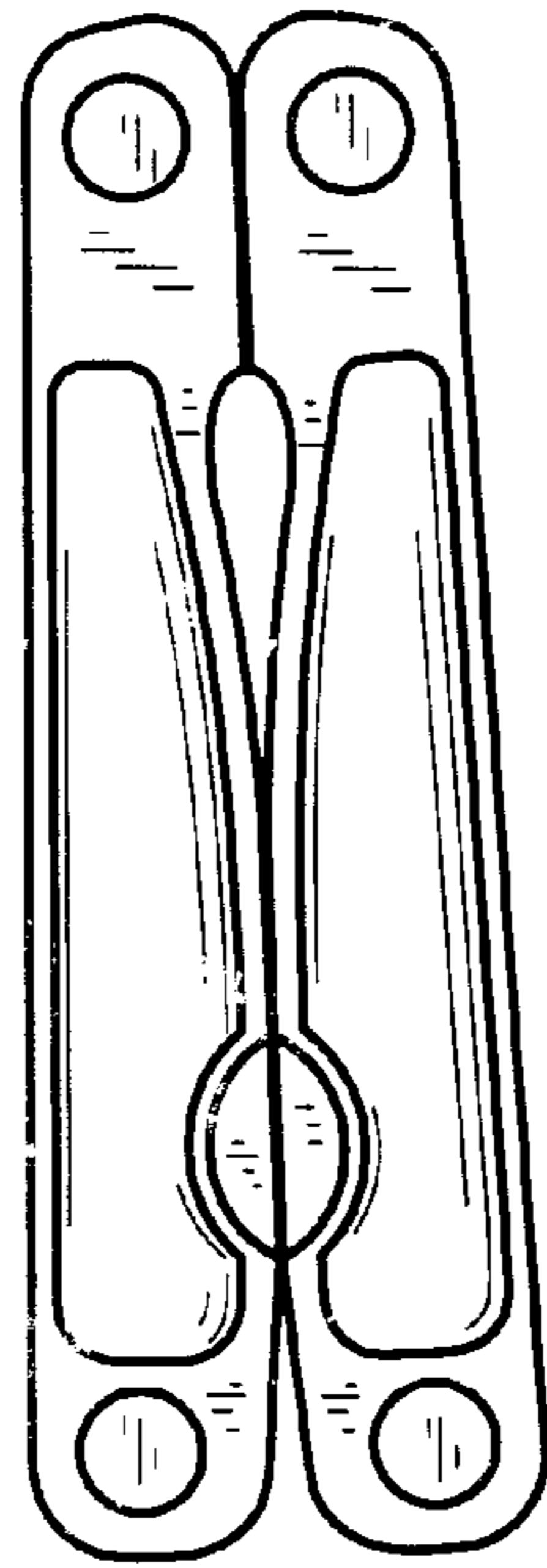

FIG. 5

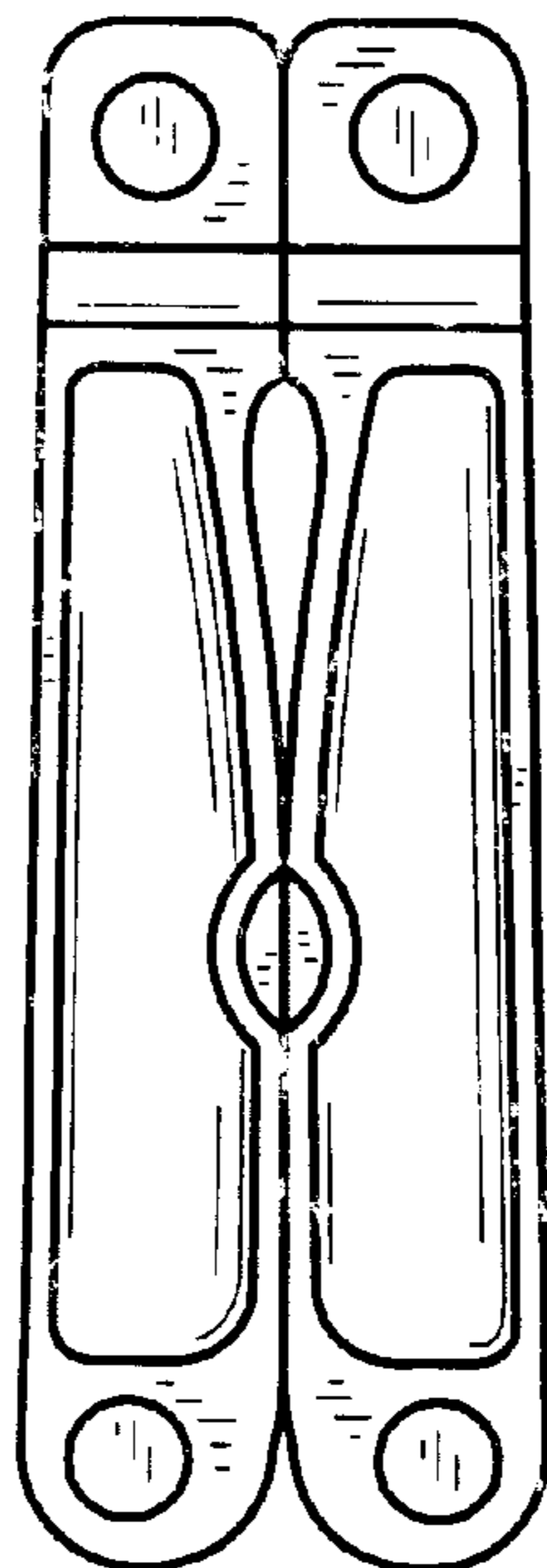

FIG. 6