



US00D476532S

(12) **United States Design Patent**
Edwards

(10) **Patent No.:** **US D476,532 S**

(45) **Date of Patent:** **** Jul. 1, 2003**

(54) **ICE CONTAINER**

(76) Inventor: **Richard Edwards**, 15391 Electronic
La., Huntington Beach, CA (US) 92649

(**) Term: **14 Years**

(21) Appl. No.: **29/161,804**

(22) Filed: **Jun. 4, 2002**

(51) **LOC (7) Cl.** **07-01**

(52) **U.S. Cl.** **D7/603**

(58) **Field of Search** D7/603-608, 612-615,
D7/629; D3/201; D32/53-54; D34/39; 62/457.1-457.8,
371, 372; 206/216, 223, 541, 545-549;
220/592.2, 592.24-592.27, 915.1, 915.2

(56) **References Cited**

U.S. PATENT DOCUMENTS

D12,831 S	*	3/1882	Meyer	D7/604
585,259 A	*	6/1897	Danz, II	206/546
4,537,044 A	*	8/1985	Putnam	62/371
D340,386 S	*	10/1993	McGourthy, Sr.	D7/603

* cited by examiner

Primary Examiner—Terry A. Wallace

(74) *Attorney, Agent, or Firm*—Stetina Brunda Garred &
Brucker

(57) **CLAIM**

The ornamental design for a ice container, as shown and
described.

DESCRIPTION

FIG. 1 is a top plan view of the ice container of the present
invention showing my new designs;

FIG. 2 is a front elevational view thereof;

FIG. 3 is a right side elevational view thereof;

FIG. 4 is a bottom plan view thereof;

FIG. 5 is a rear elevational view thereof; and,

FIG. 6 is an inverted side elevational view thereof depicting
the ice container in a stowed orientation with the phantom
lines depicting solely environmental structure forming no
part of the claim design.

1 Claim, 2 Drawing Sheets

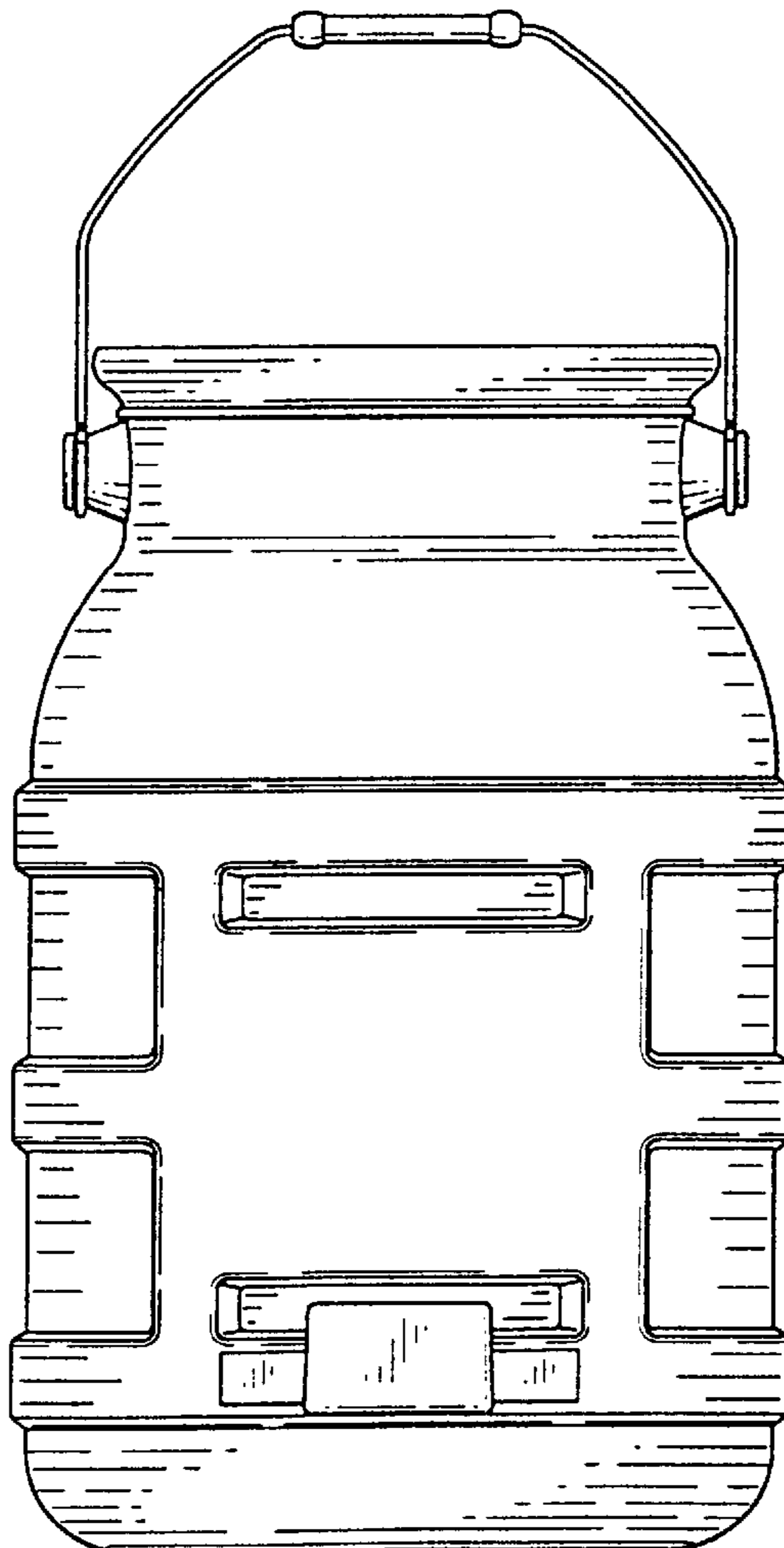

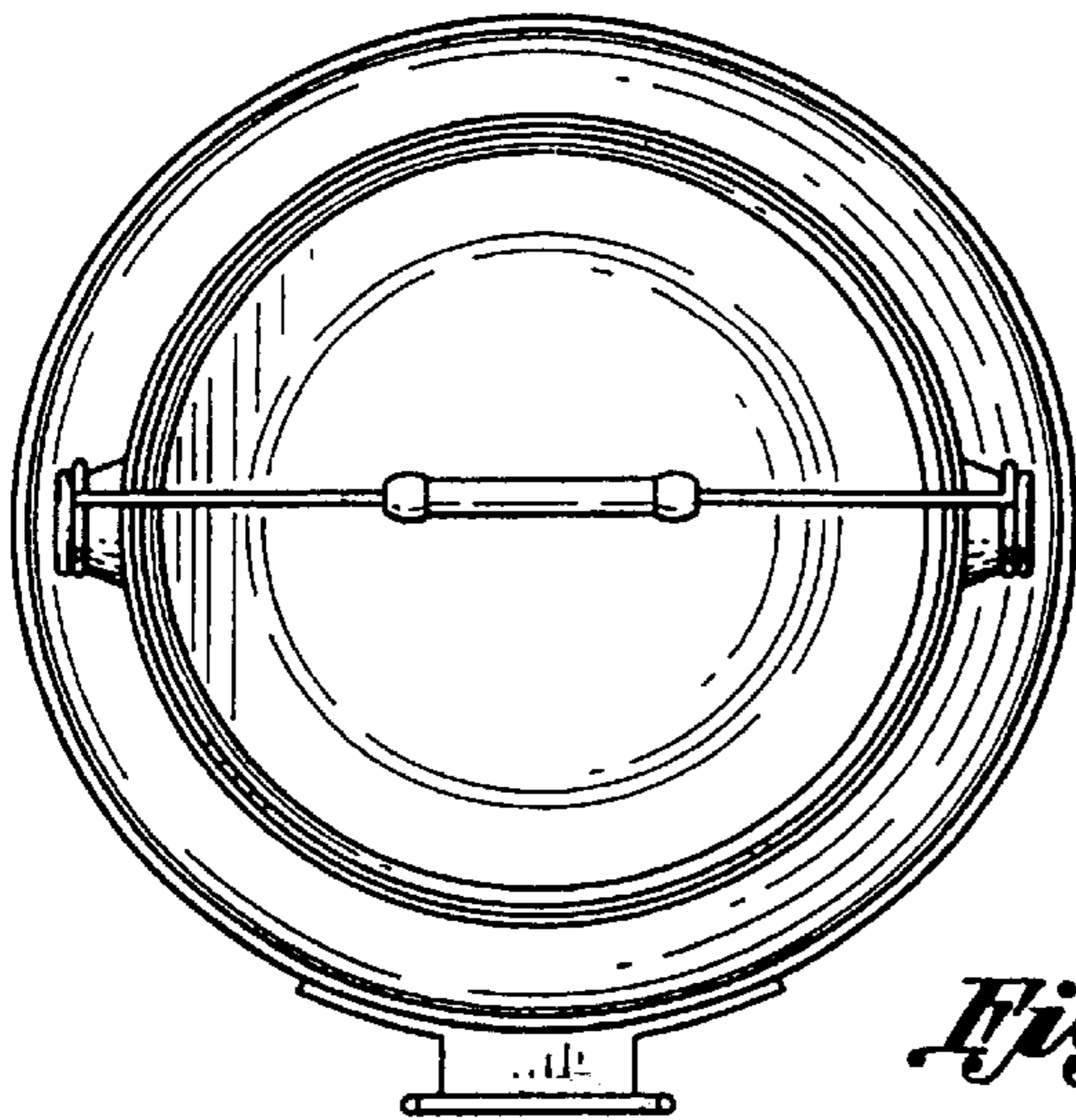

Fig. 1

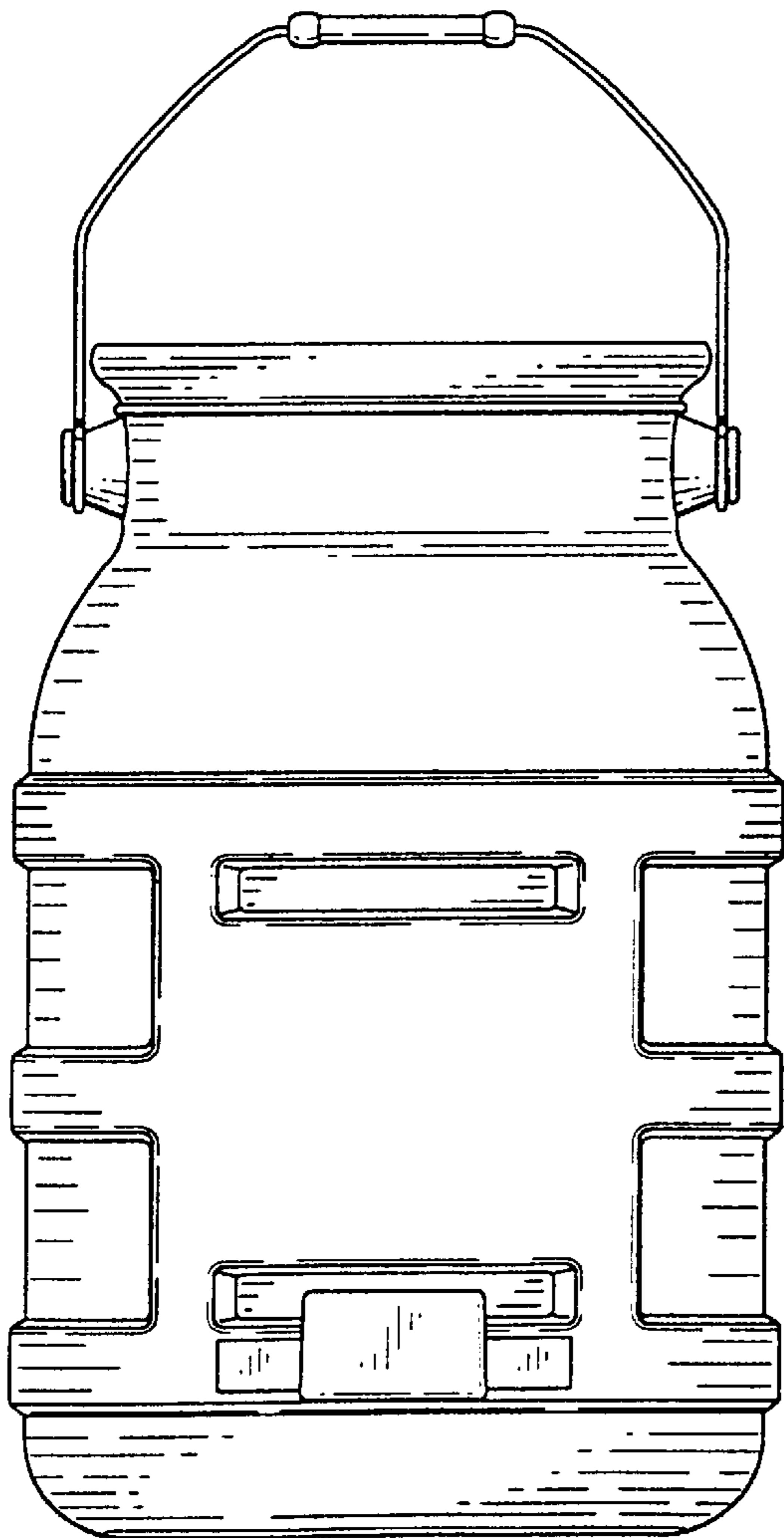

Fig. 2

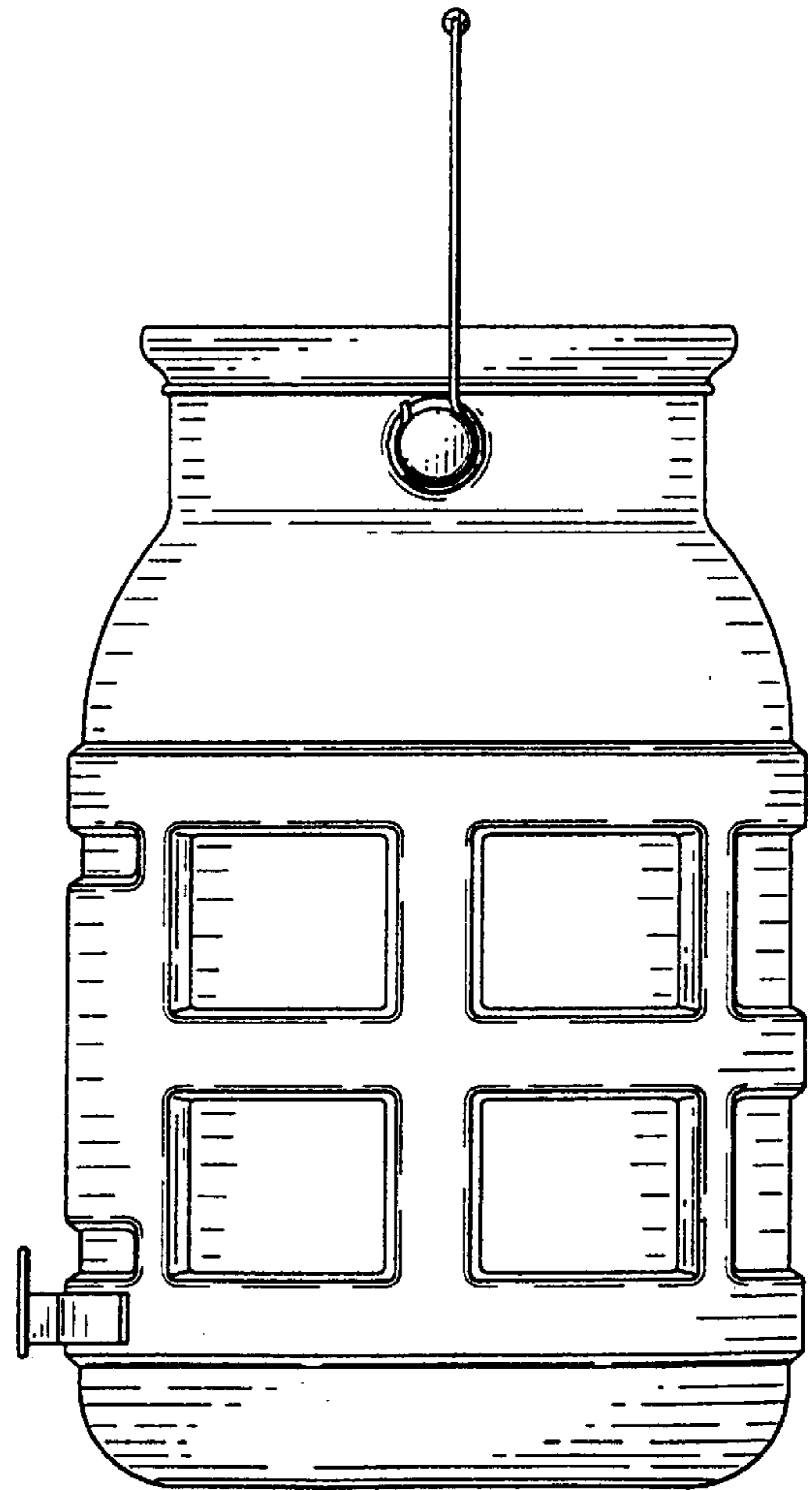

Fig. 3

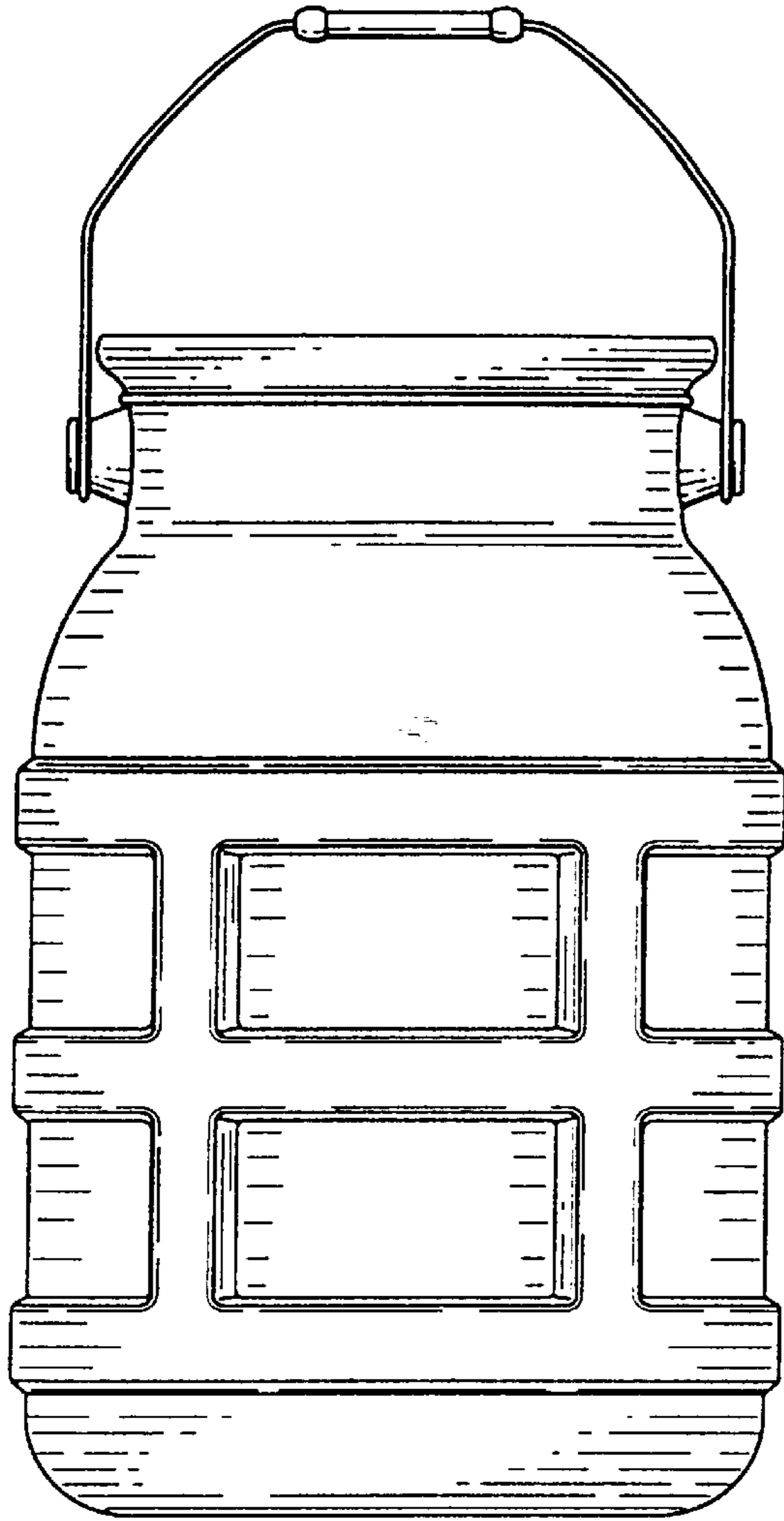

Fig. 5

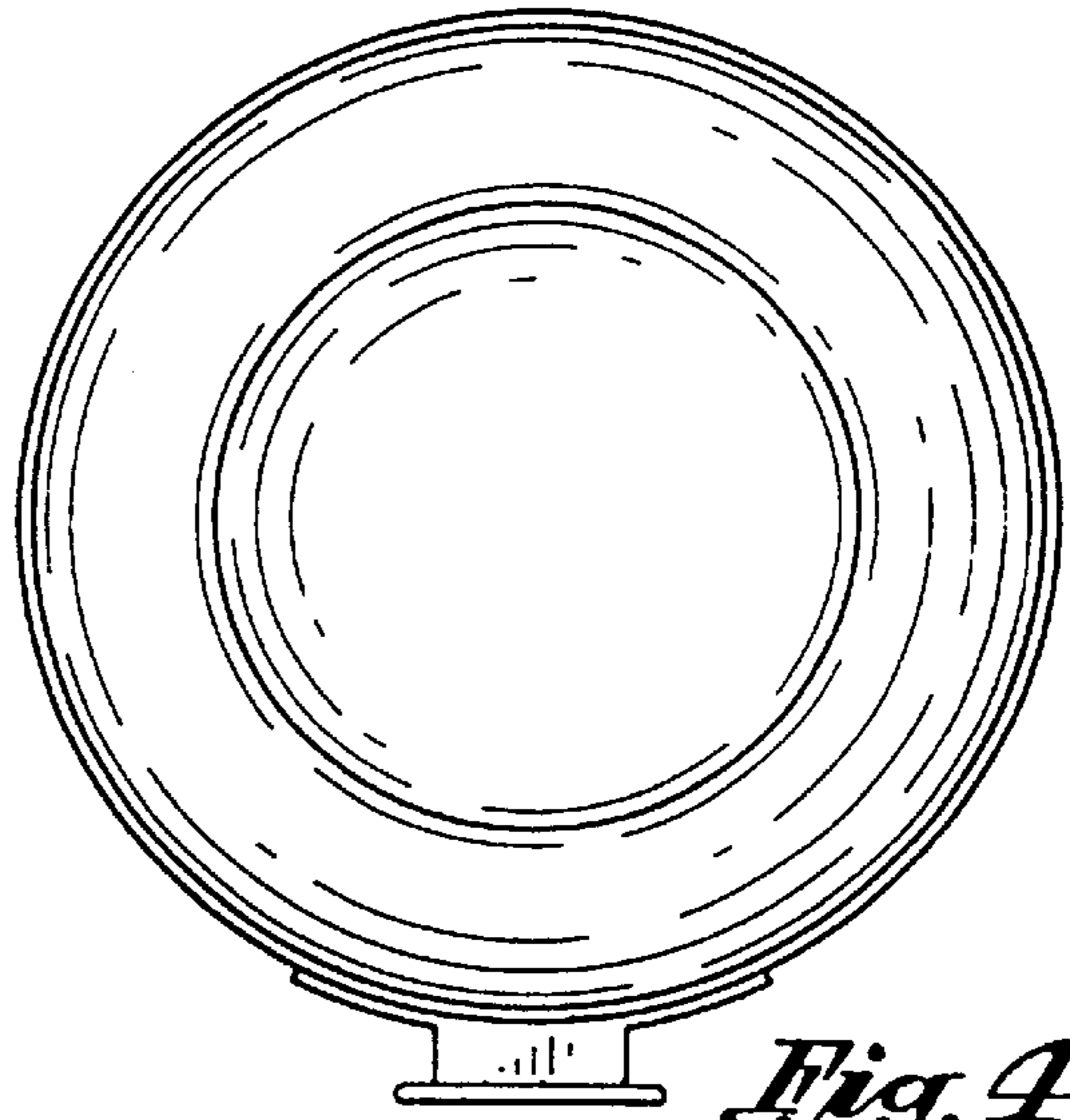

Fig. 4

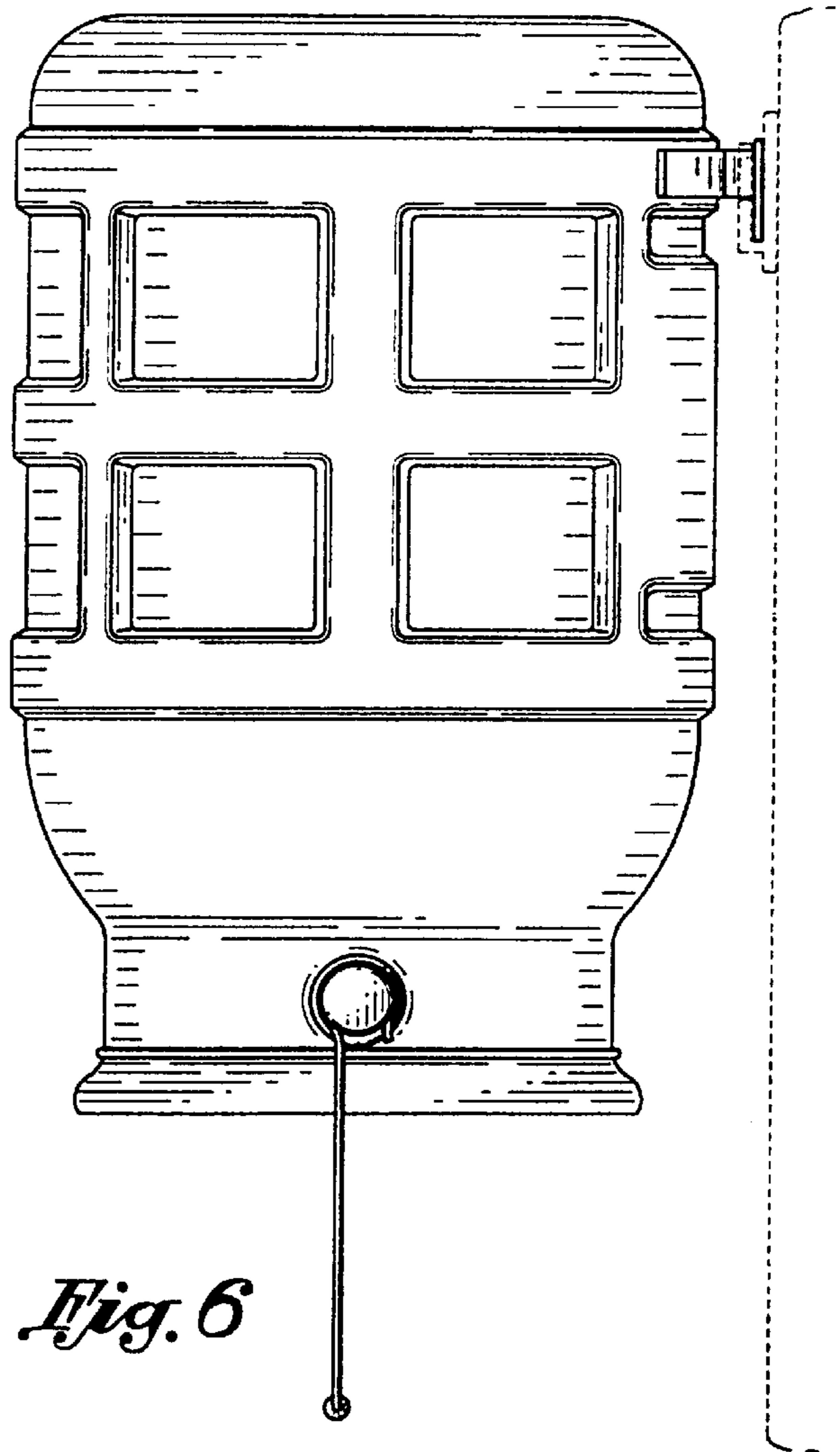

Fig. 6