



US00D476485S

(12) **United States Design Patent**  
**Mulder et al.**

(10) **Patent No.:** **US D476,485 S**

(45) **Date of Patent:** **\*\* Jul. 1, 2003**

(54) **ELECTRIC TOOTHBRUSH**

(76) Inventors: **Boyd William Franciscus Mulder**,  
5602 Lakeview Dr., Apt. #B, Kirkland,  
WA (US) 98033; **Andreas Loibnegger**,  
11000 NE. 10<sup>th</sup> St., Apt. #234,  
Bellevue, WA (US) 98004; **Jamie Mc  
Currach**, Visserstraat 26A, Groningen  
(NL), 9712CW; **Marc William  
Bommarito**, 12610 SE. 105<sup>th</sup> Pl.,  
Renton, WA (US) 98056

(\*\*) Term: **14 Years**

(21) Appl. No.: **29/159,933**

(22) Filed: **Apr. 30, 2002**

(51) **LOC (7) Cl.** ..... **04-02**

(52) **U.S. Cl.** ..... **D4/101**

(58) **Field of Search** ..... D4/101, 104-112;  
15/167.1, 143.1, 22.1, 105-106

(56) **References Cited**

**U.S. PATENT DOCUMENTS**

D334,473 S \* 4/1993 Volpenhein et al. .... D4/104  
5,383,242 A \* 1/1995 Bigler et al. .... 15/22.1  
5,504,959 A \* 4/1996 Yukawa et al. .... 15/22.1  
5,511,275 A \* 4/1996 Volpenhein et al. .... 15/167.1

5,727,273 A \* 3/1998 Pai ..... 15/22.1  
D400,713 S \* 11/1998 Solanki ..... D4/104  
D440,767 S \* 4/2001 Moskovich et al. .... D4/104  
D458,028 S \* 6/2002 McCurrach ..... D4/101

\* cited by examiner

*Primary Examiner*—Holly Baynham

(74) *Attorney, Agent, or Firm*—Ernestine C. Bartlett

(57) **CLAIM**

The ornamental design for a electric toothbrush, as shown.

**DESCRIPTION**

FIG. 1 is a perspective view of an assembled toothbrush;  
FIG. 2 is a front view thereof;  
FIG. 3 is a rear view thereof;  
FIG. 4 is a left side view thereof;  
FIG. 5 is a top view thereof;  
FIG. 6 is a bottom view thereof;  
FIG. 7 is a perspective view of a disassembled toothbrush;  
FIG. 8 is a front view of head and body disassembled;  
FIG. 9 is a back view of head and body disassembled;  
FIG. 10 is a left view of head and body disassembled;  
FIG. 11 is a right side view of head and body disassembled;  
FIG. 12 is a top view of head and body disassembled; and  
FIG. 13 is a bottom view of head and body disassembled.

**1 Claim, 11 Drawing Sheets**

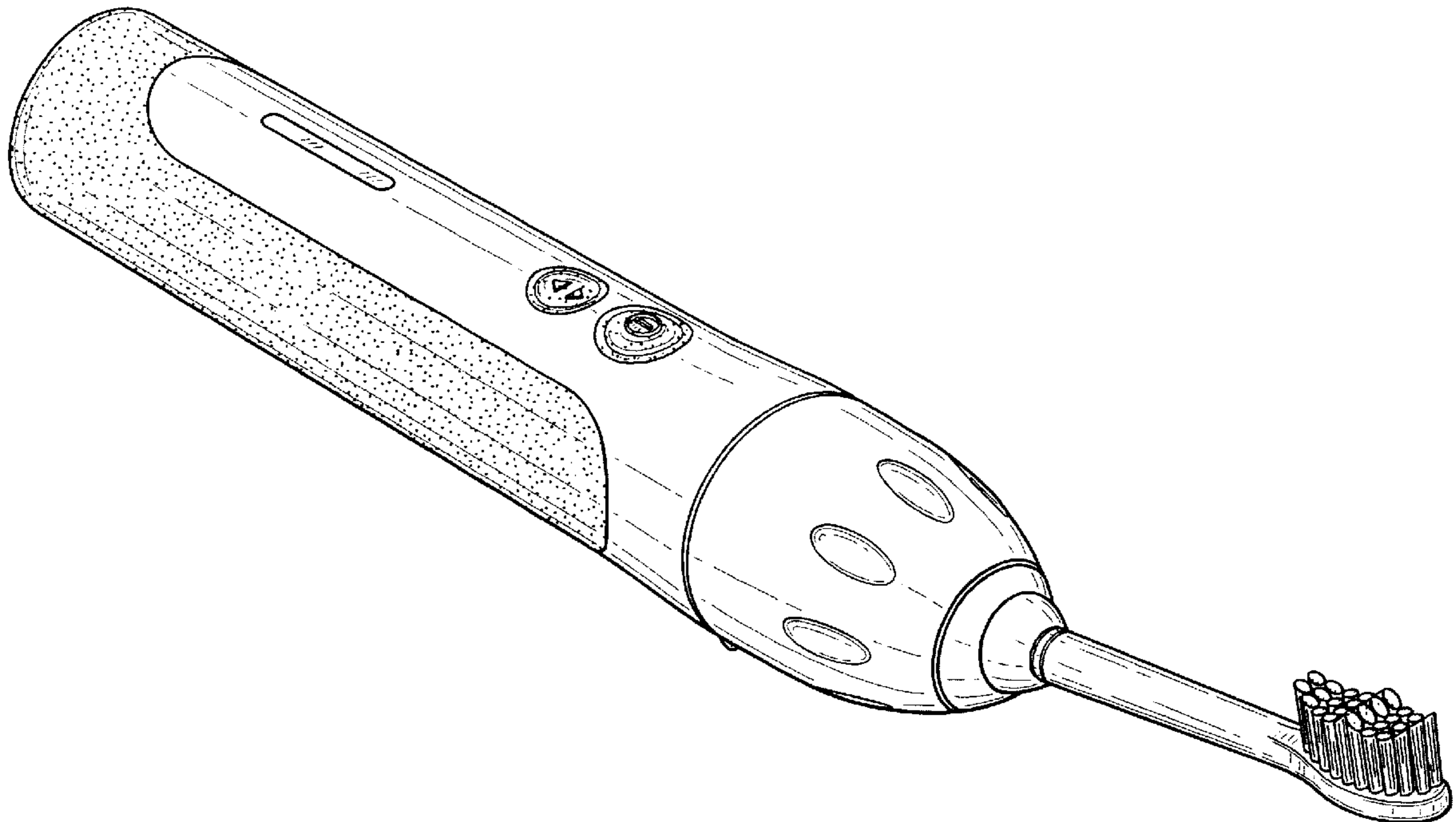

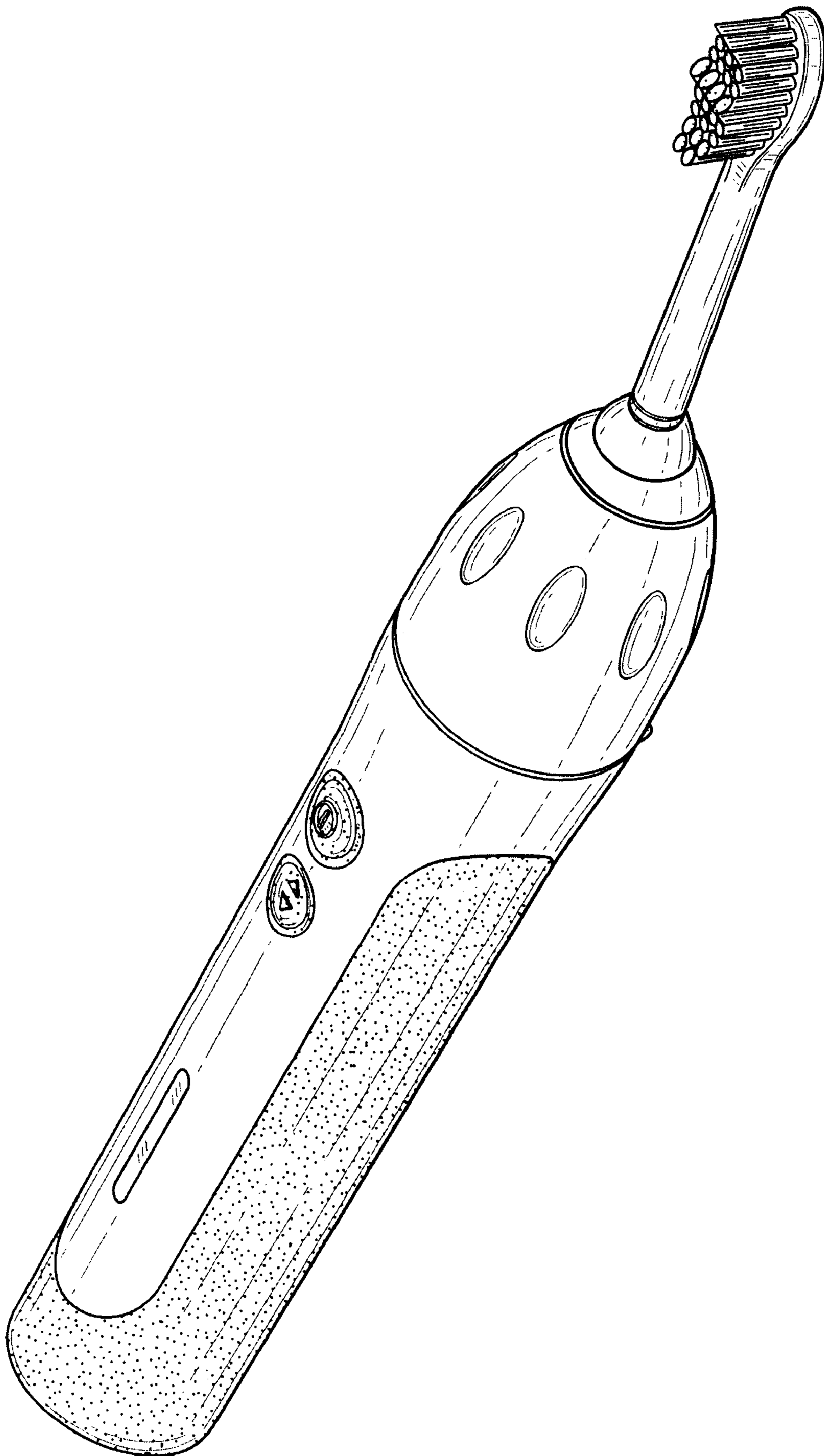

FIG. 1

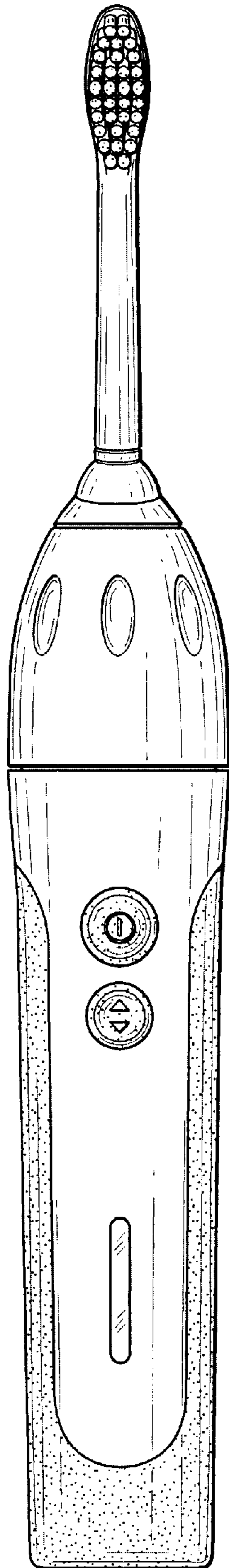

FIG. 2

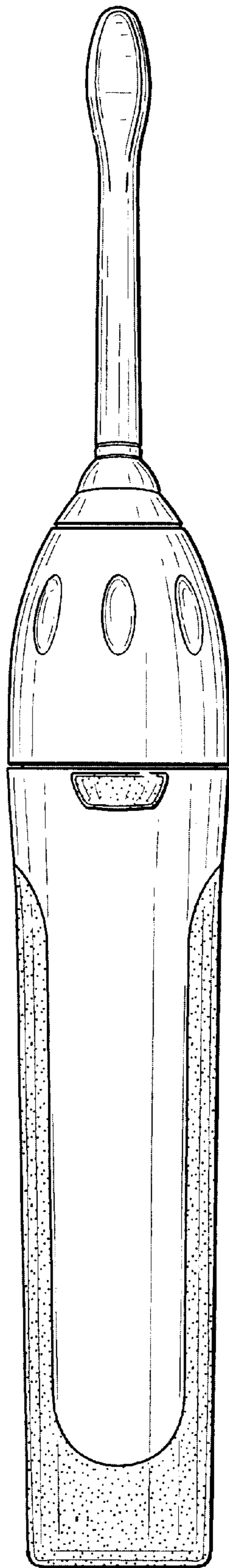

FIG. 3

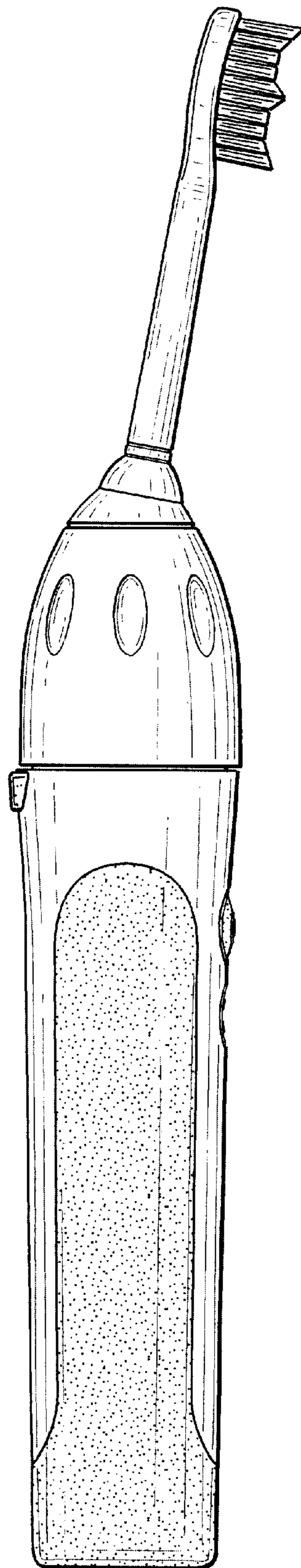

FIG. 4



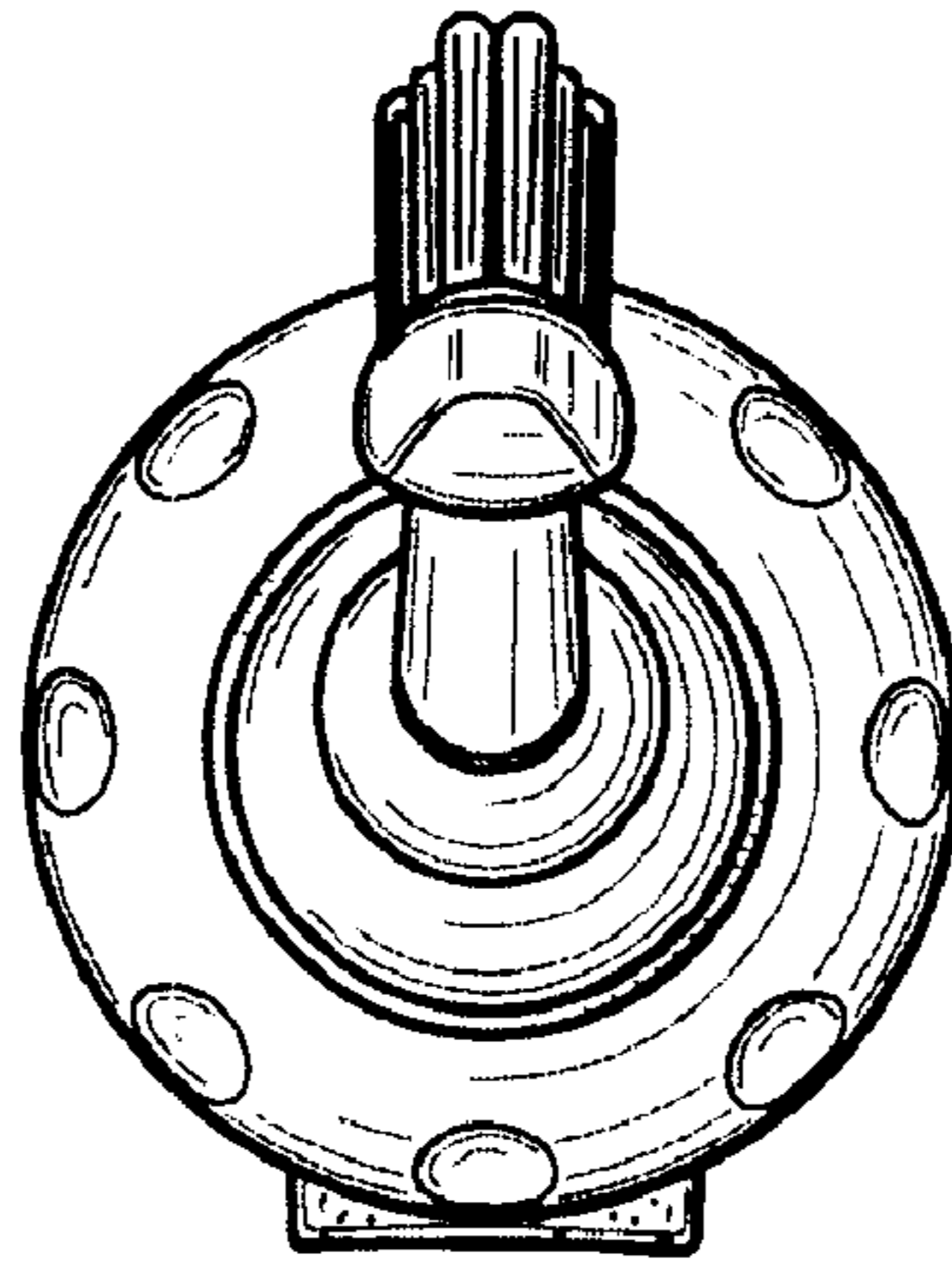

FIG. 5

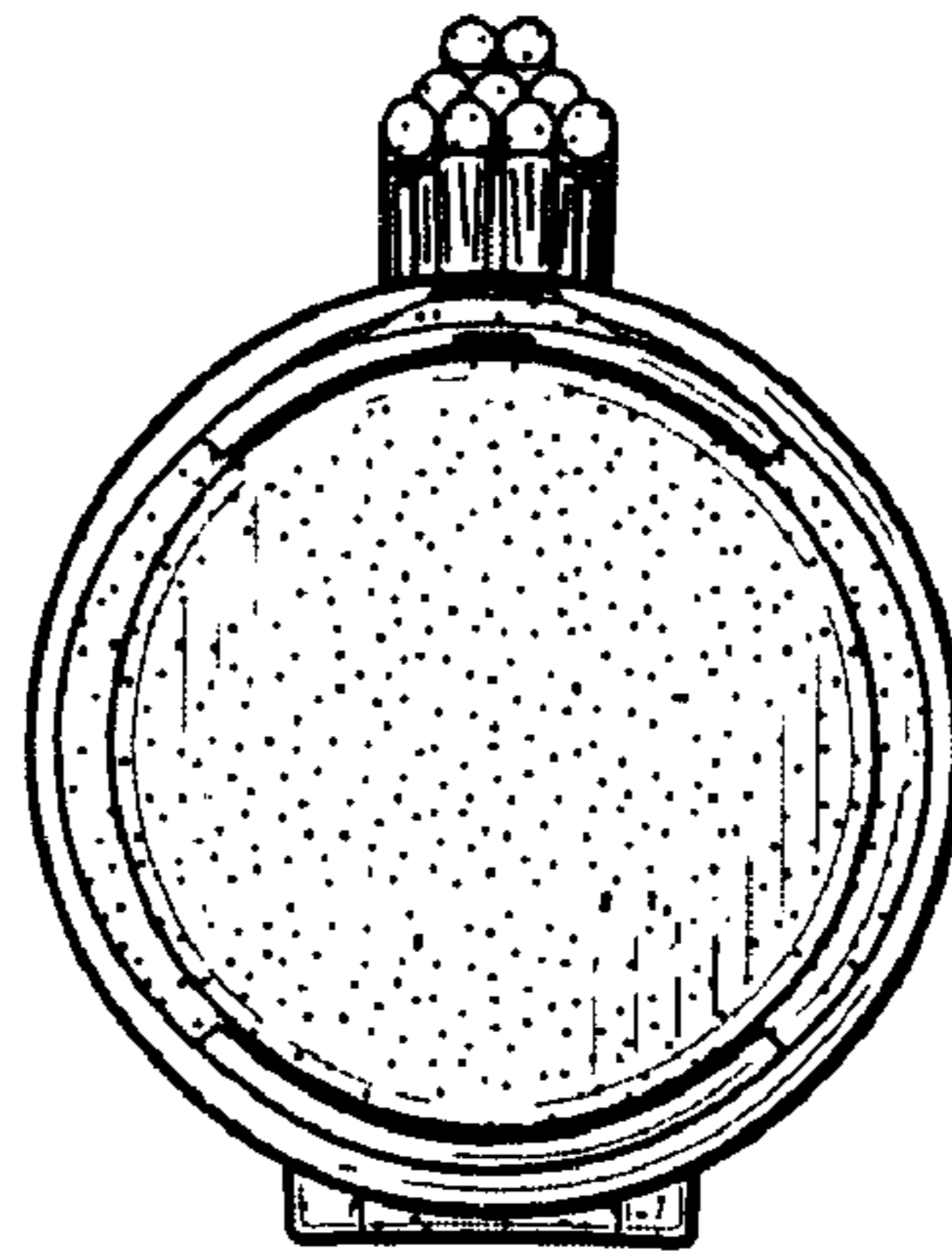

FIG. 6

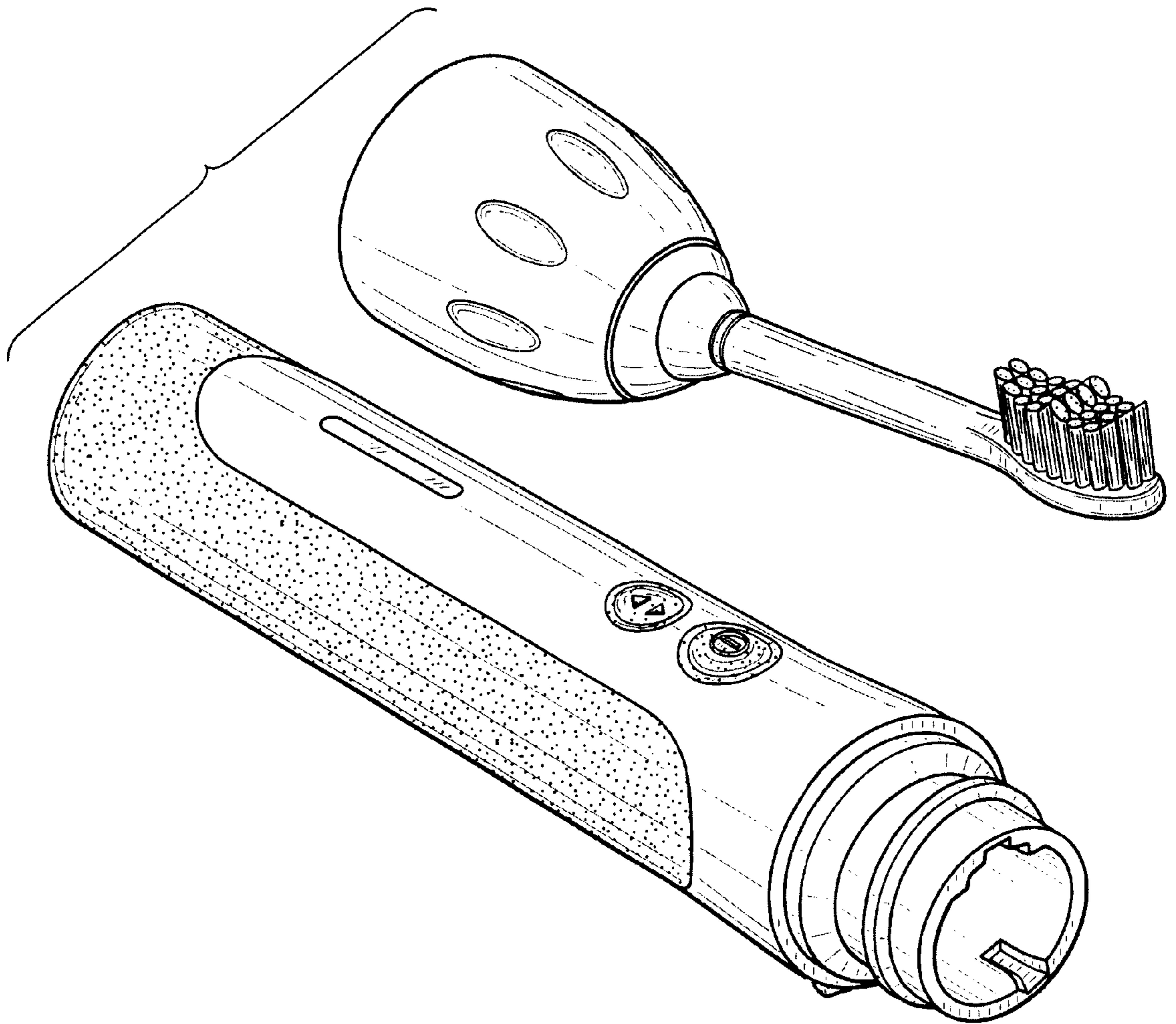

FIG. 7

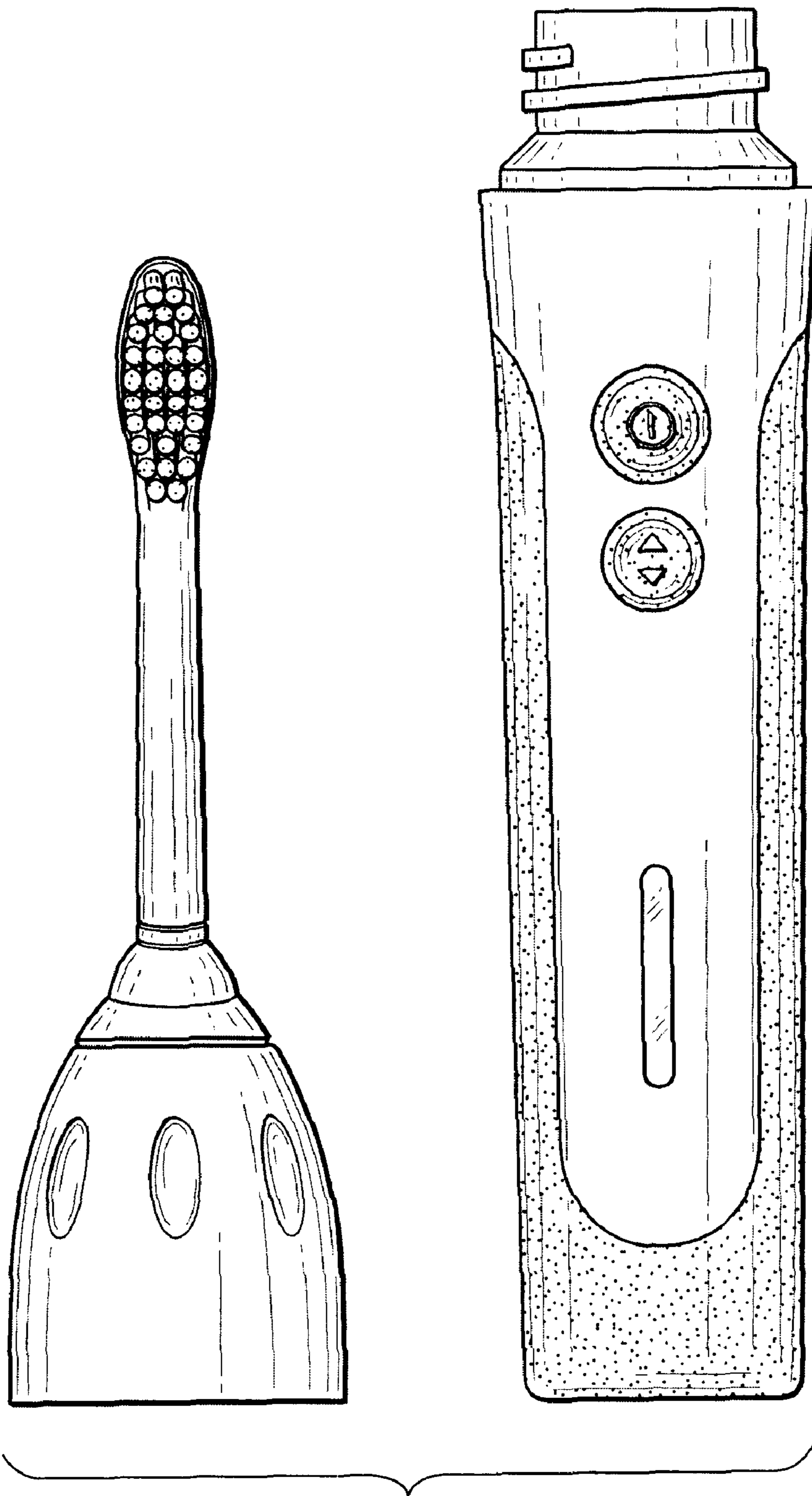

FIG. 8



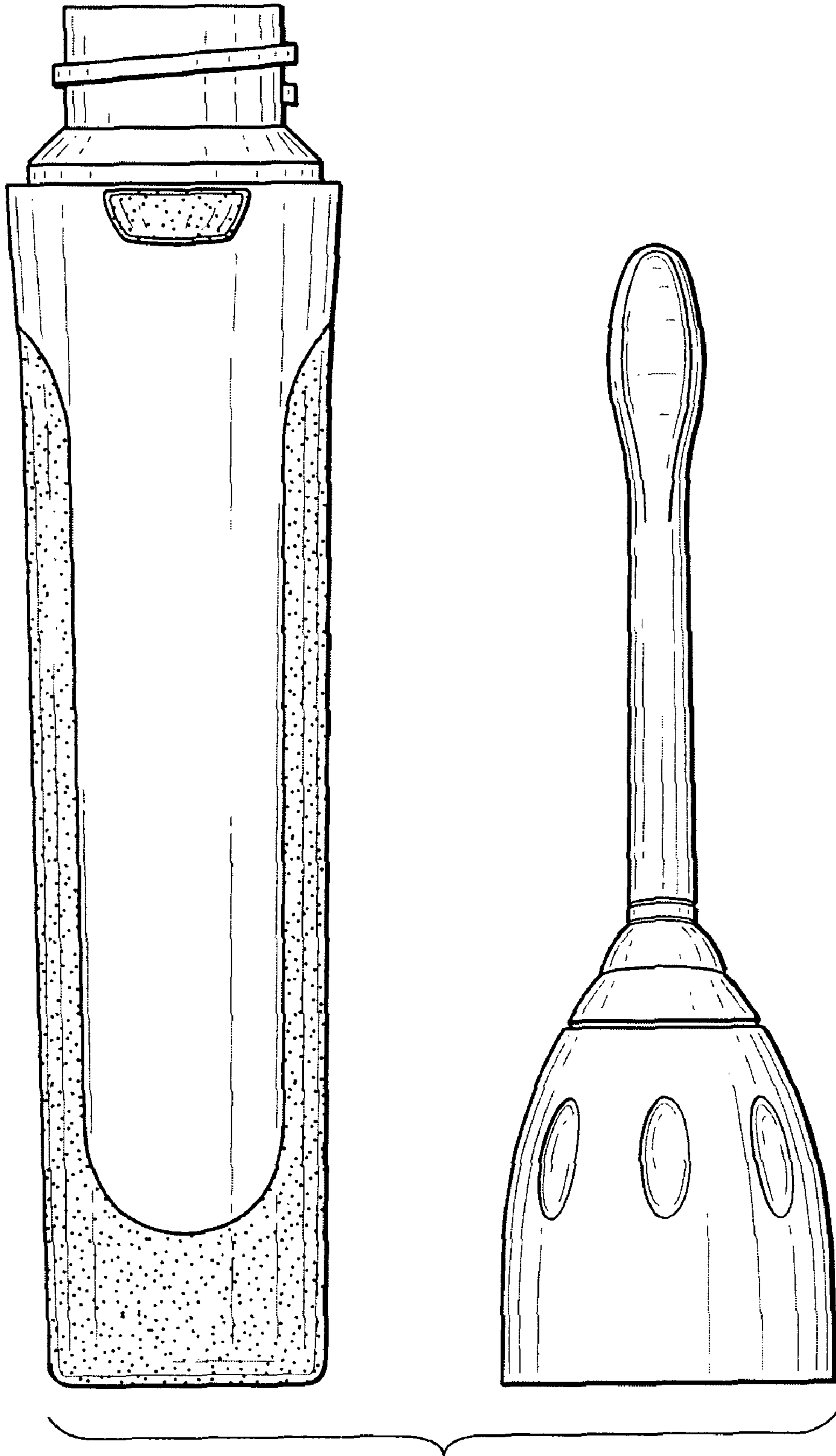

FIG. 9

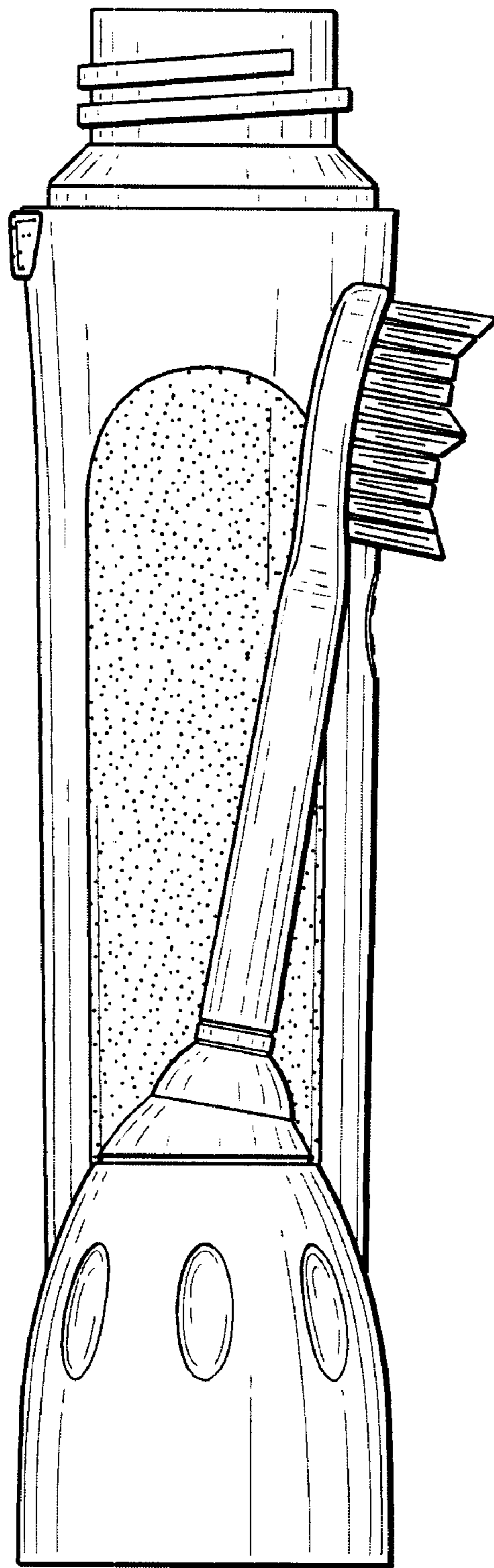

FIG. 10

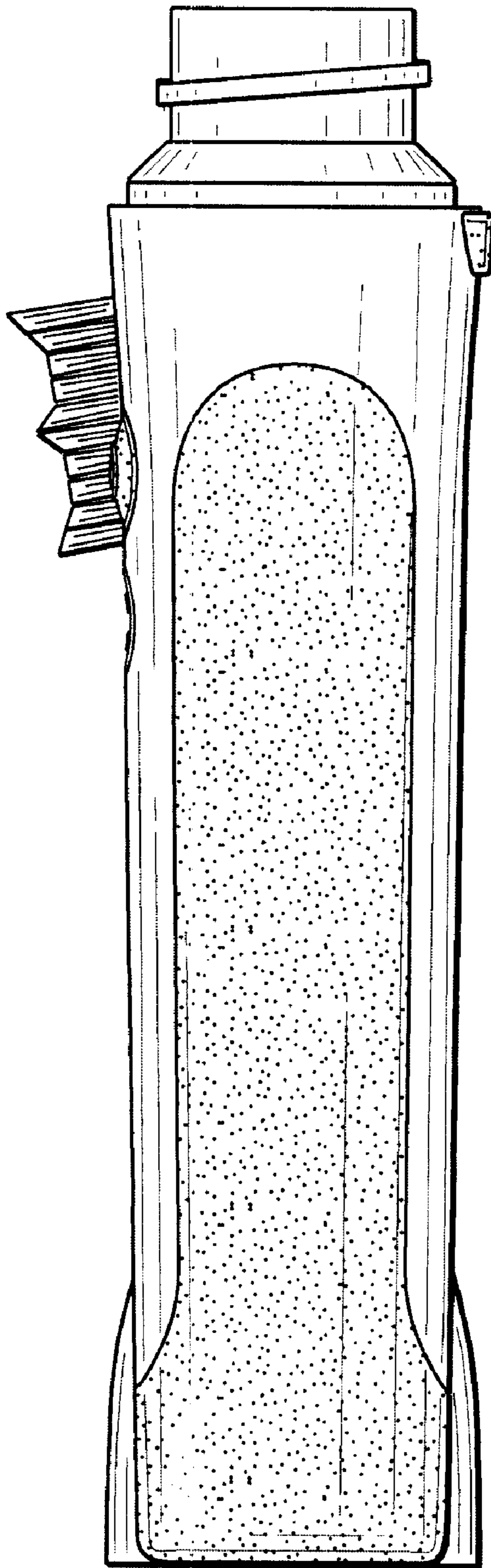

FIG. 11

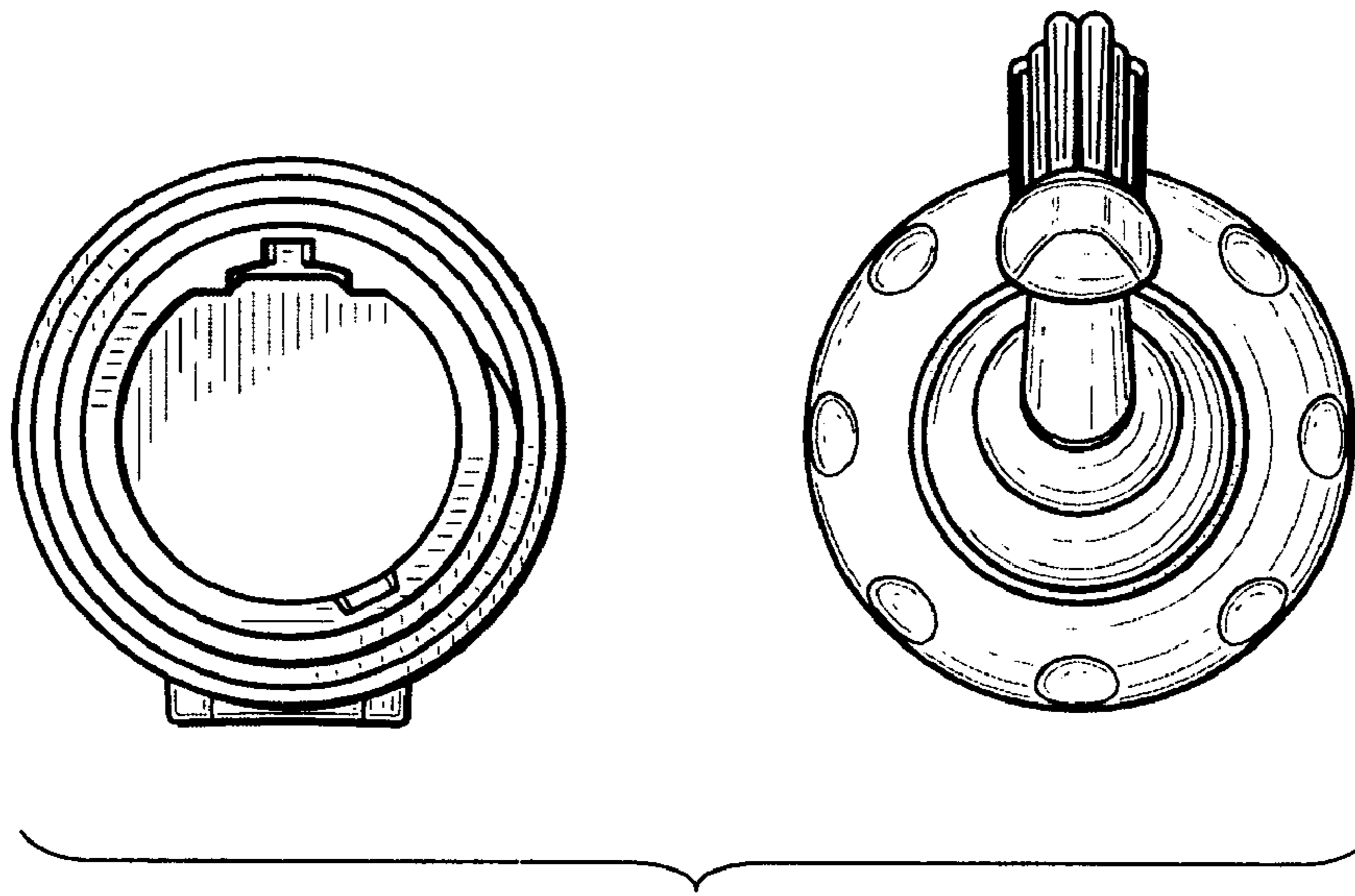

FIG. 12

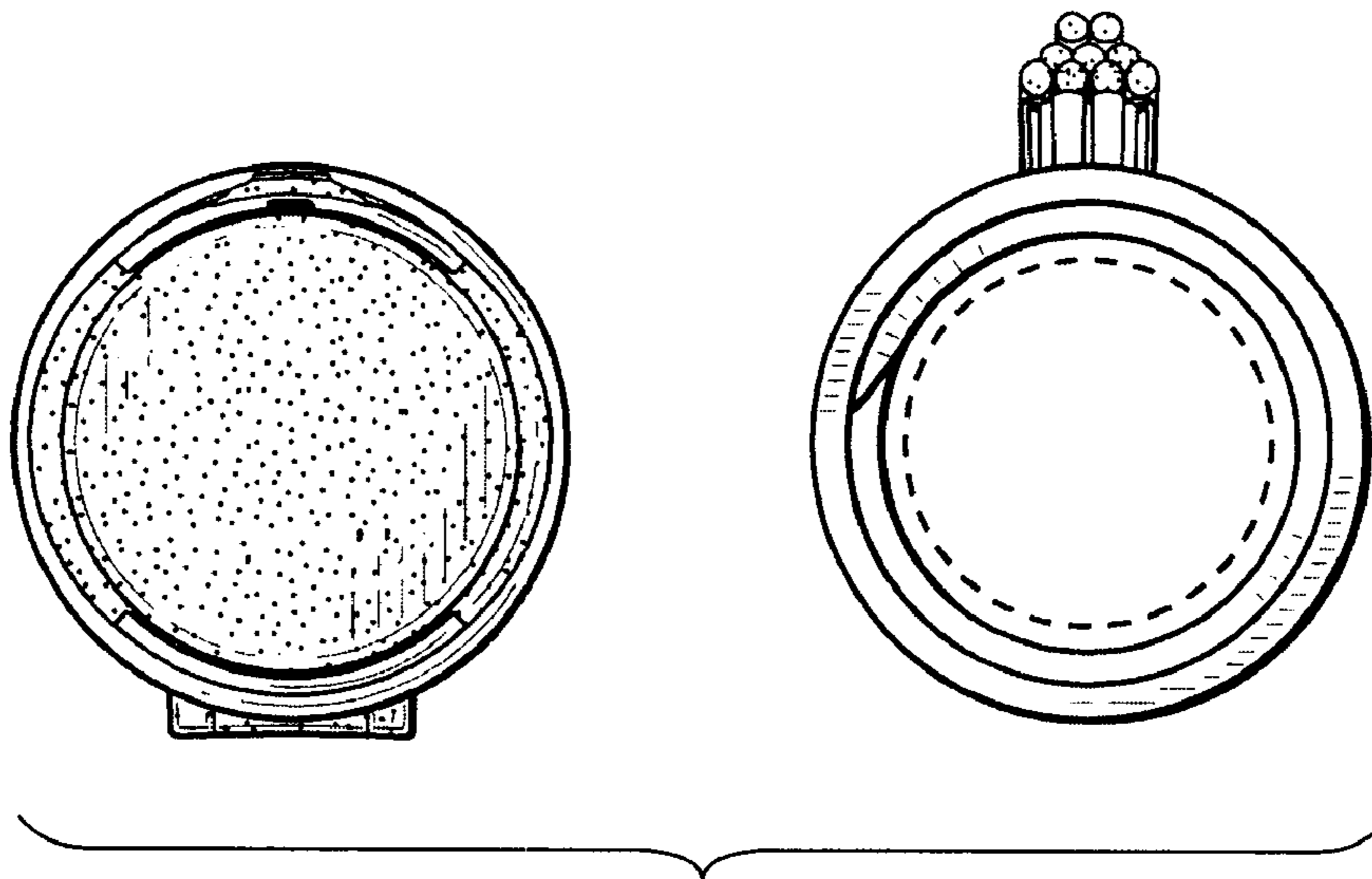

FIG. 13

UNITED STATES PATENT AND TRADEMARK OFFICE  
**CERTIFICATE OF CORRECTION**

PATENT NO. : Des. 476,485 S  
DATED : July 1, 2003  
INVENTOR(S) : Boyd William Franciscus Mulder et al.

Page 1 of 1

It is certified that error appears in the above-identified patent and that said Letters Patent is hereby corrected as shown below:

Title page,

Insert -- [73] Assignee: **Koninklijke Philips Electronics N.V.**,  
Eindhoven (NL) --.

Signed and Sealed this

Sixteenth Day of September, 2003

A handwritten signature in black ink, appearing to read "James E. Rogan", written over a horizontal line.

JAMES E. ROGAN  
*Director of the United States Patent and Trademark Office*