



US00D476478S

(12) **United States Design Patent**
Kanzawa

(10) **Patent No.:** **US D476,478 S**

(45) **Date of Patent:** **** Jul. 1, 2003**

(54) **SHEATH FOR PRUNING SAW**

(75) Inventor: **Kuniyuki Kanzawa, Miki (JP)**

(73) Assignee: **Kanzawa Seiko Co., Ltd., Hyogo (JP)**

(**) Term: **14 Years**

(21) Appl. No.: **29/148,778**

(22) Filed: **Sep. 27, 2001**

(30) **Foreign Application Priority Data**

Apr. 9, 2001 (JP) 2001-010267

(51) **LOC (7) Cl.** **03-01**

(52) **U.S. Cl.** **D3/220**

(58) **Field of Search** D3/220, 228, 262,
D3/269, 905; D8/93, 95; 30/151, 504; 206/349,
806, 372, 373

(56) **References Cited**

U.S. PATENT DOCUMENTS

- D411,948 S * 7/1999 Chipperfield D8/95
- D414,330 S * 9/1999 Eriksson et al. D3/220
- D435,400 S * 12/2000 Veltz et al. D3/220 X
- D443,759 S * 6/2001 Bloch D3/220

* cited by examiner

Primary Examiner—Catherine R. Oliver

(74) *Attorney, Agent, or Firm*—Koda & Androlia

(57) **CLAIM**

The ornamental design for a sheath for pruning saw, as shown and described.

DESCRIPTION

FIG. 1 is a top plan view of the sheath for pruning saw showing my new design;
 FIG. 2 is a front elevational view thereof;
 FIG. 3 is a bottom plan view thereof;
 FIG. 4 is a rear elevational view thereof;
 FIG. 5 is a left side elevational thereof; and
 FIG. 6 is a right side elevational view thereof.
 FIG. 7 is an enlarged cross-sectional view taken along the line 7—7 in FIG. 2;
 FIG. 8 is an enlarged cross-sectional view taken along the line 8—8 in FIG. 2;
 FIG. 9 is an enlarged cross-sectional view taken along the line 9—9 in FIG. 2; and,
 FIG. 10 is an enlarged cross-sectional view taken along the line 10—10 in FIG. 1.

1 Claim, 2 Drawing Sheets

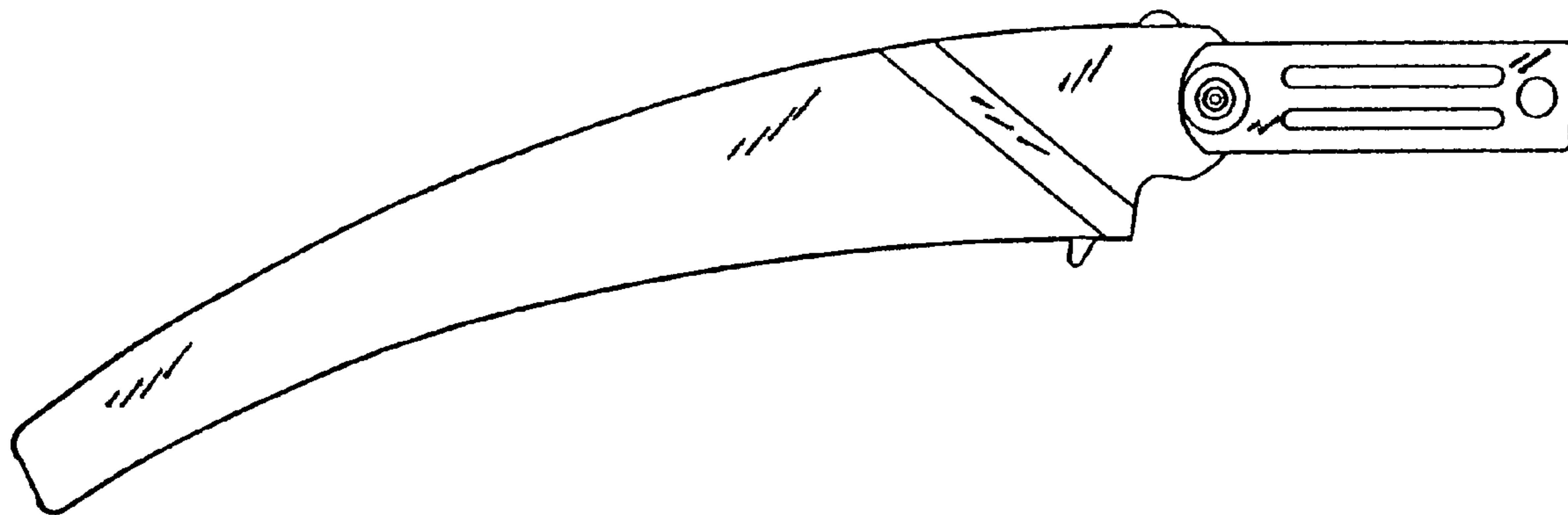

FIG. 1

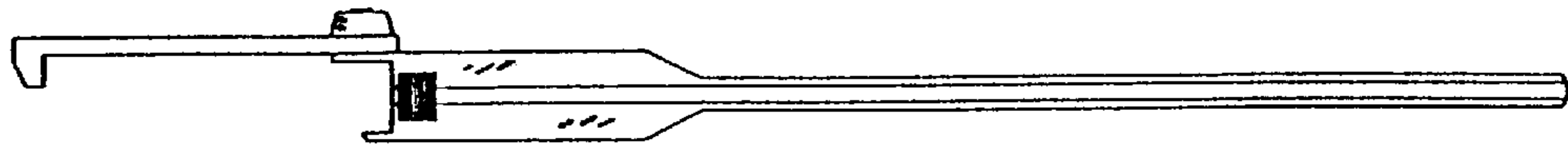

FIG. 2

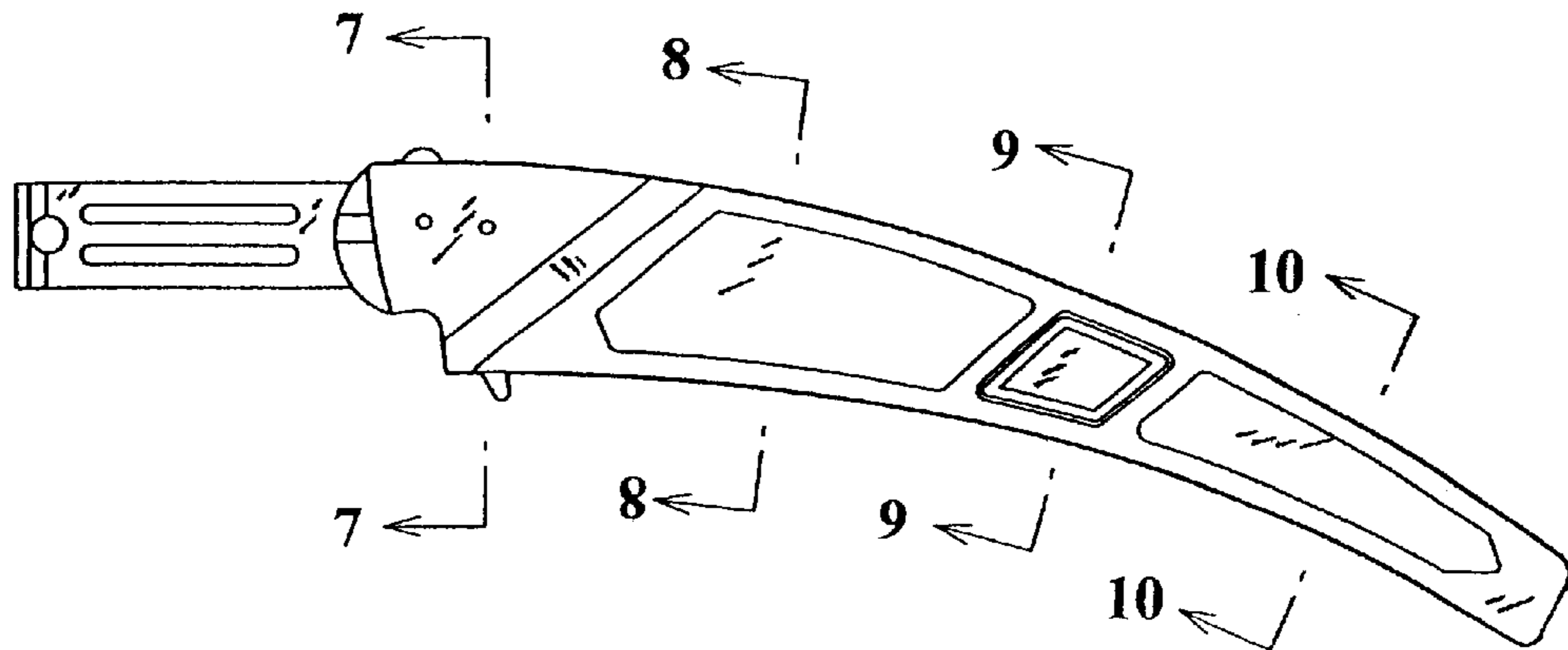

FIG. 3

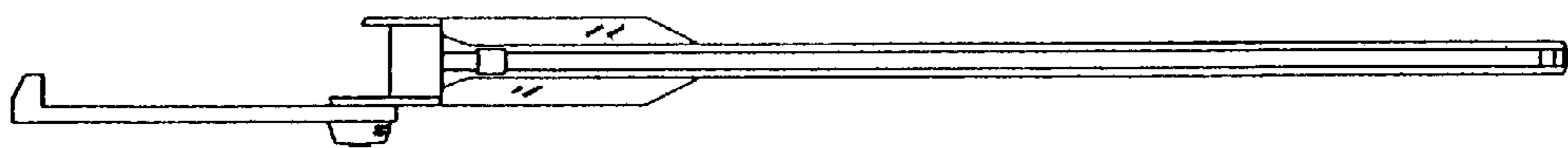

FIG. 4

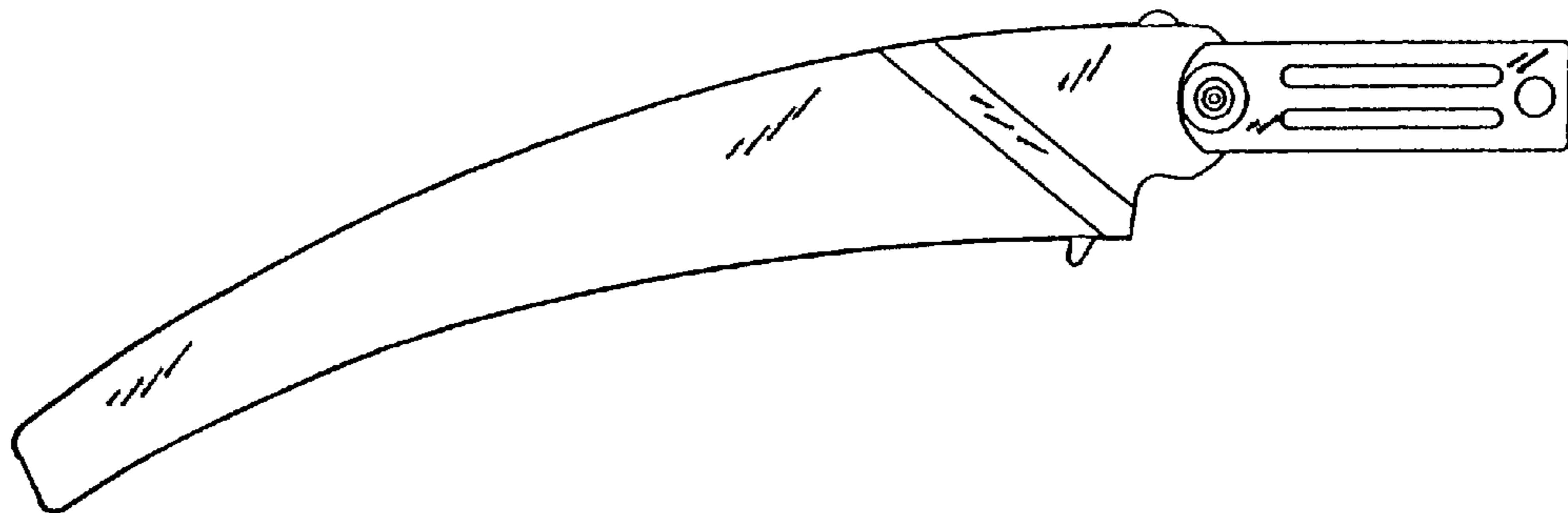

FIG. 5

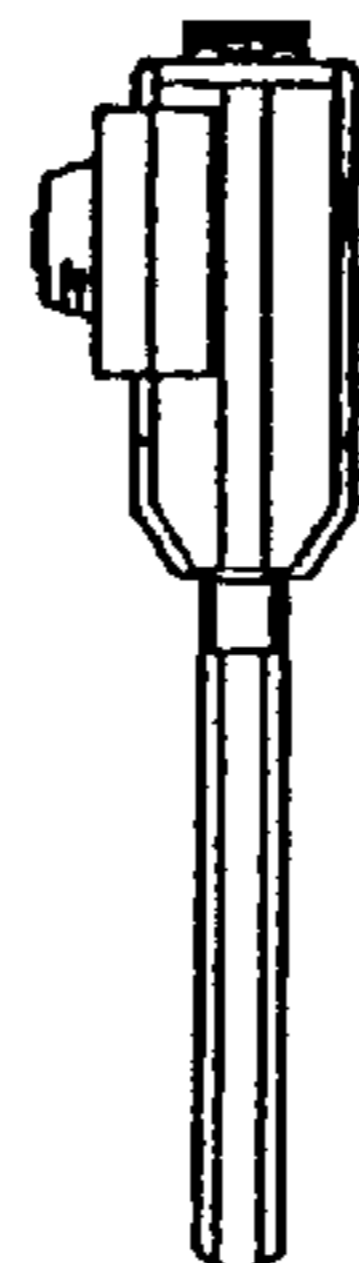

FIG. 6

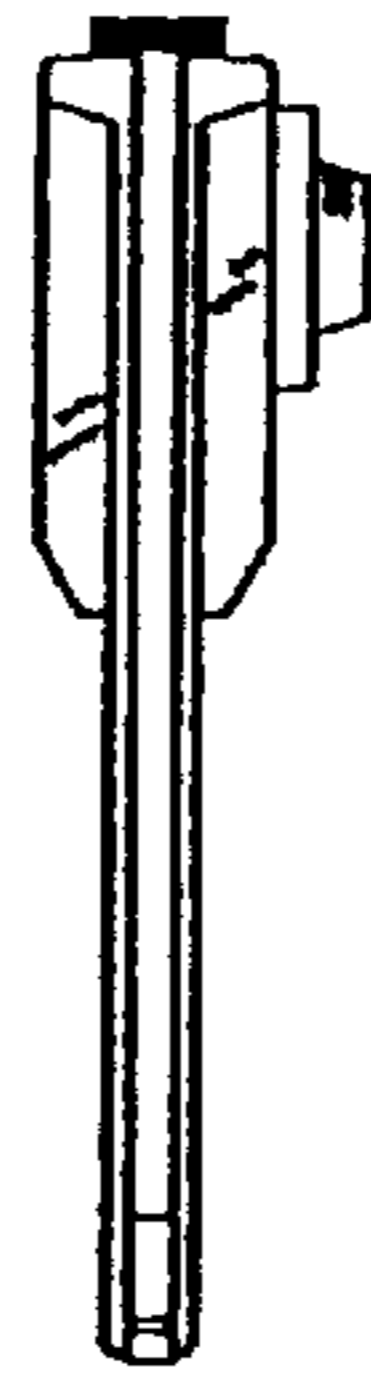

FIG. 7

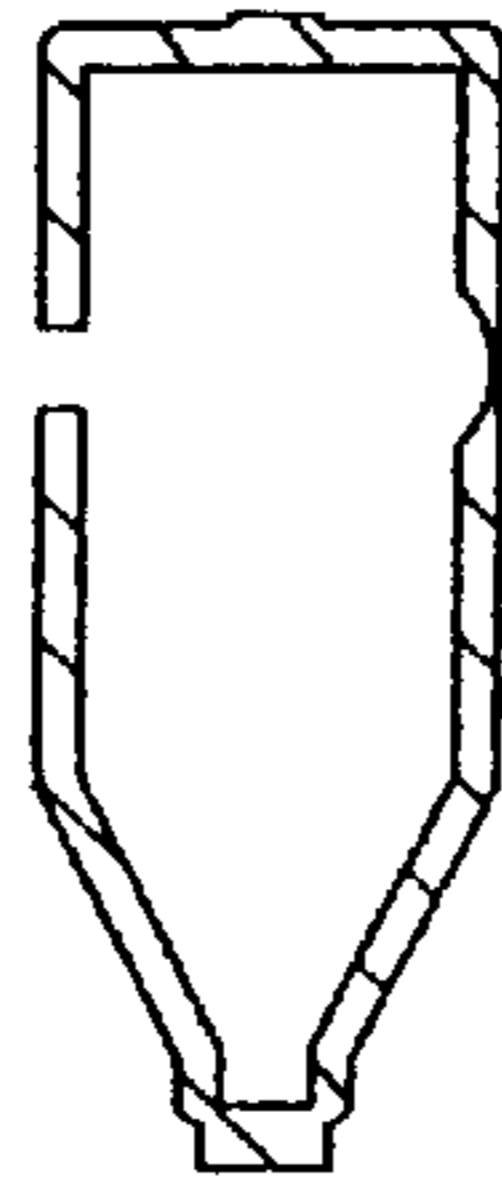

FIG. 8



FIG. 9



FIG. 10

