



US00D476322S

(12) **United States Design Patent**
Arbisi et al.

(10) **Patent No.:** **US D476,322 S**
(45) **Date of Patent:** **** Jun. 24, 2003**

(54) **FRONT COVER FOR A HANDSET**

(75) Inventors: **Thomas Arbisi**, Newbury Park, CA
(US); **Todd Wood**, Los Angeles, CA
(US)

(73) Assignee: **Nokia Corporation**, Espoo (FI)

(**) Term: **14 Years**

(21) Appl. No.: **29/162,431**

(22) Filed: **Jun. 14, 2002**

(51) **LOC (7) Cl.** **14-03**

(52) **U.S. Cl.** **D14/248**

(58) **Field of Search** D14/137, 138,
D14/218, 147-148, 247-248, 144, 341-347;
379/433.01-433.13, 419, 434, 428.01-428.04,
420.01-420.04, 440; 455/550-575, 90;
D21/517

(56) **References Cited**

U.S. PATENT DOCUMENTS

D407,399 S	*	3/1999	Frye et al.	D14/138
D407,719 S	*	4/1999	Nagano et al.	D14/138
D407,720 S	*	4/1999	Nagano et al.	D14/138
D408,397 S	*	4/1999	Renard	D14/138
D410,002 S	*	5/1999	Collins	D14/138
5,901,367 A	*	5/1999	Toh	455/575
D411,205 S	*	6/1999	Frye et al.	D14/250
D422,597 S	*	4/2000	Finkbeiner	D14/248
D425,057 S	*	5/2000	Finkbeiner	D14/138
D425,074 S	*	5/2000	Frye et al.	D14/248
D426,531 S	*	6/2000	Chikaraishi et al.	D14/138
D427,171 S	*	6/2000	Frye et al.	D14/138
D429,491 S	*	8/2000	Finkbeiner	D14/248
D430,127 S	*	8/2000	Collins et al.	D14/138
D434,016 S	*	11/2000	Hunt	D14/138
D434,744 S	*	12/2000	Lai	D14/138
D436,102 S	*	1/2001	Wu	D14/248

D439,573 S	*	3/2001	DeLeon	D14/138
D443,600 S	*	6/2001	Ogawa	D14/138
D443,607 S	*	6/2001	Kolinen	D14/248
D446,509 S	*	8/2001	Chiu	D14/138
D448,022 S	*	9/2001	Higashi et al.	D14/248
D448,355 S	*	9/2001	Higashi et al.	D14/138
D449,597 S	*	10/2001	Tan et al.	D14/248
D451,093 S	*	11/2001	Tan et al.	D14/248
D451,914 S	*	12/2001	Vuolteenaho et al.	D14/248
D452,235 S	*	12/2001	Langford et al.	D14/248
D455,134 S	*	4/2002	Kolinen	D14/138
D455,726 S	*	4/2002	Kolinen	D14/138
D459,332 S	*	6/2002	Peiker	D14/147
D461,174 S	*	8/2002	Ruohonen	D14/138
D461,467 S	*	8/2002	Ruohonen	D14/248
D464,940 S	*	10/2002	Jung	D14/138
6,463,263 B1	*	10/2002	Feilner et al.	455/90

* cited by examiner

Primary Examiner—Jeffrey Asch

(74) *Attorney, Agent, or Firm*—Banner & Witcoff, Ltd.

(57) **CLAIM**

We claim the ornamental design for a front cover for a handset, as shown.

DESCRIPTION

FIG. 1 is a bottom plan view of the front cover for a handset; FIG. 2 is a right side view thereof; FIG. 3 is front view thereof; FIG. 4 is a left side view thereof; FIG. 5 is a top plan view thereof; FIG. 6 is a perspective view thereof; and, FIG. 7 is a perspective front view thereof.

The broken line showing of the downwardly extending projections of the front cover is for illustrative purposes only and forms no part of the claimed design. The underside of the front cover forms no part of the claimed design.

1 Claim, 2 Drawing Sheets

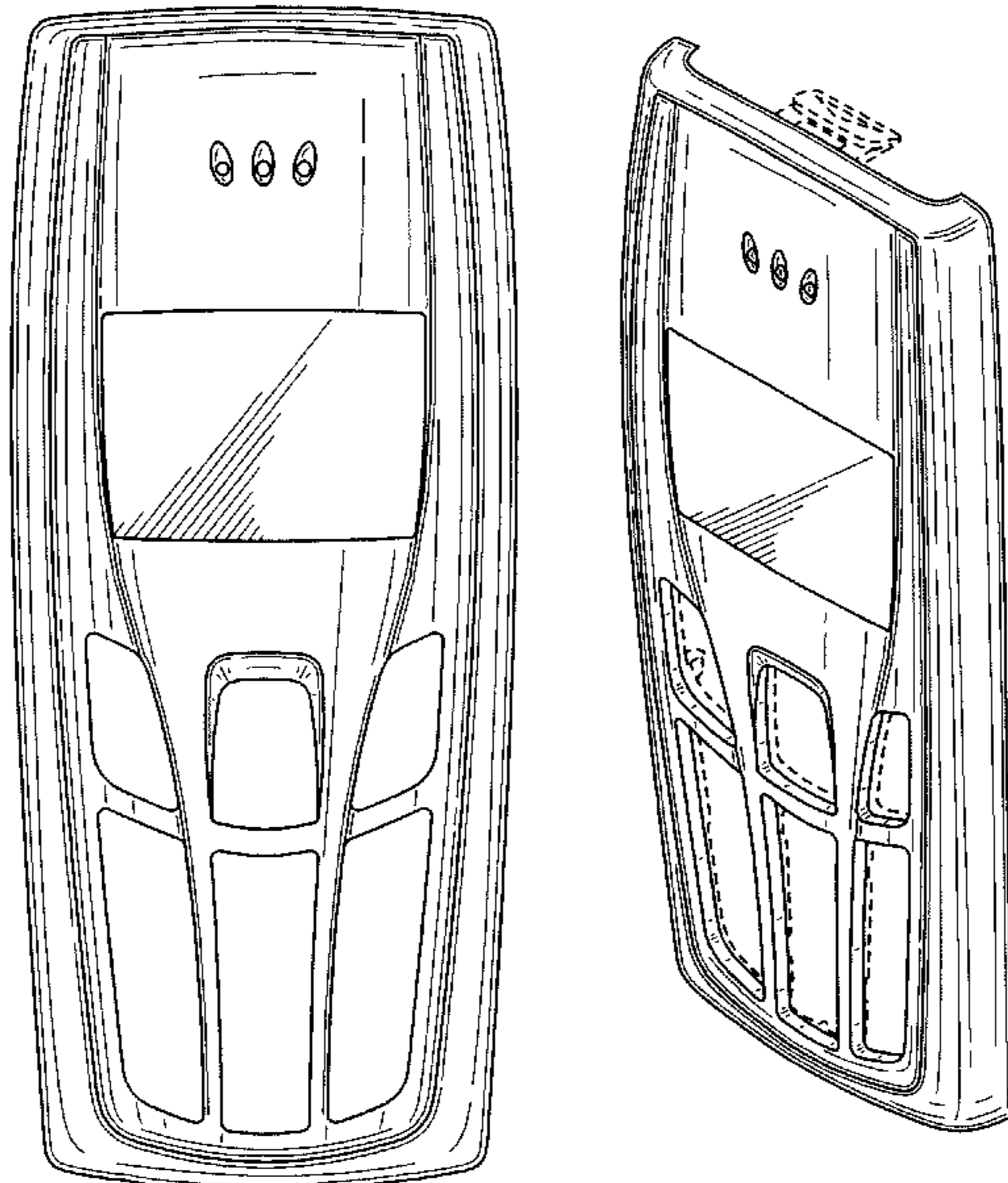

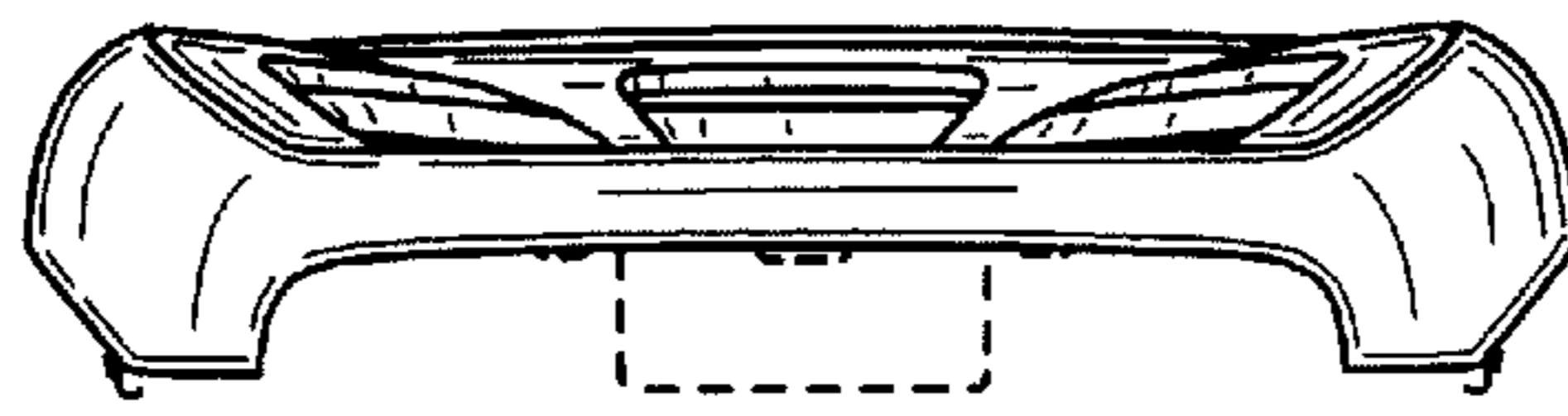

FIG. 1

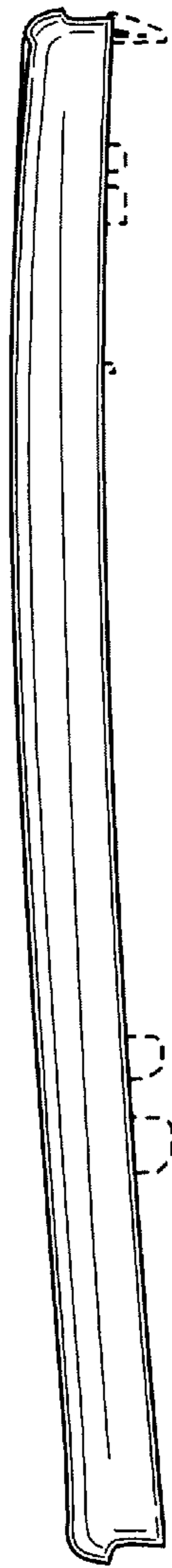

FIG. 2

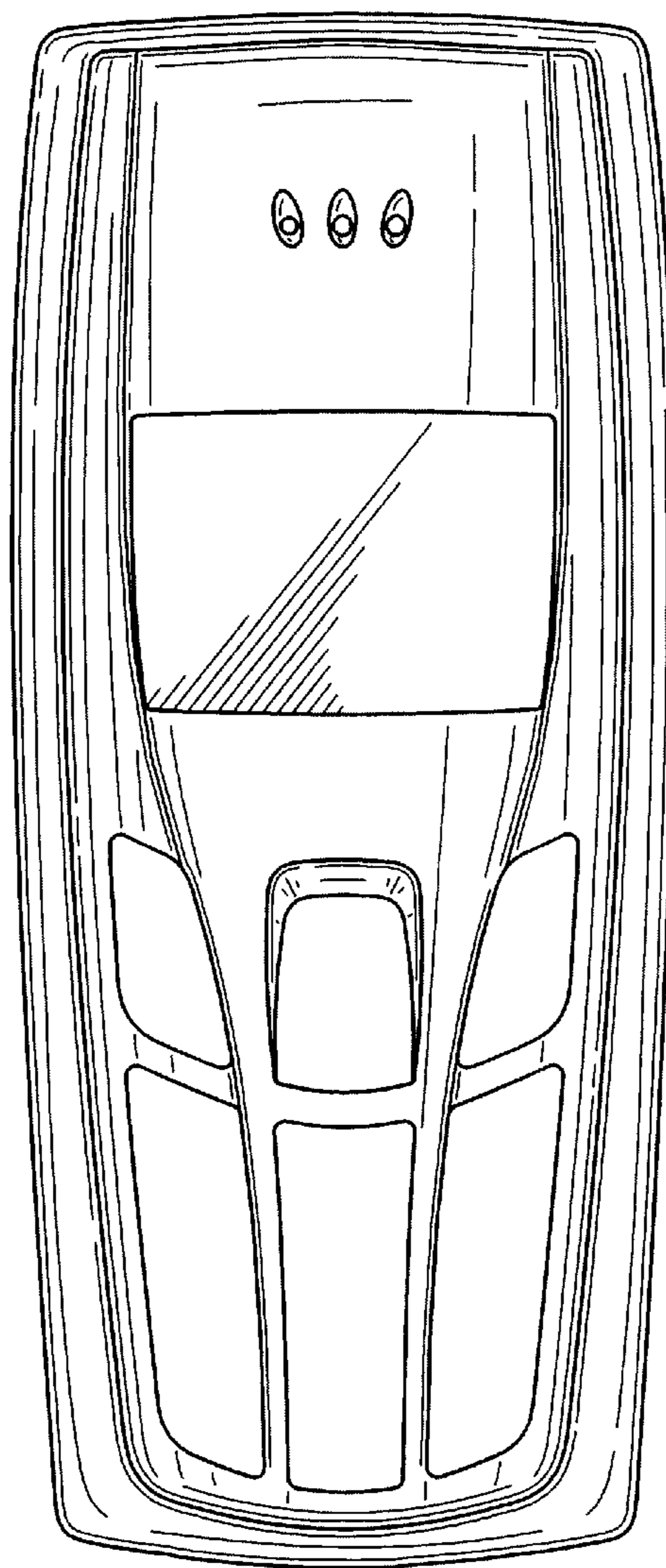

FIG. 3

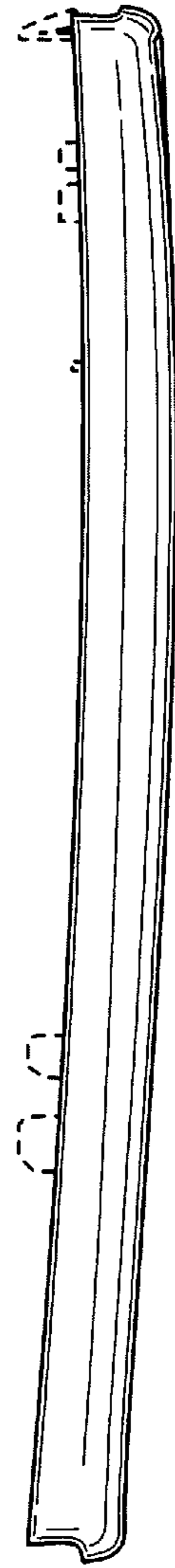
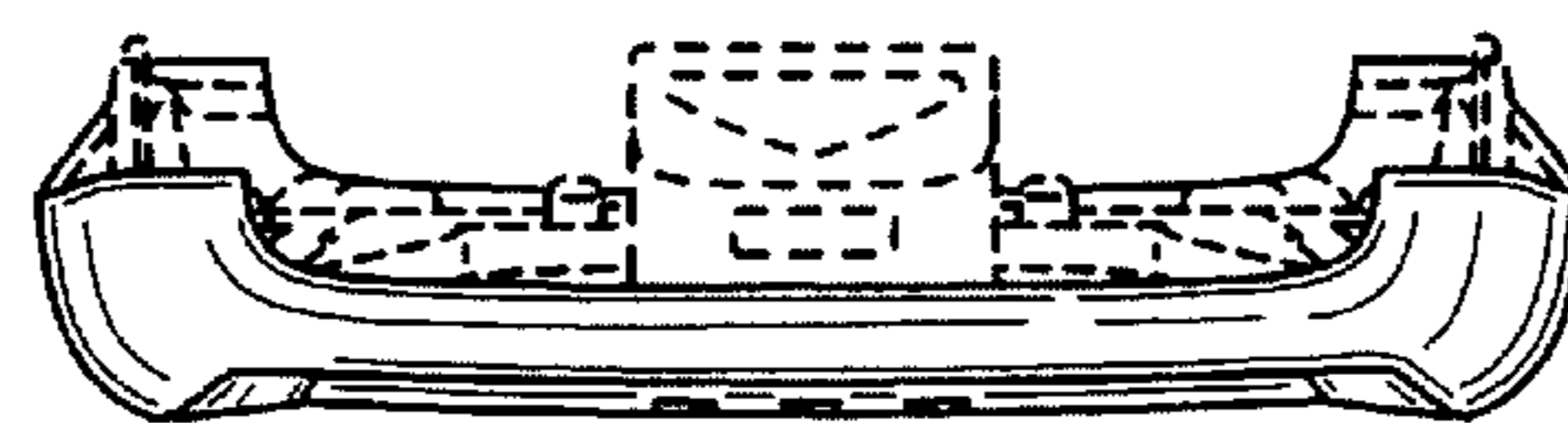

FIG. 4

FIG. 5



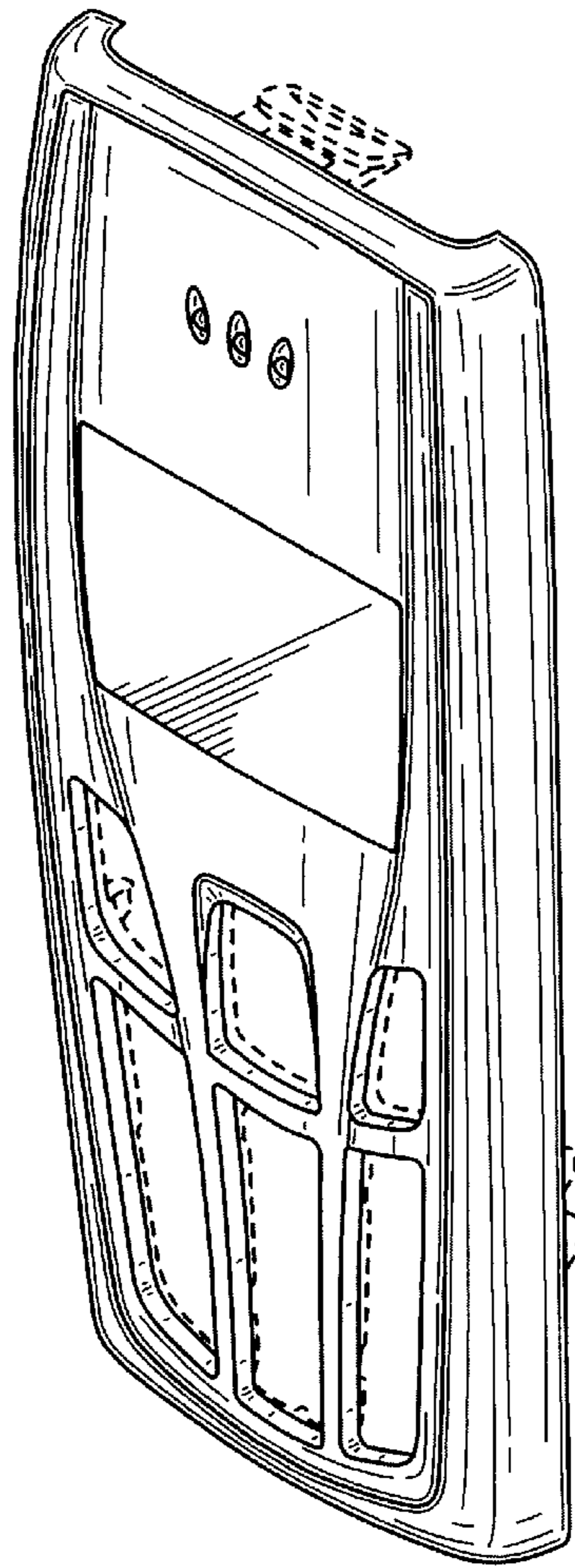

FIG. 6

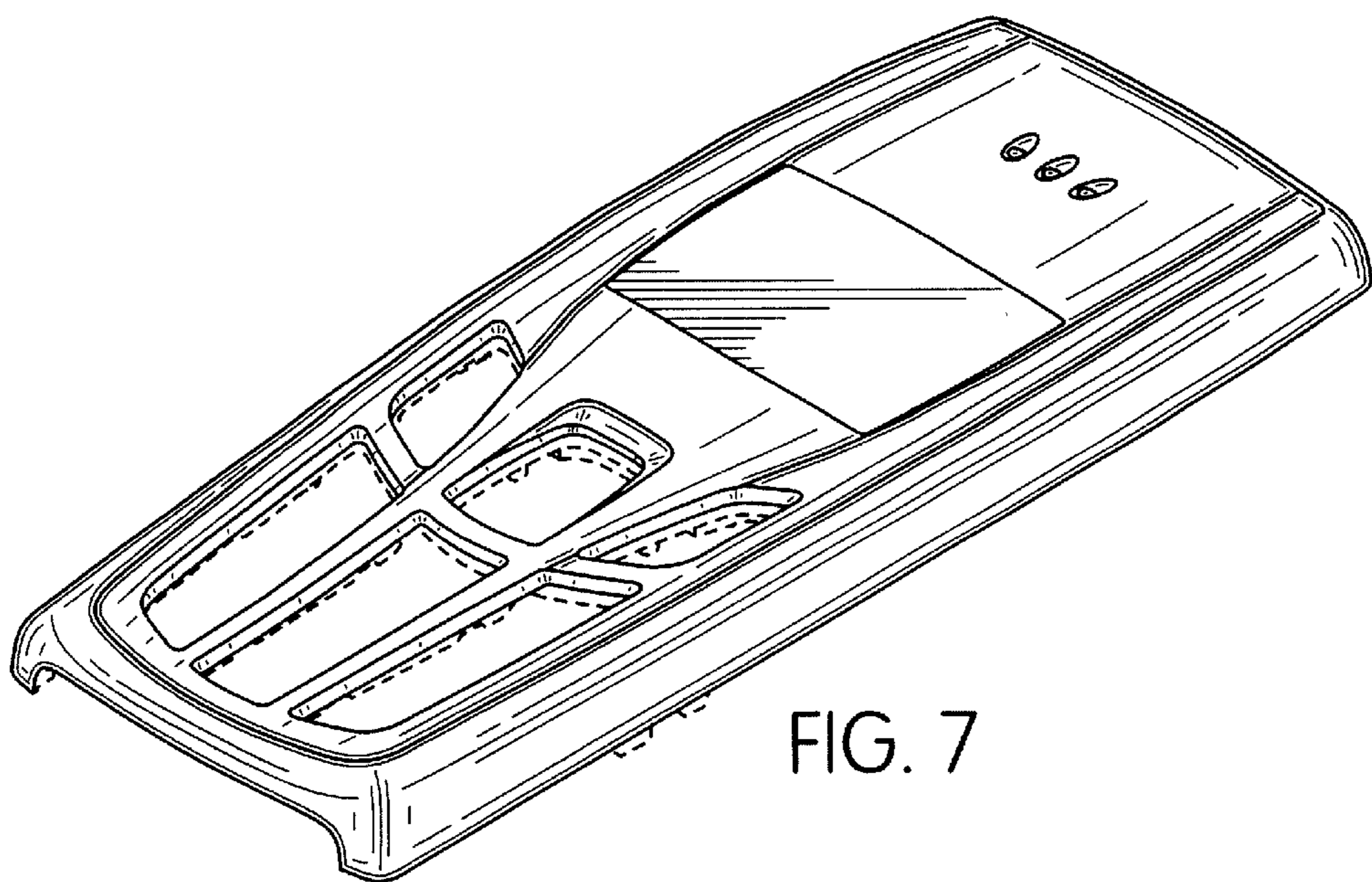

FIG. 7