



US00D476275S

(12) **United States Design Patent**  
**Winkler et al.**

(10) **Patent No.:** **US D476,275 S**

(45) **Date of Patent:** **\*\* Jun. 24, 2003**

(54) **BRAKE CALIPER COVER FOR AN  
AUTOMOBILE**

(75) Inventors: **Vance Winkler**, Trotwood, OH (US);  
**Merle T. Brumfield**, Tipp City, OH  
(US); **Carol Gardner**, Lewisburg, OH  
(US)

(73) Assignee: **Harco Industries, Inc.**, Englewood,  
OH (US)

(\*\*) Term: **14 Years**

(21) Appl. No.: **29/167,338**

(22) Filed: **Sep. 13, 2002**

(51) **LOC (7) Cl.** ..... **12-16**

(52) **U.S. Cl.** ..... **D12/180**

(58) **Field of Search** ..... D12/180; 188/73.31-73.34,  
188/73.43-73.45, 218

(56) **References Cited**

**U.S. PATENT DOCUMENTS**

D291,189 S 8/1987 Stahel  
5,538,105 A \* 7/1996 Rike ..... 188/73.32  
D378,363 S \* 3/1997 Sin ..... D12/180

D397,968 S 9/1998 Stahel  
D417,178 S \* 11/1999 Gallagher ..... D12/180  
D458,199 S \* 6/2002 Demoise, Jr. et al. .... D12/180  
D468,242 S \* 1/2003 Iida ..... D12/180  
D468,243 S \* 1/2003 Iida ..... D12/180

\* cited by examiner

*Primary Examiner*—Melody N. Brown

(74) *Attorney, Agent, or Firm*—Jacox, Meckstroth &  
Jenkins

(57) **CLAIM**

The ornamental design of a brake caliper cover for an  
automobile, as shown and described.

**DESCRIPTION**

FIG. 1 is a perspective view of a brake caliper cover for an  
automobile, showing our new design;  
FIG. 2 is a top view thereof;  
FIG. 3 is a front view thereof;  
FIG. 4 is a rear view thereof;  
FIG. 5 is a bottom view thereof;  
FIG. 6 is a view of one end thereof; and,  
FIG. 7 is a view of the opposite end thereof.

**1 Claim, 2 Drawing Sheets**

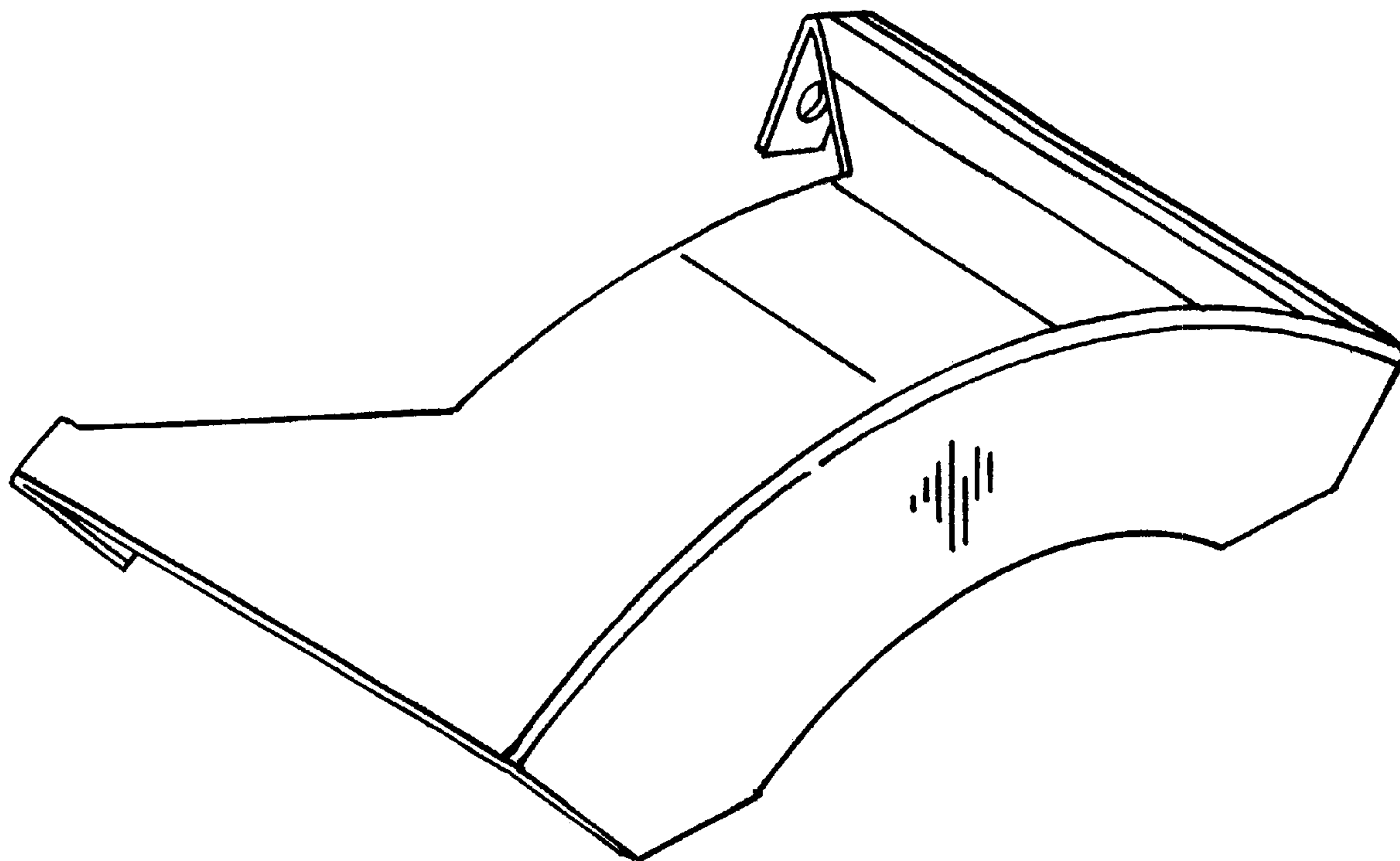

FIG-1

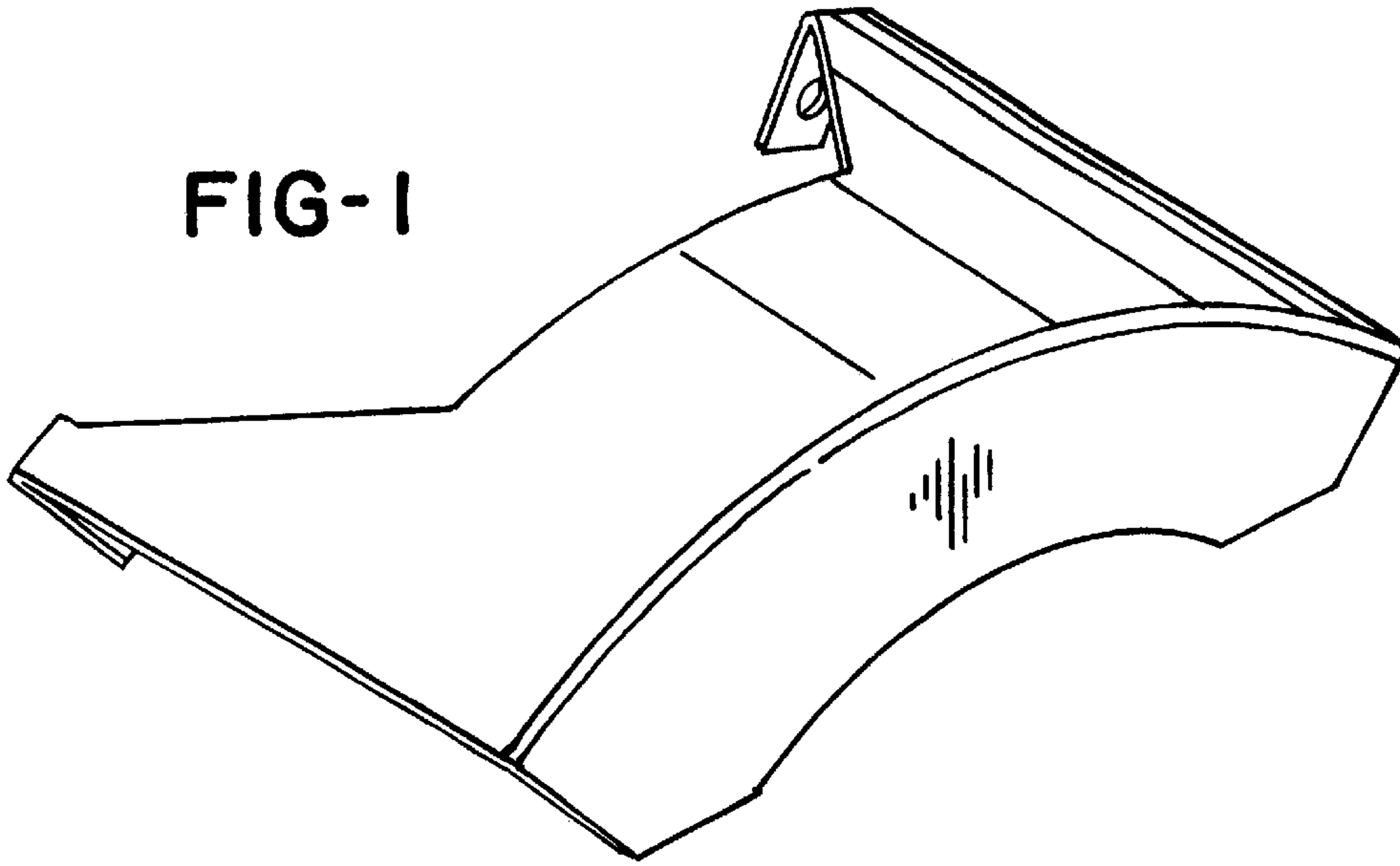

FIG-2

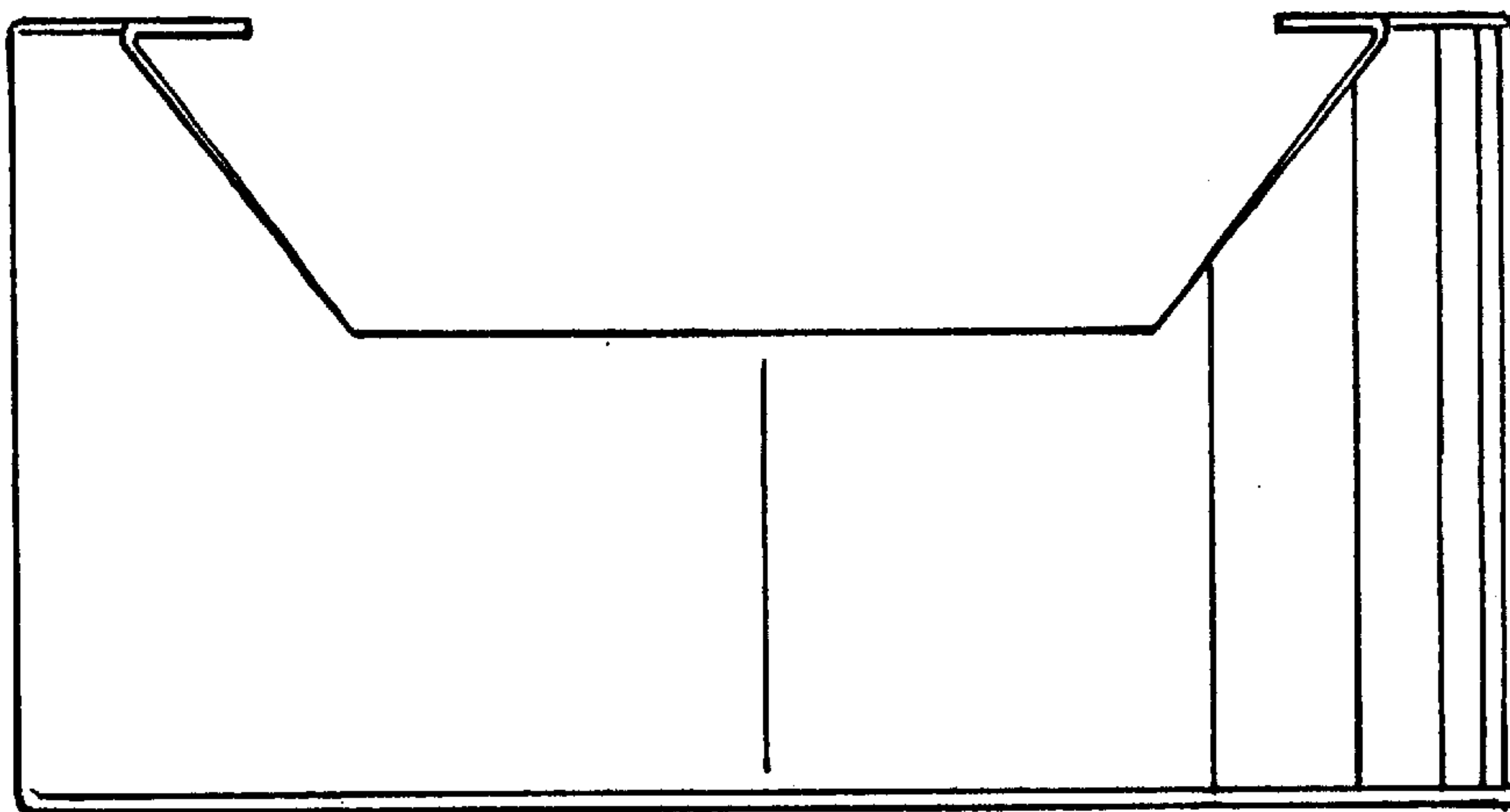
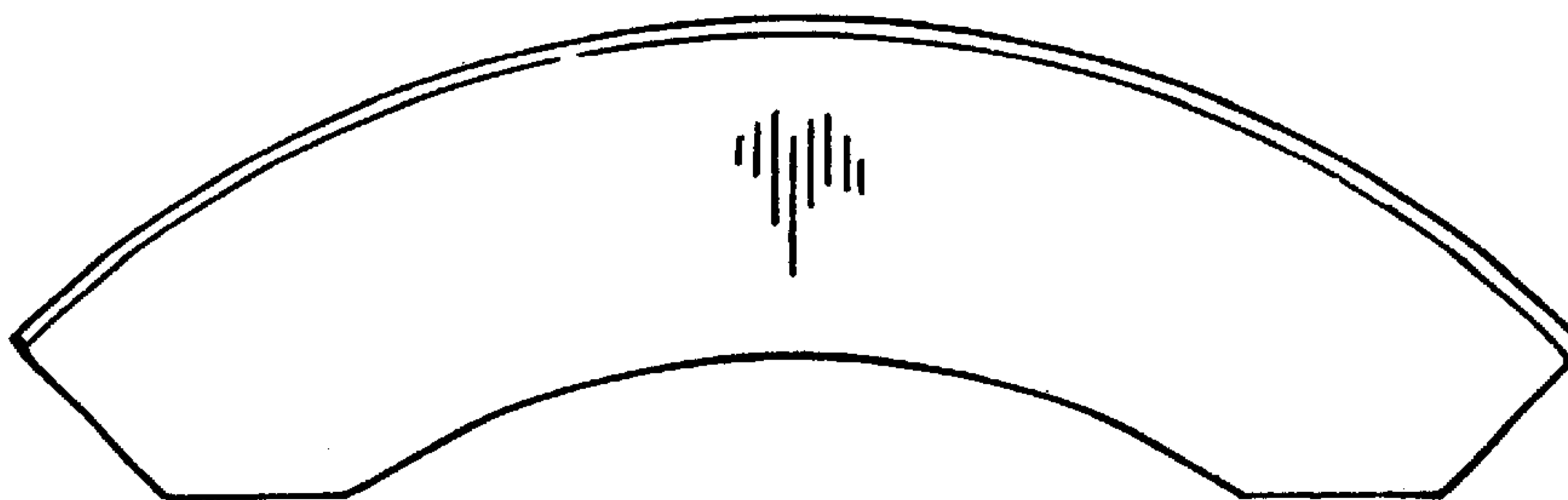
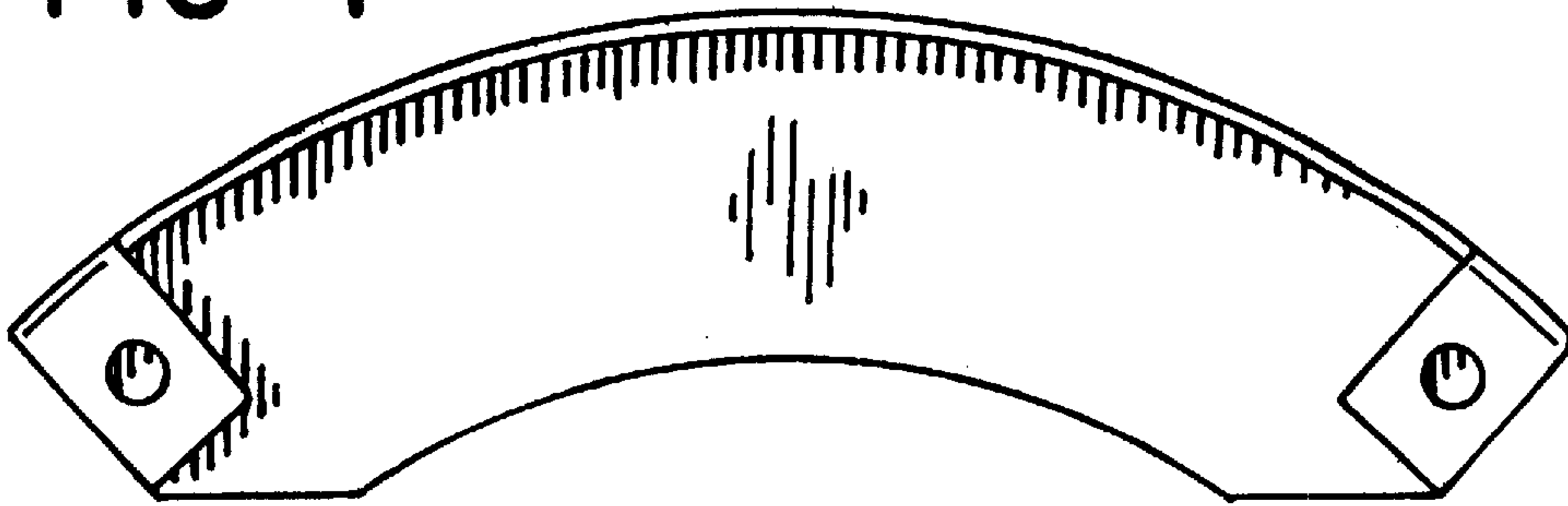

FIG-3



**FIG-4**



**FIG-5**

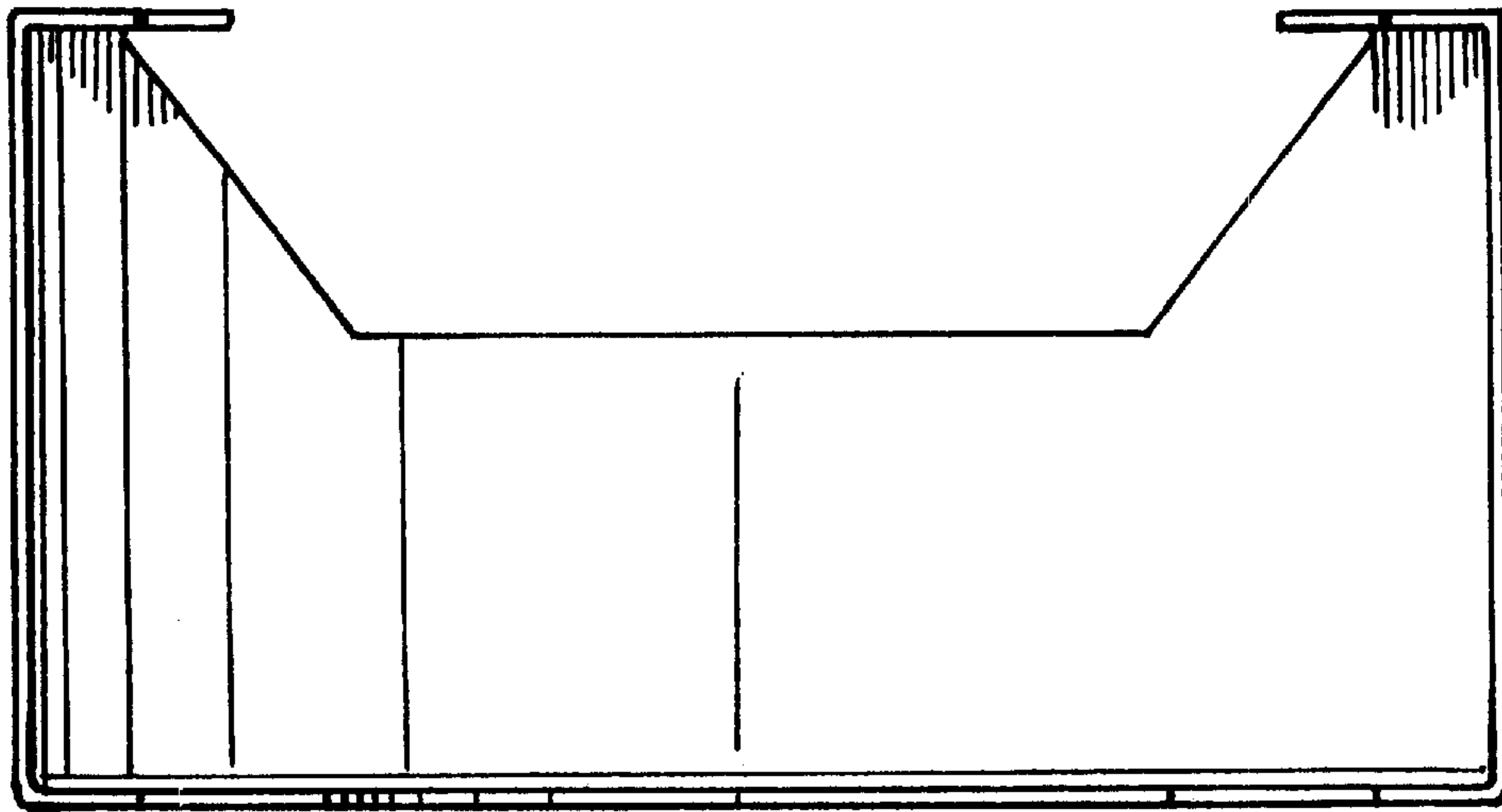

**FIG-6**

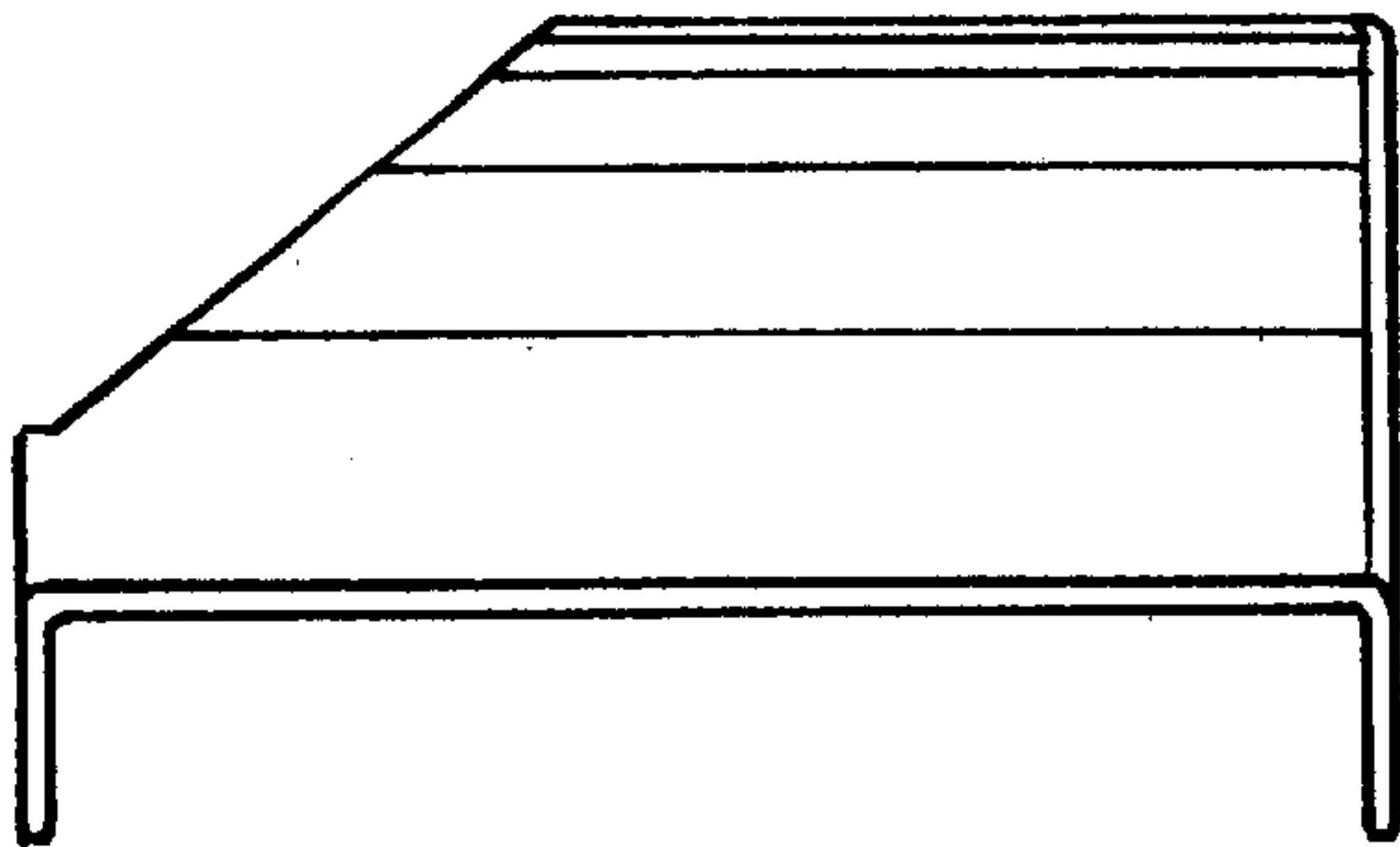

**FIG-7**

