



US00D476270S

(12) **United States Design Patent**  
**Bailey**

(10) **Patent No.:** **US D476,270 S**

(45) **Date of Patent:** **\*\* Jun. 24, 2003**

(54) **MODEL VEHICLE**

(75) **Inventor:** **Stephen J. Bailey**, Lutterworth (GB)

(73) **Assignee:** **Gibbs International Technologies Limited**, Channel Islands (GB)

(\*\*) **Term:** **14 Years**

(21) **Appl. No.:** **29/148,105**

(22) **Filed:** **Sep. 14, 2001**

(30) **Foreign Application Priority Data**

Jun. 30, 2001 (GB) ..... 2102931

(51) **LOC (7) Cl.** ..... **12-08**

(52) **U.S. Cl.** ..... **D12/92**

(58) **Field of Search** ..... D12/90-92, 86;  
D21/421, 433; 296/185

(56) **References Cited**

**U.S. PATENT DOCUMENTS**

- D321,679 S \* 11/1991 Shinoda ..... D12/91
- D439,551 S \* 3/2001 Hatt et al. .... D12/92
- D449,254 S \* 10/2001 Larson ..... D12/92

\* cited by examiner

*Primary Examiner*—Melody N. Brown  
(74) *Attorney, Agent, or Firm*—Young & Basile, P.C.

(57) **CLAIM**

The ornamental design for a model vehicle, as shown and described.

**DESCRIPTION**

FIG. 1 is a front elevational view of a model vehicle showing my new design;  
 FIG. 2 is a rear elevational view thereof;  
 FIG. 3 is a plan elevational view thereof;  
 FIG. 4 is a bottom elevational view thereof;  
 FIG. 5 is a right side elevational view thereof;  
 FIG. 6 is a left side perspective view thereof;  
 FIG. 7 is a three-quarter front perspective view thereof;  
 FIG. 8 is a three-quarter rear perspective view thereof;  
 FIG. 9 is a rear interior perspective view thereof;  
 FIG. 10 is a side interior perspective view thereof;  
 FIG. 11 is a three-quarter rear, bottom perspective view thereof; and,  
 FIG. 12 is a right-side bottom perspective view thereof.

**1 Claim, 12 Drawing Sheets**

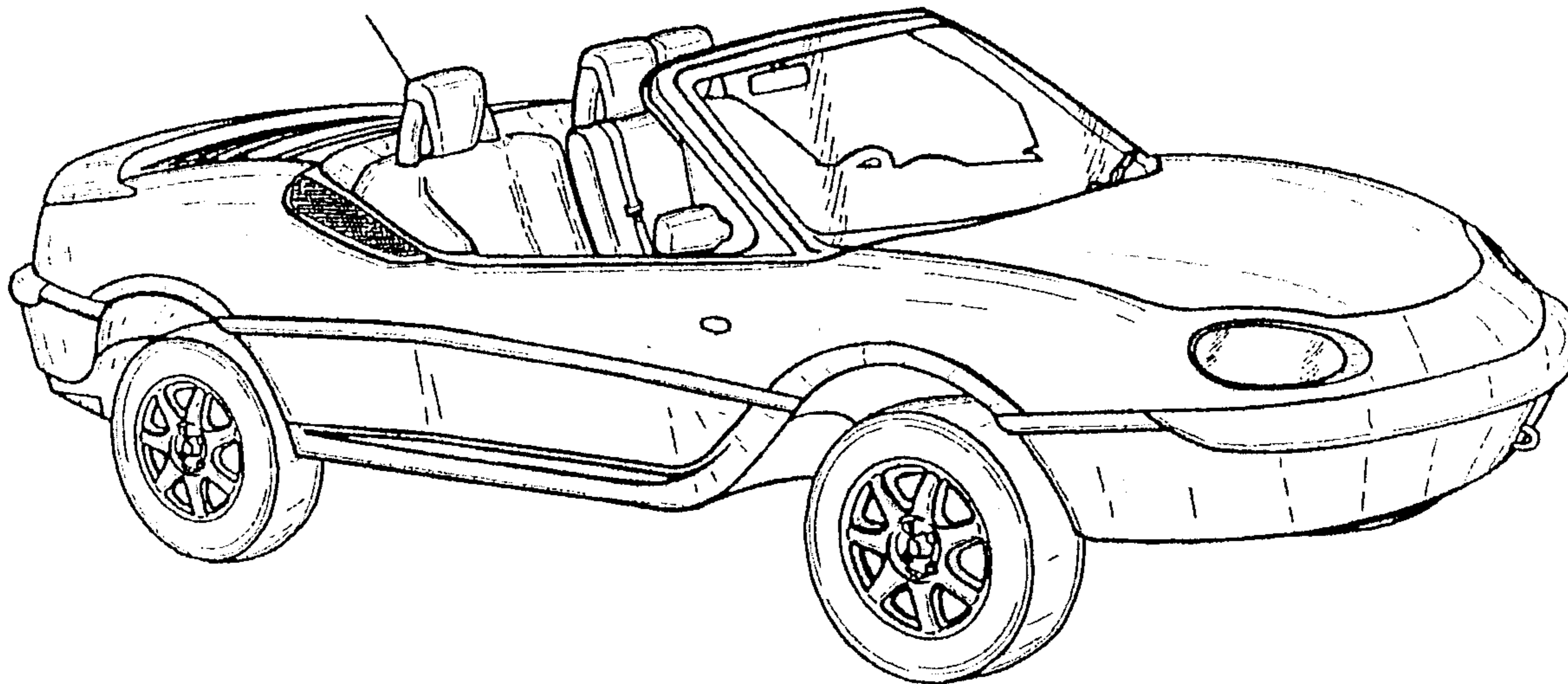

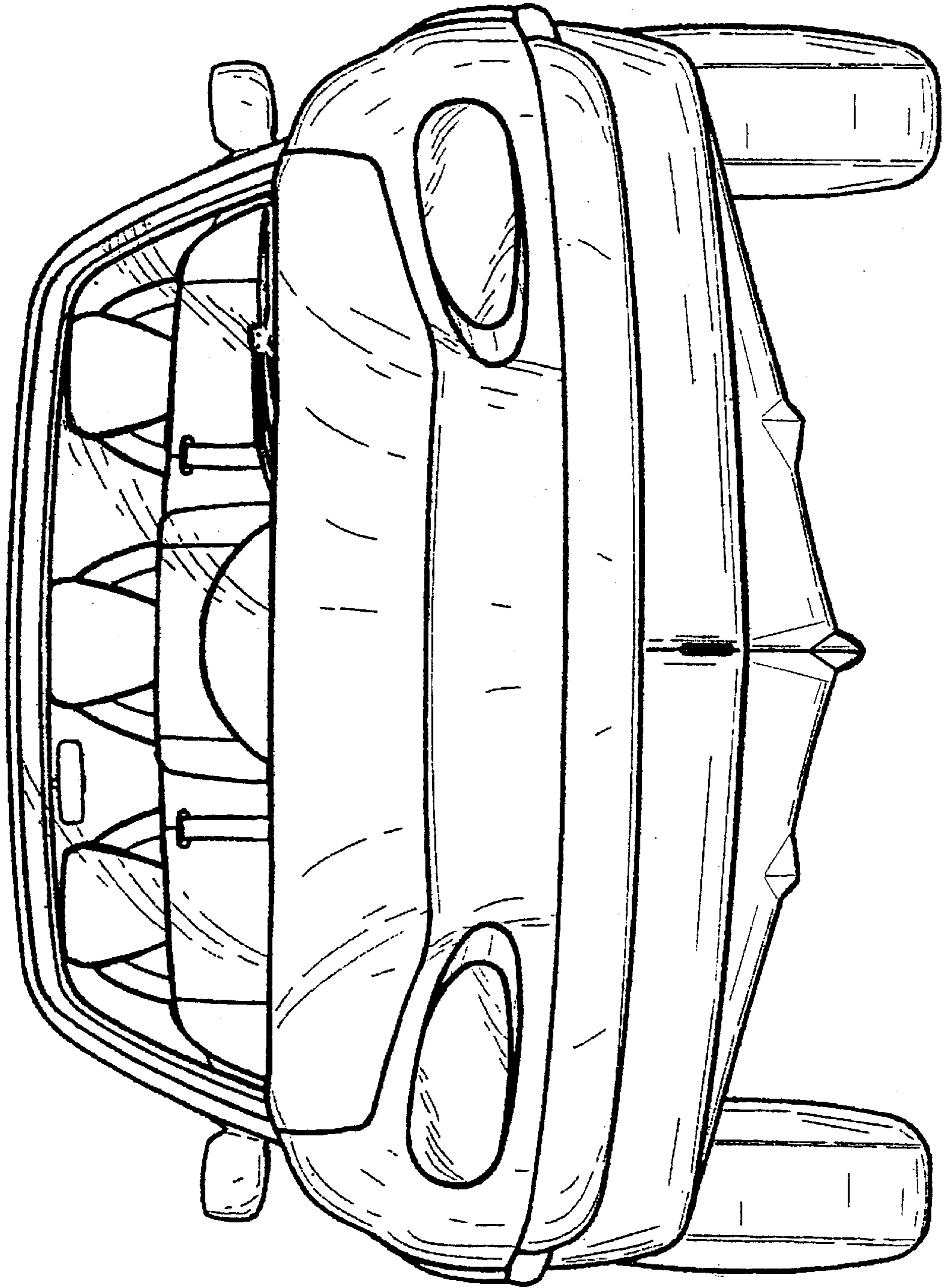

FIG - 1



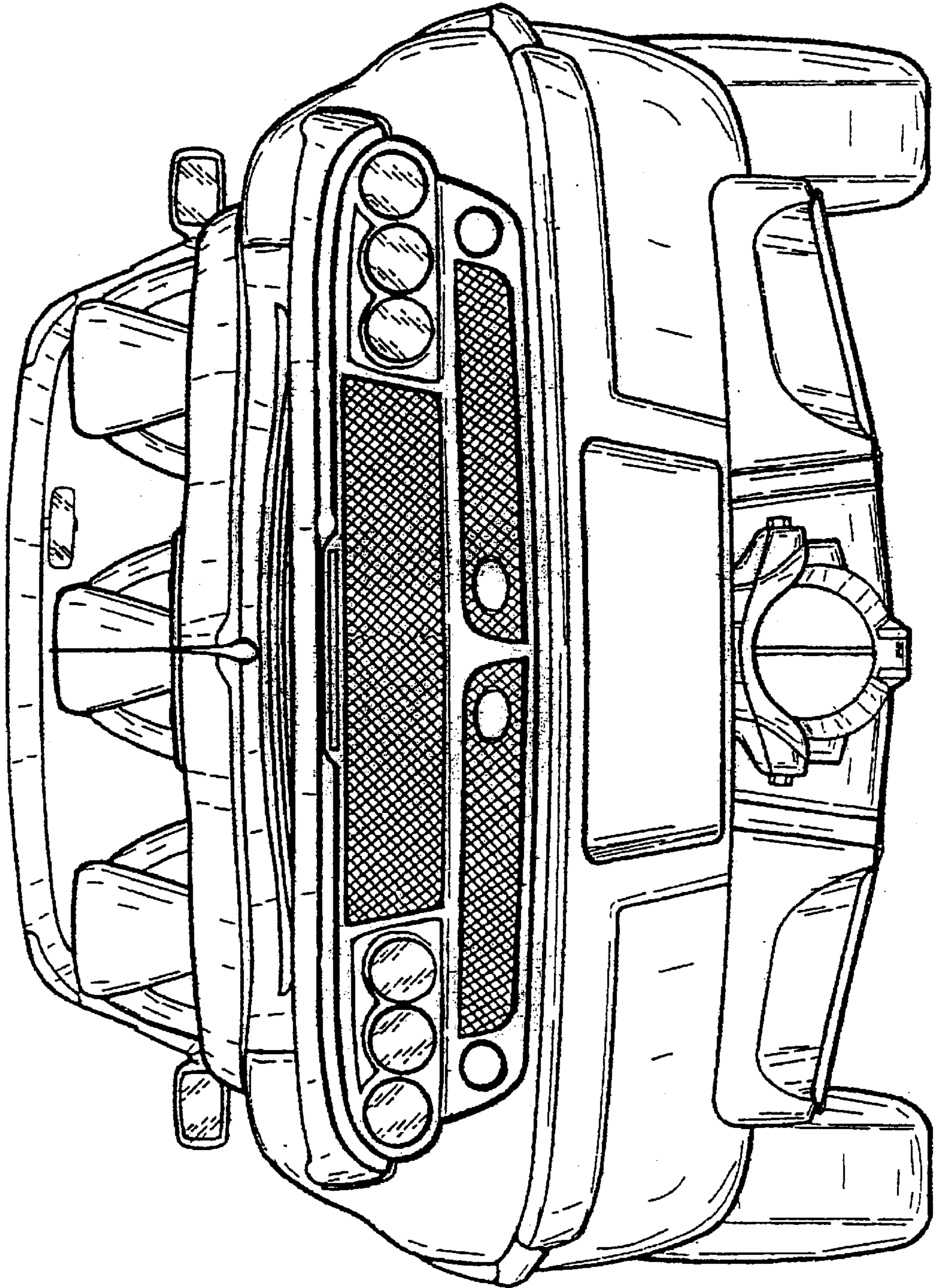

FIG - 2

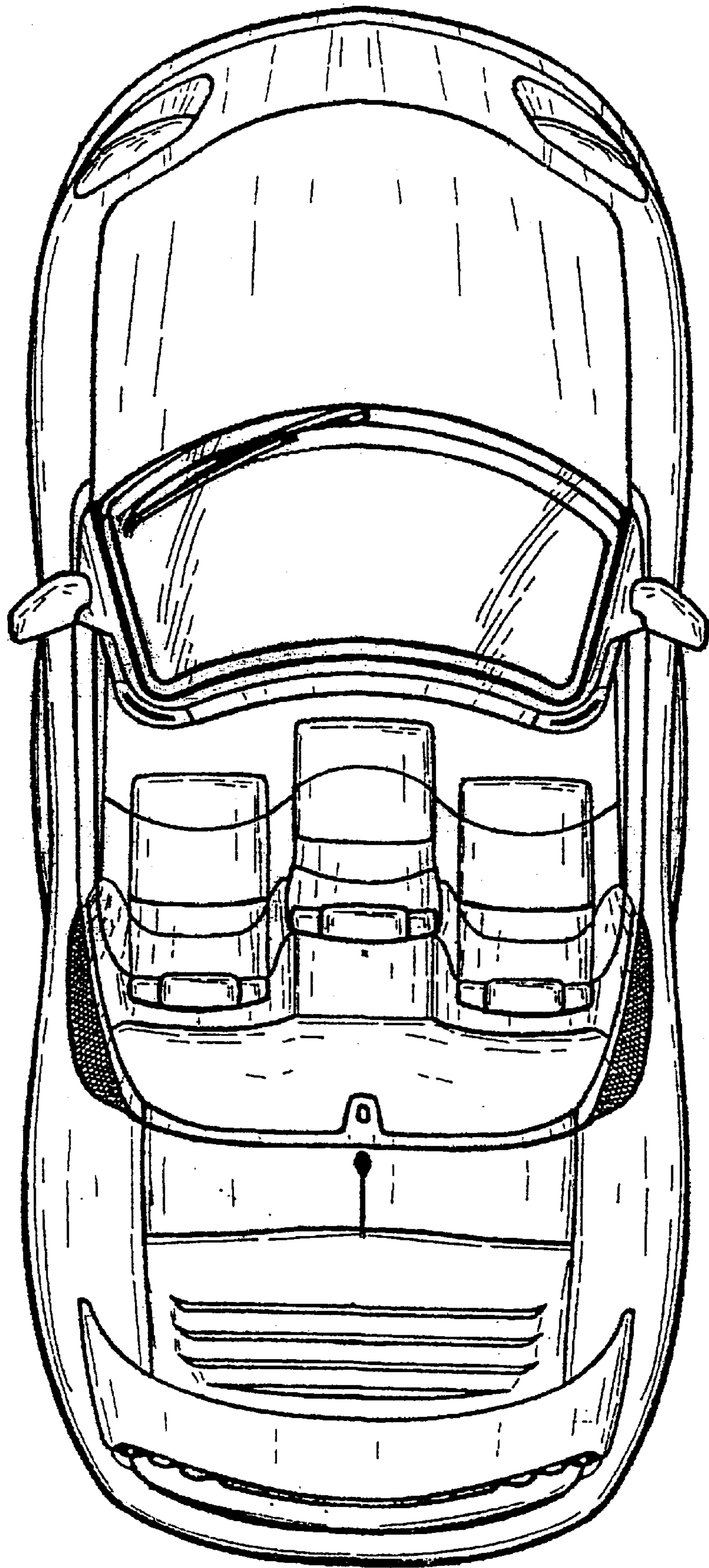

FIG - 3

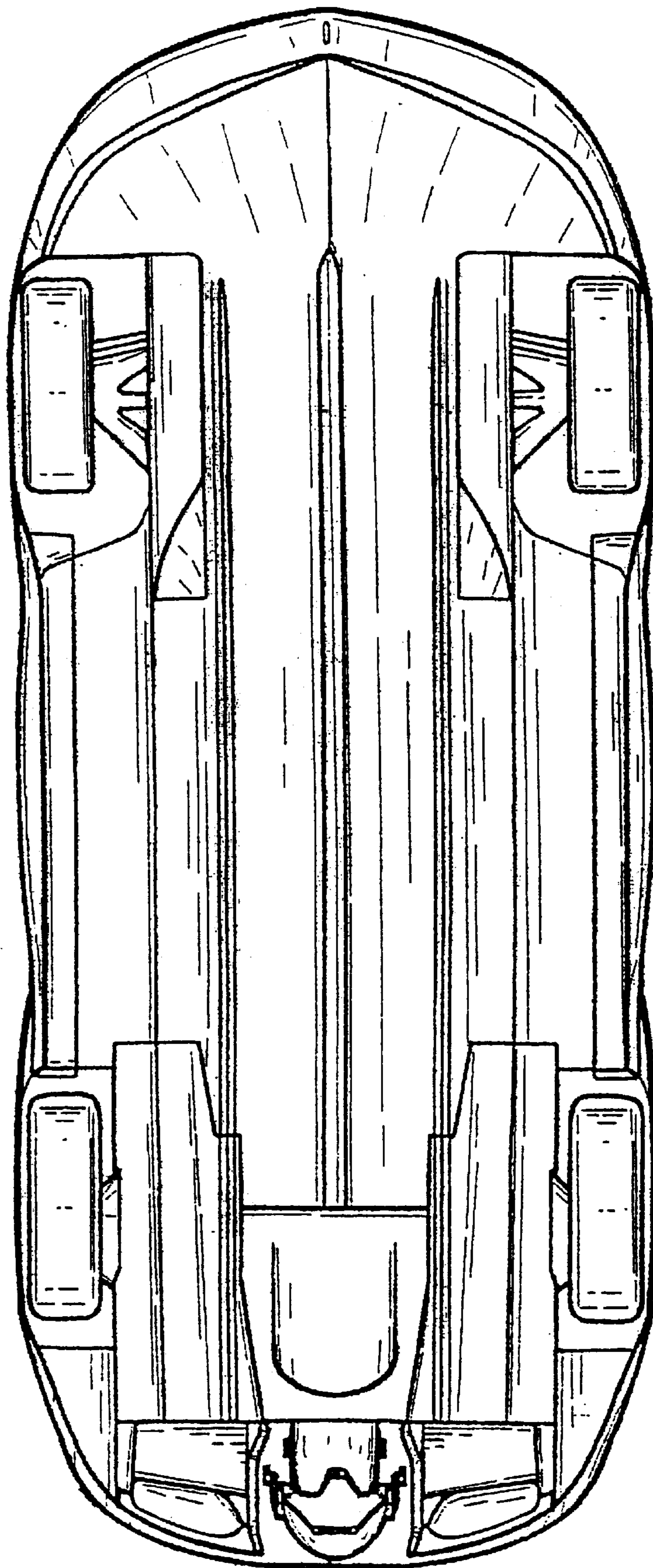

FIG - 4



FIG - 5

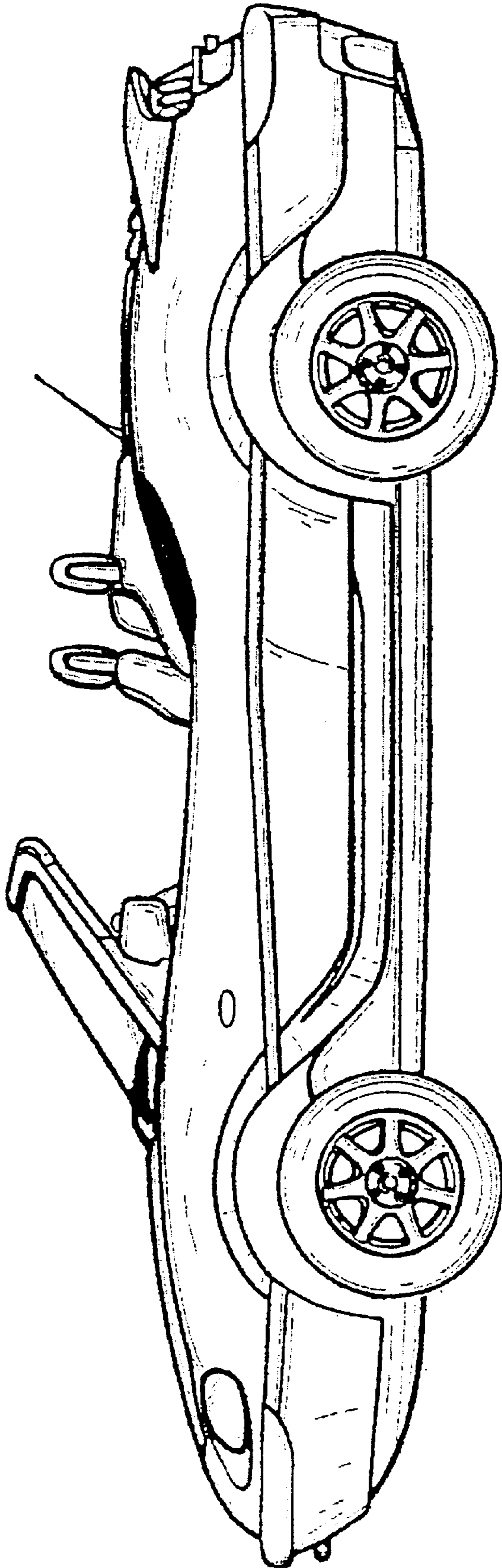
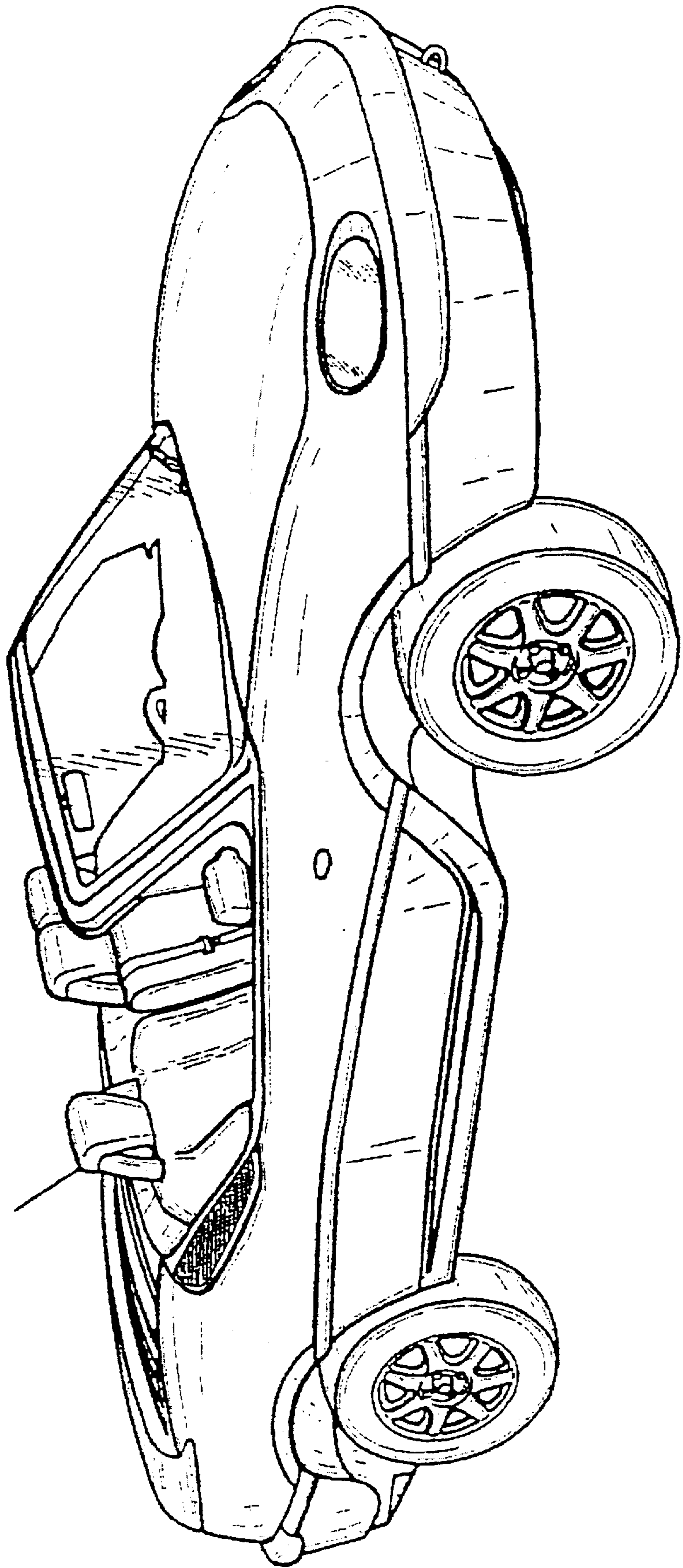



FIG - 6

FIG - 7





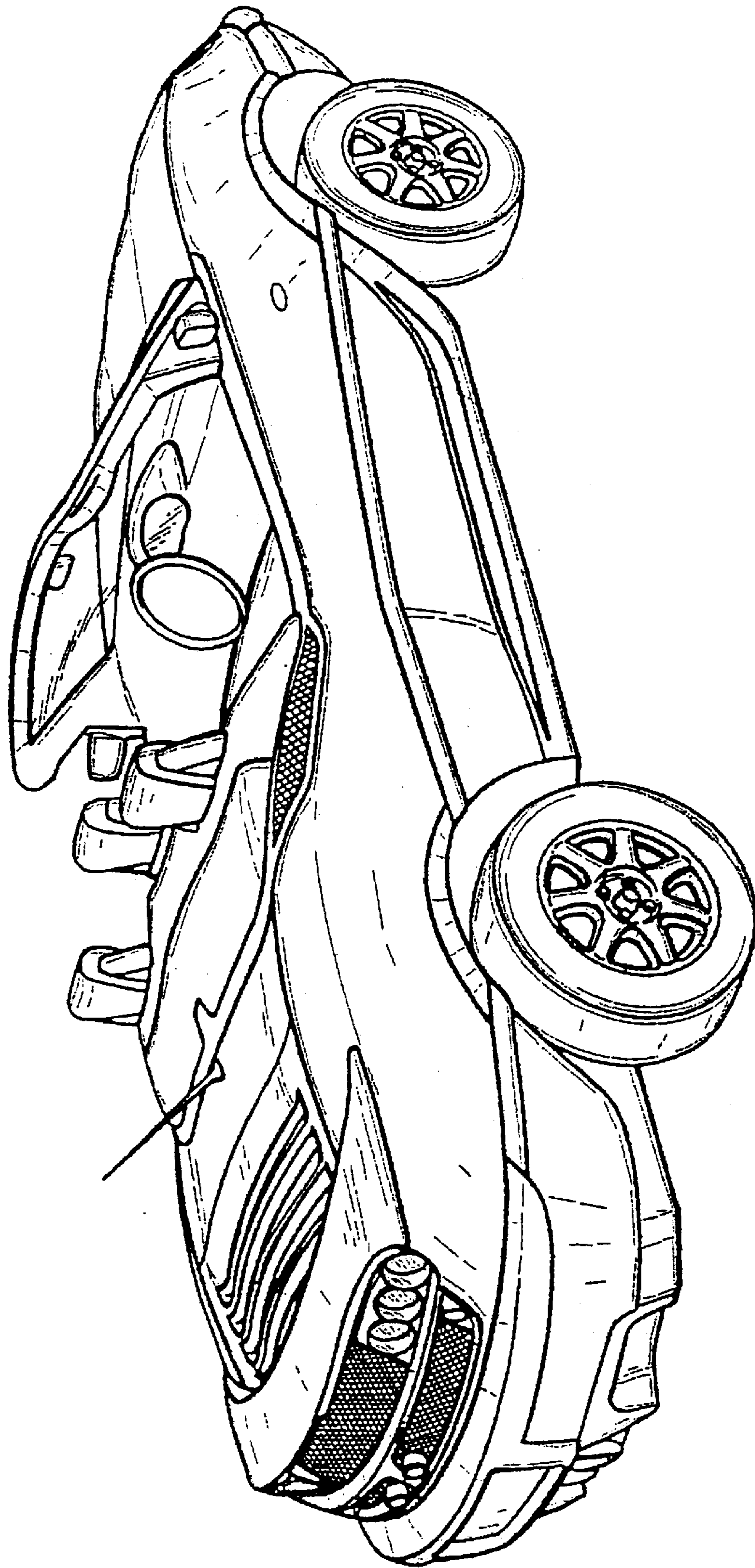
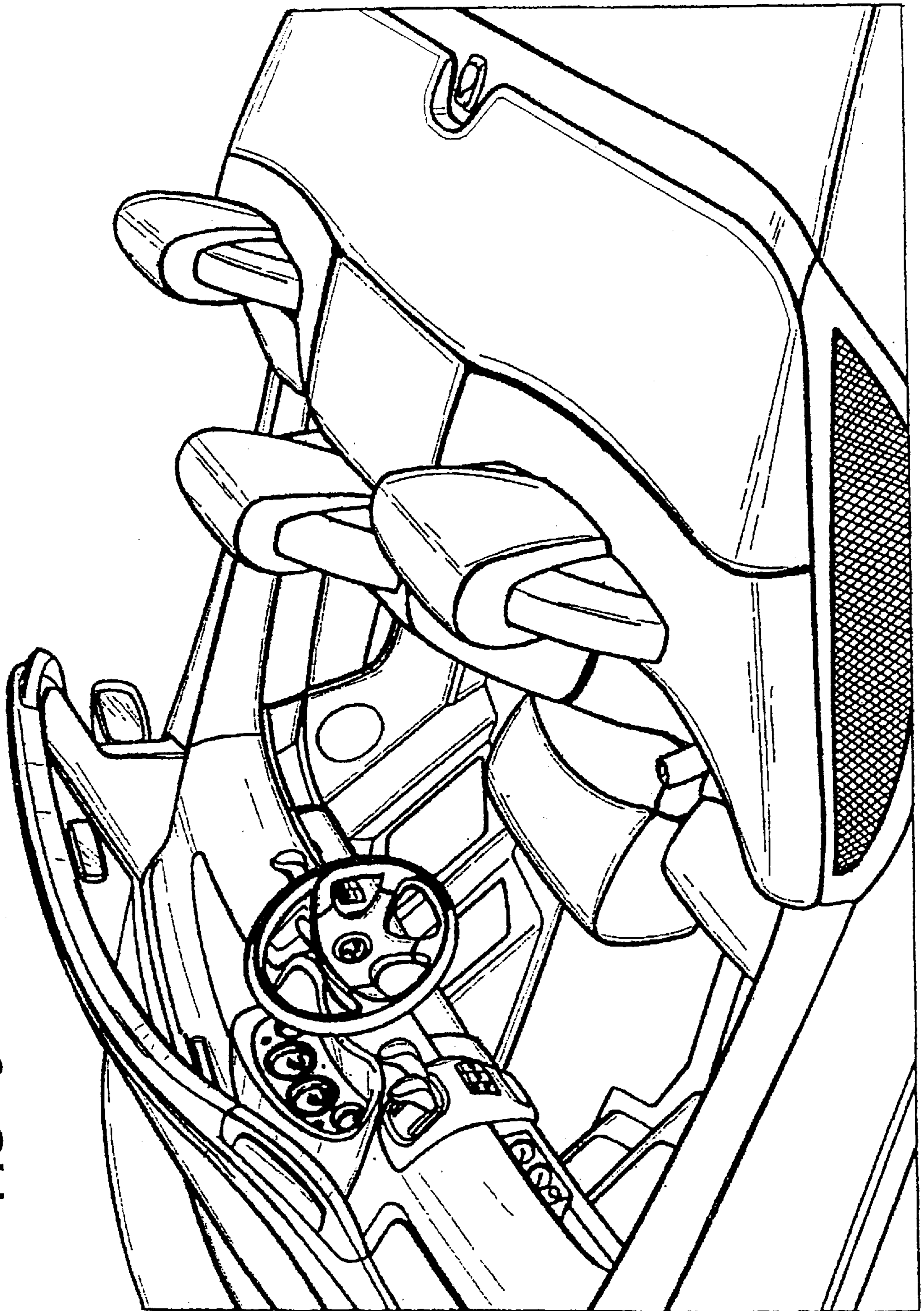

FIG - 8

FIG - 9





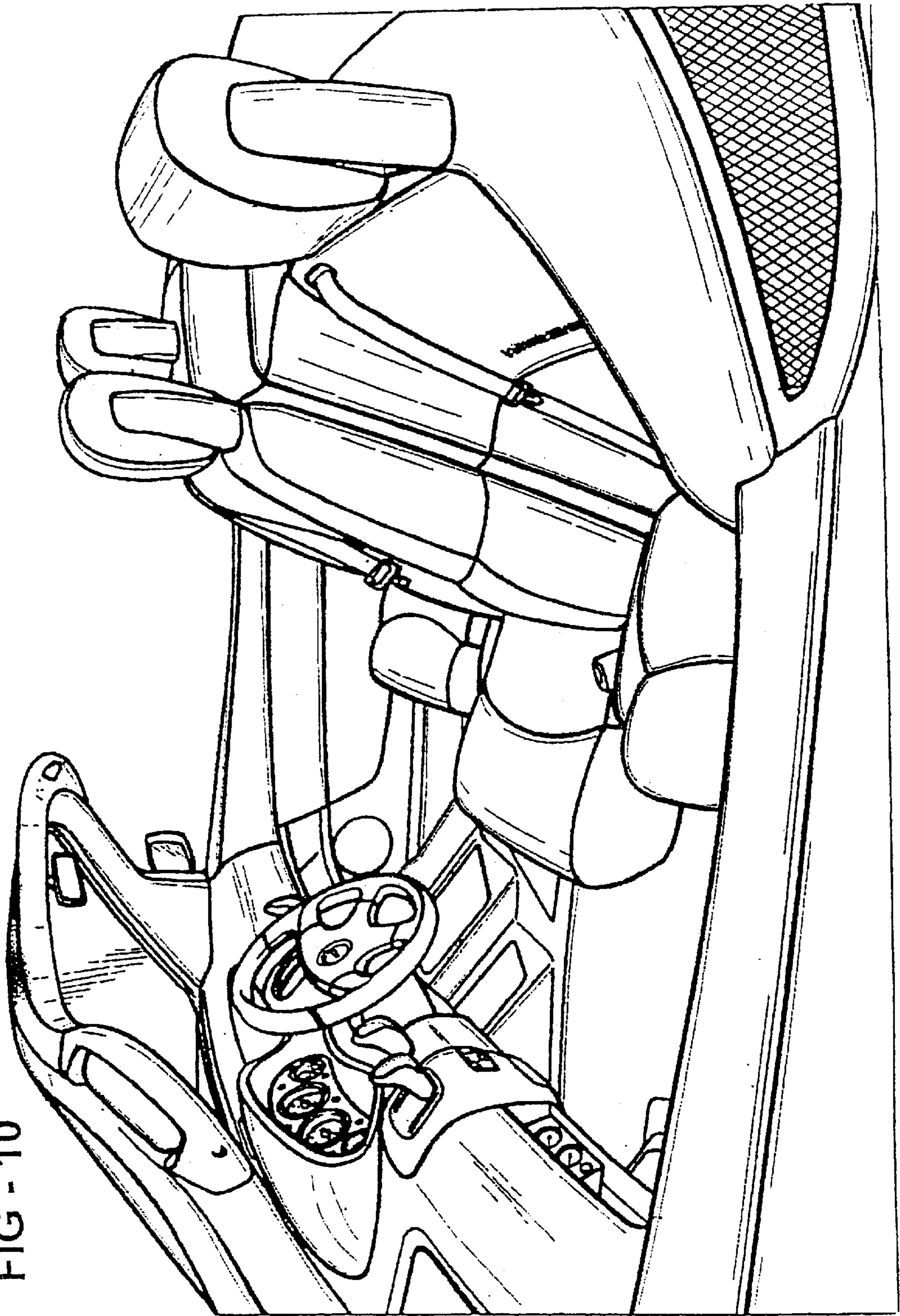

FIG - 10



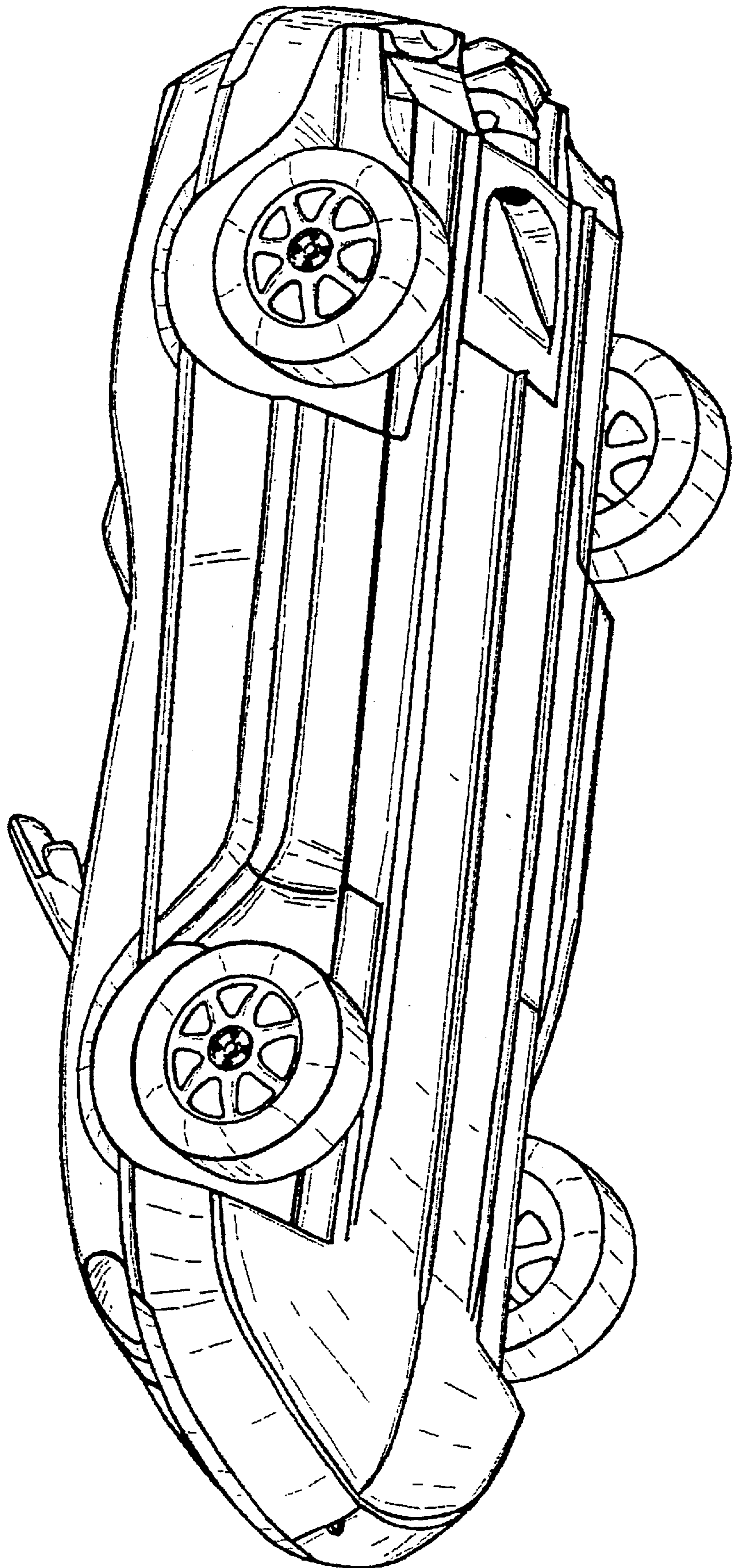
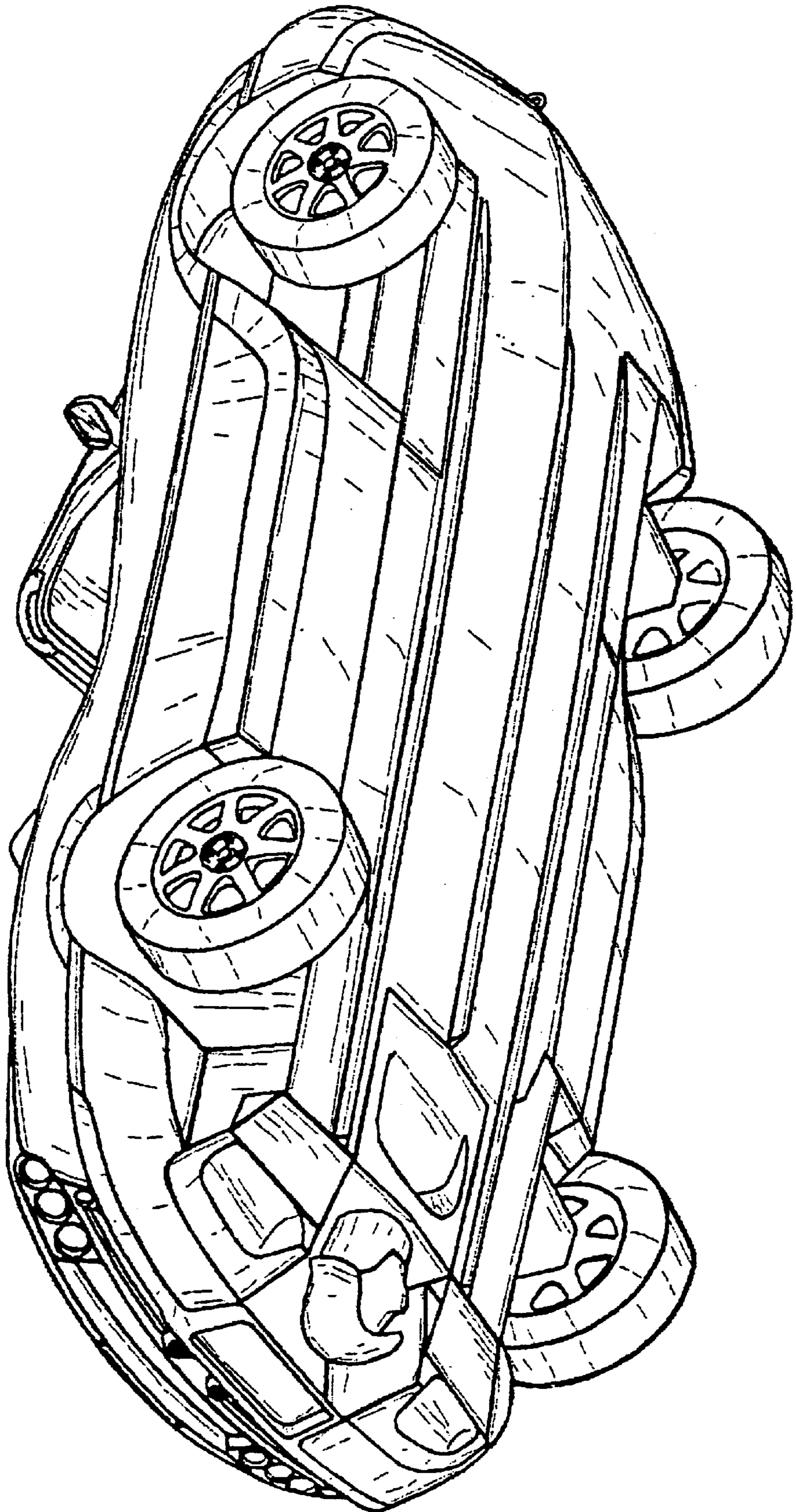

FIG - 11

FIG - 12



UNITED STATES PATENT AND TRADEMARK OFFICE  
**CERTIFICATE OF CORRECTION**

PATENT NO. : Des. 476,270 S  
DATED : June 24, 2003  
INVENTOR(S) : Stephen J. Bailey

Page 1 of 1

It is certified that error appears in the above-identified patent and that said Letters Patent is hereby corrected as shown below:

Title page,

Item [73], Assignee, "**Gibbs International Technologies Limited**" should read  
-- **Gibbs Technologies Limited** --

Signed and Sealed this

Fourth Day of November, 2003

A handwritten signature in black ink, appearing to read "James E. Rogan", with a horizontal line drawn underneath it.

JAMES E. ROGAN  
*Director of the United States Patent and Trademark Office*