



US00D476244S

(12) **United States Design Patent**
Lee

(10) **Patent No.:** **US D476,244 S**

(45) **Date of Patent:** **** Jun. 24, 2003**

(54) **TAPE MEASURE**

D458,163 S * 6/2002 Kang D10/72

* cited by examiner

(76) Inventor: **Shin-Lin Lee**, 1F, No. 22, Lane81,
Sec.2, Tunha S Rd., Taipei (TW)

Primary Examiner—Antoine Duval Davis
(74) *Attorney, Agent, or Firm*—Troxell Law Office PLLC

(**) Term: **14 Years**

(57) **CLAIM**

(21) Appl. No.: **29/163,541**

The ornamental design for a tape measure, as shown.

(22) Filed: **Jul. 9, 2002**

DESCRIPTION

(51) **LOC (7) Cl.** **10-04**

FIG. 1 is a front right perspective view of a tape measure showing my new design;

(52) **U.S. Cl.** **D10/72**

FIG. 2 is a front perspective view thereof;

(58) **Field of Search** D10/72; 33/755-770;
242/379, 405

FIG. 3 is a rear perspective view thereof;

FIG. 4 is a left side elevation view thereof;

FIG. 5 is a right side elevation view thereof;

FIG. 6 is a top plan view thereof; and,

FIG. 7 is a bottom plan view thereof.

(56) **References Cited**

U.S. PATENT DOCUMENTS

4,189,107 A * 2/1980 Quenot et al. D10/72 X

1 Claim, 4 Drawing Sheets

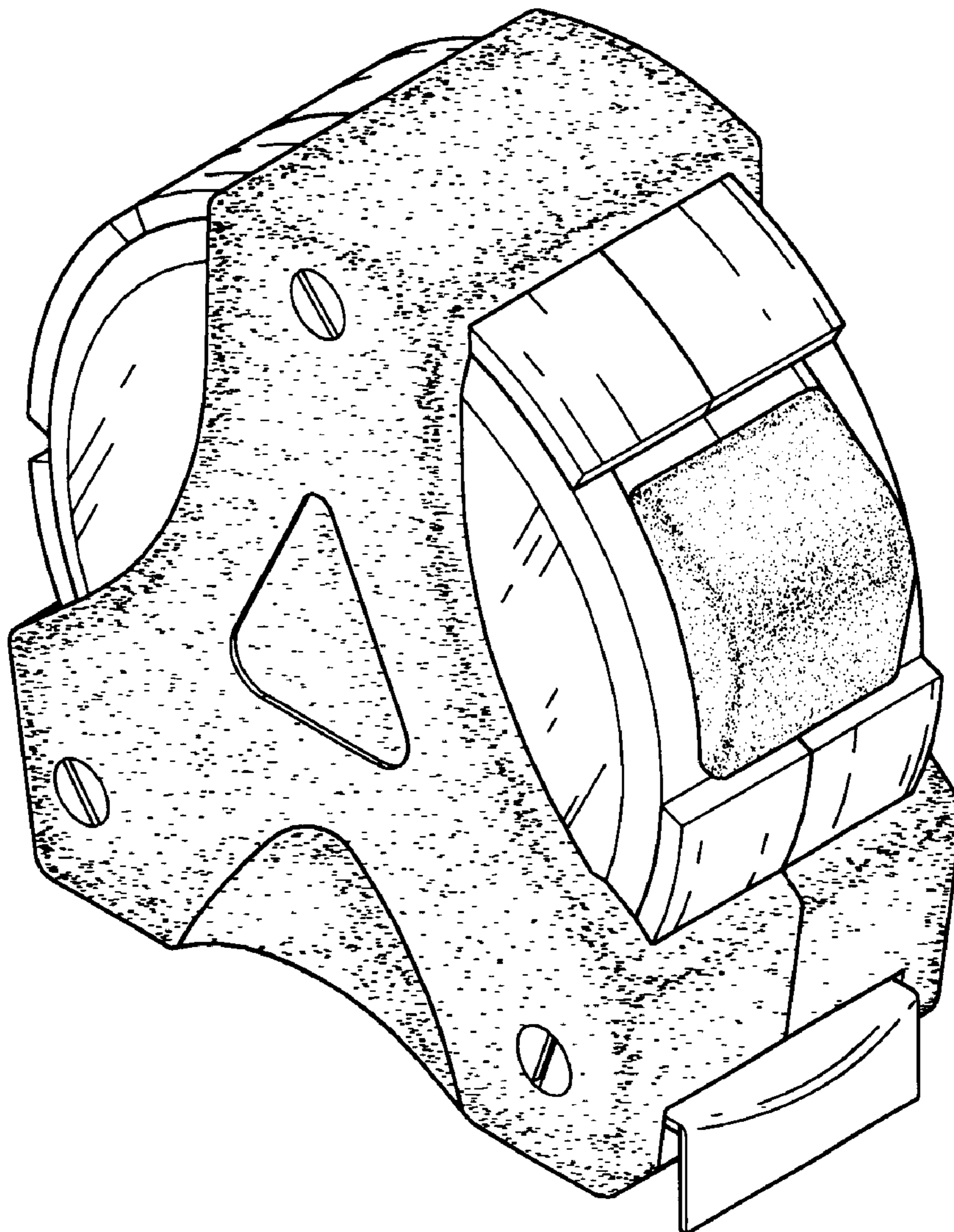

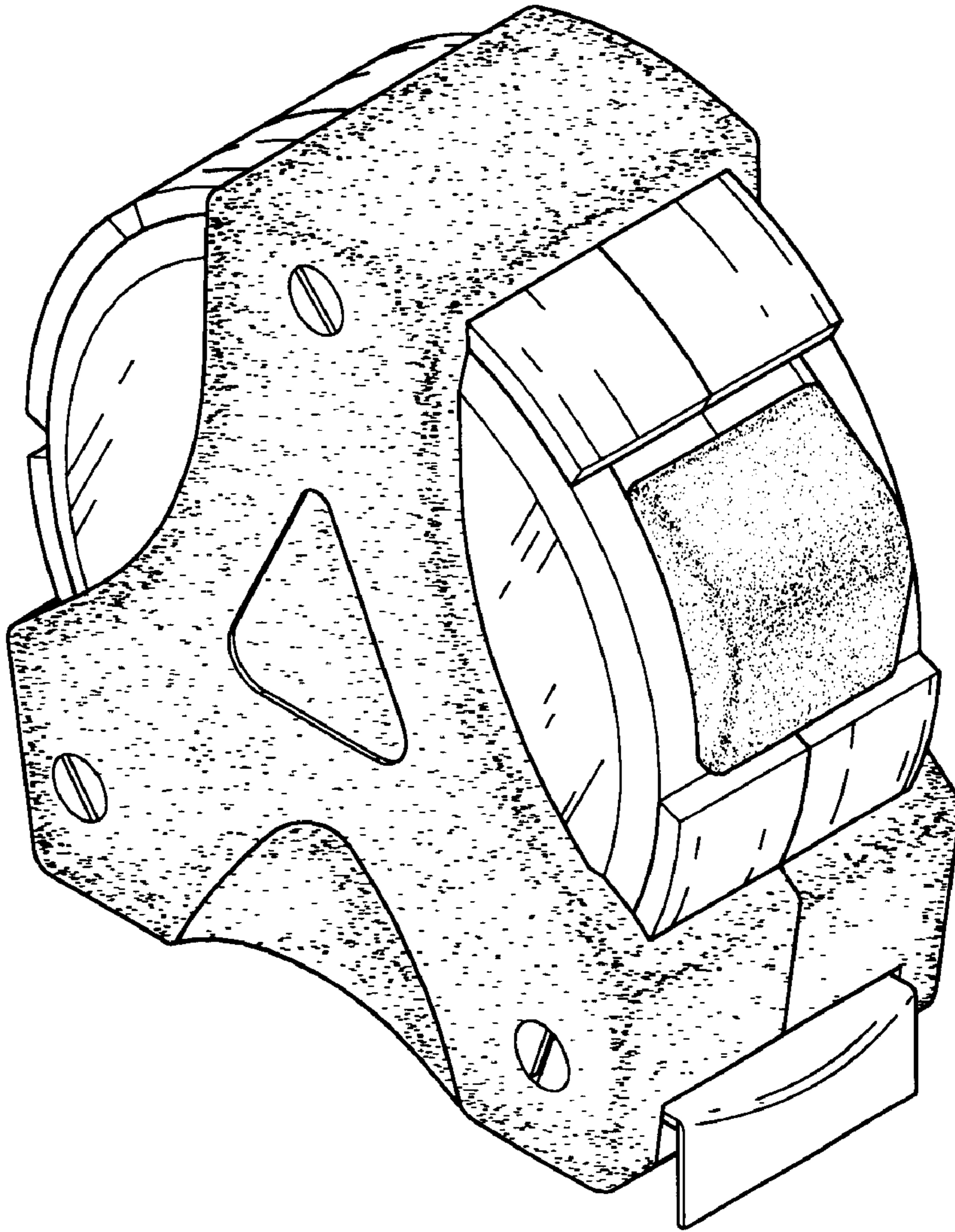

FIG. 1

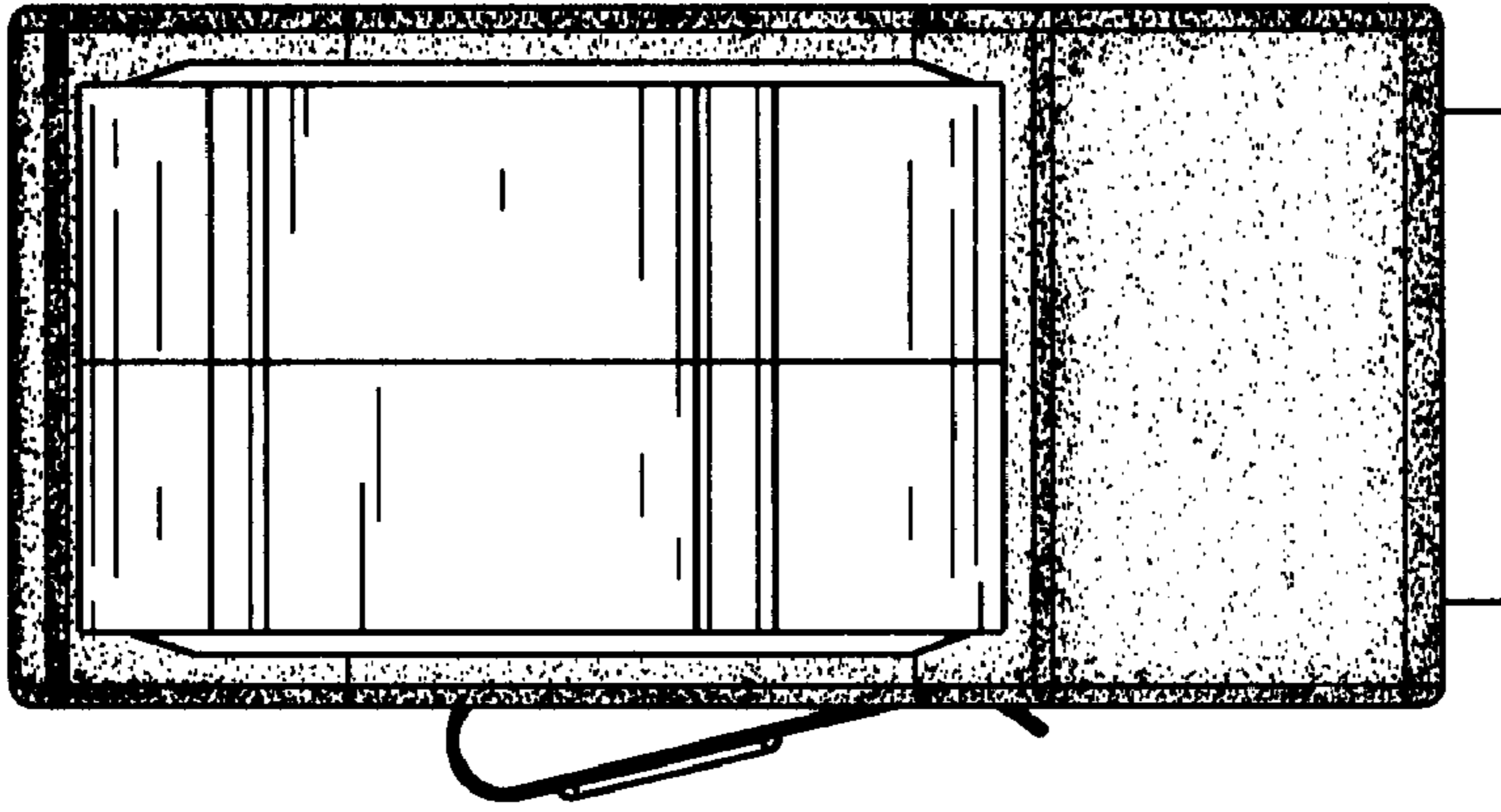

FIG. 3

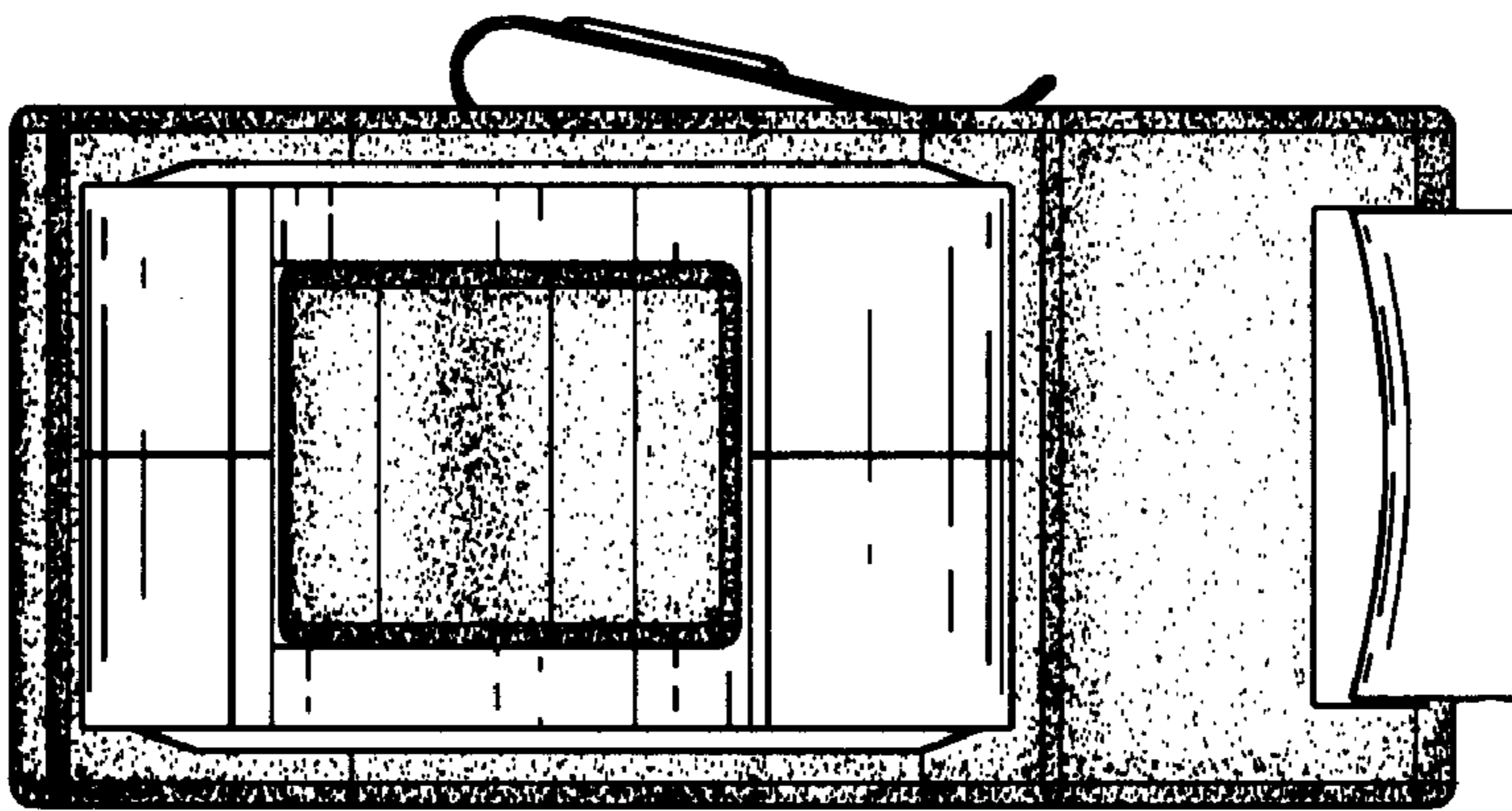

FIG. 2

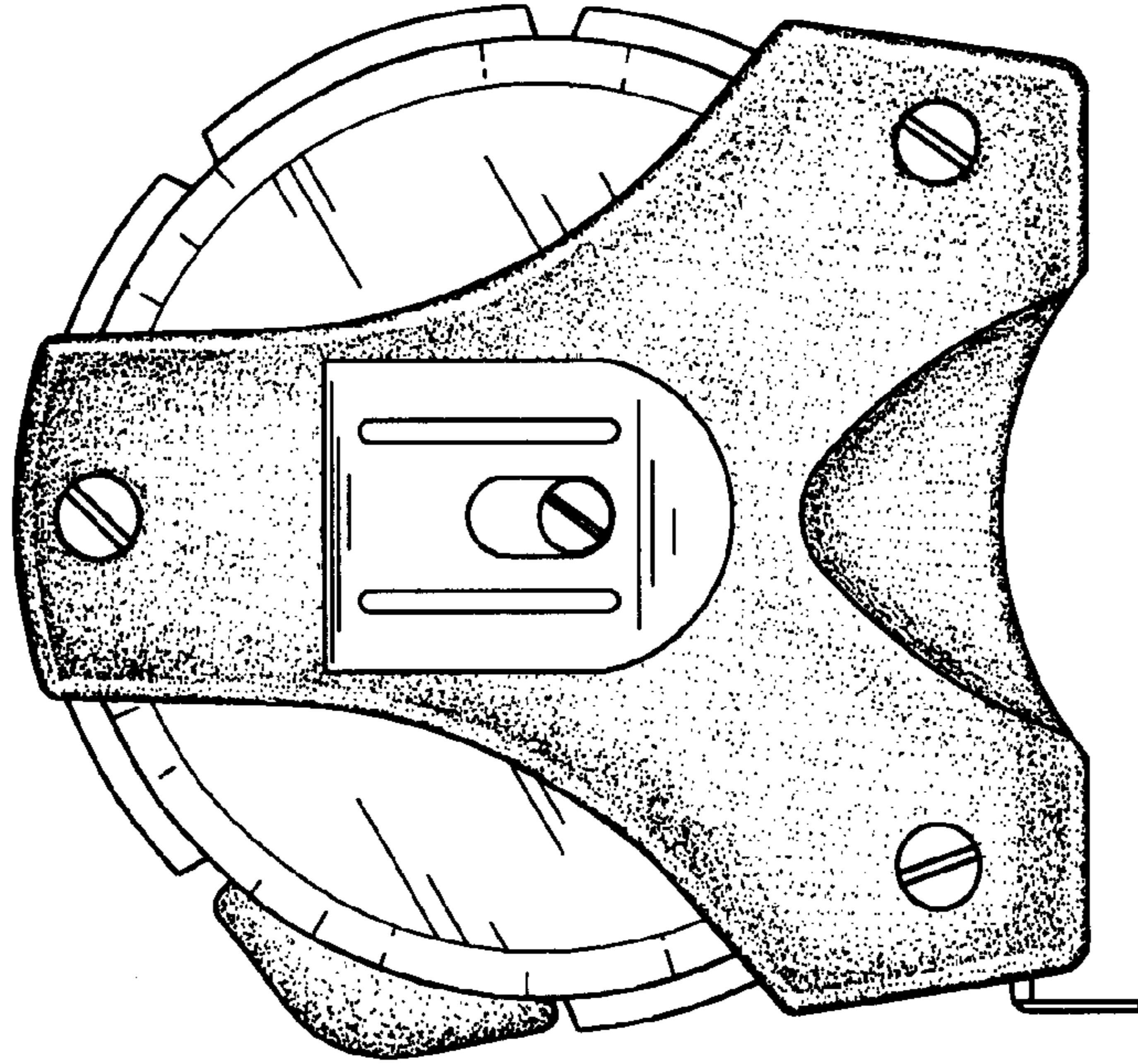

FIG. 5

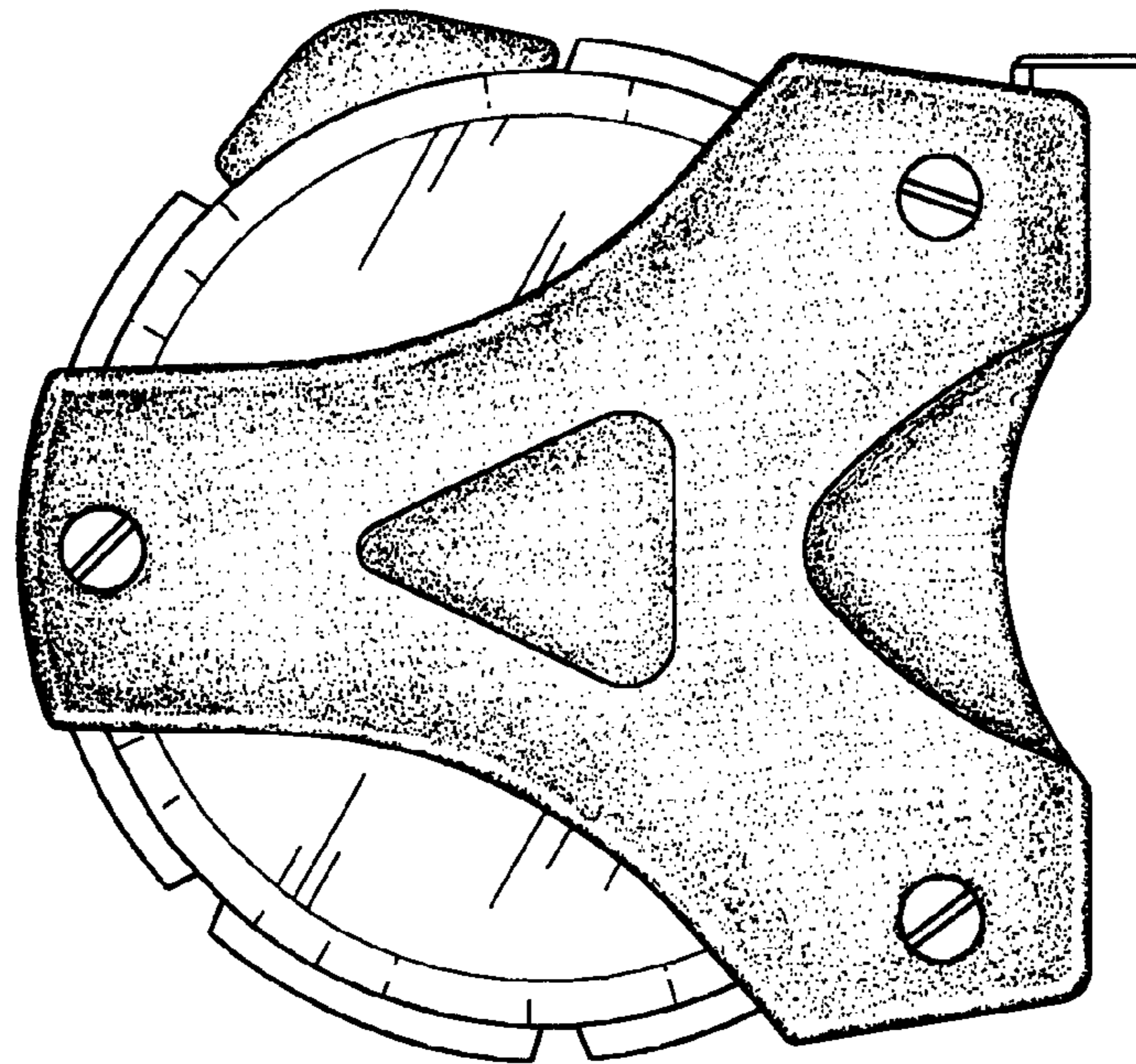

FIG. 4

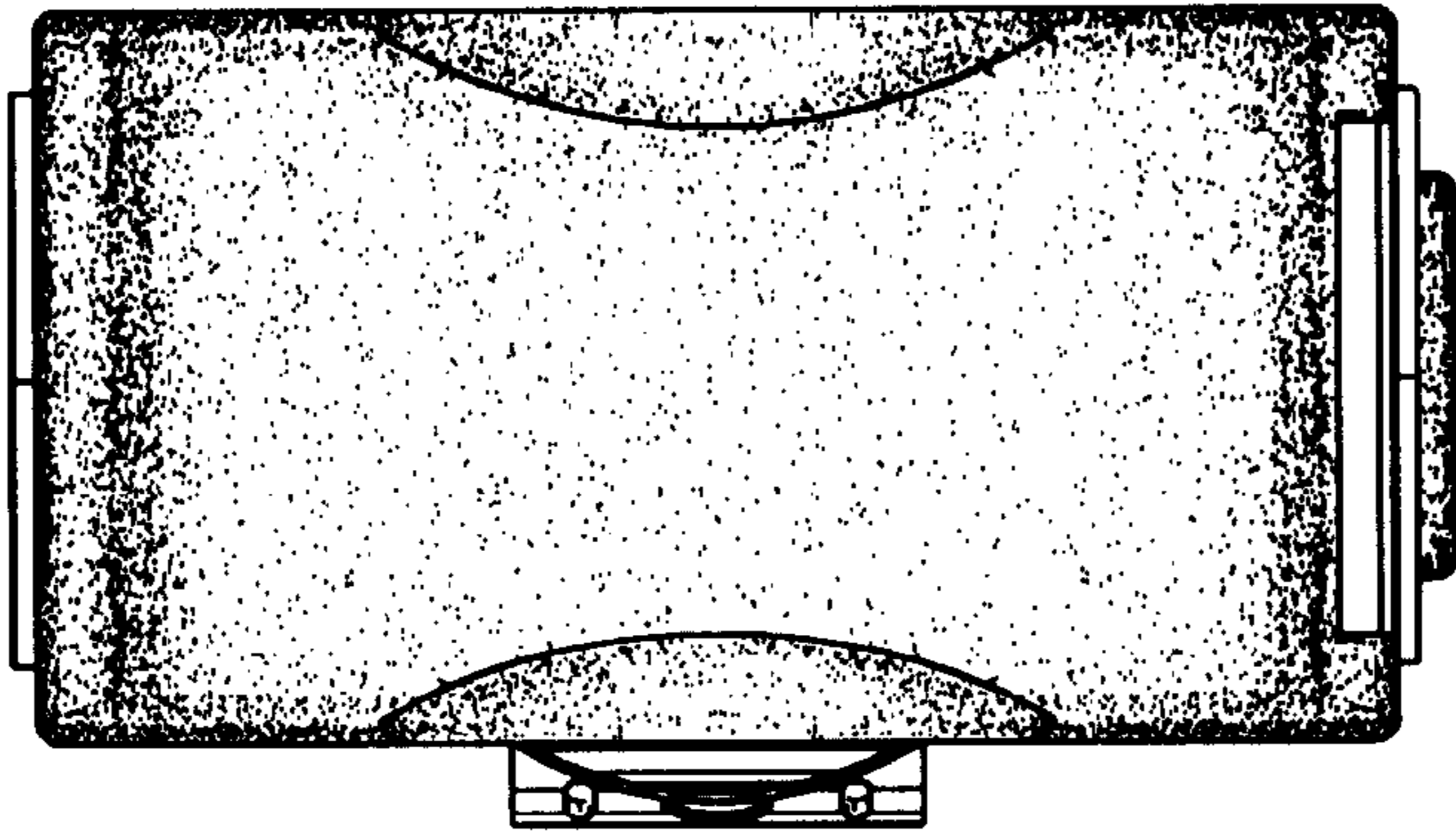

FIG. 7

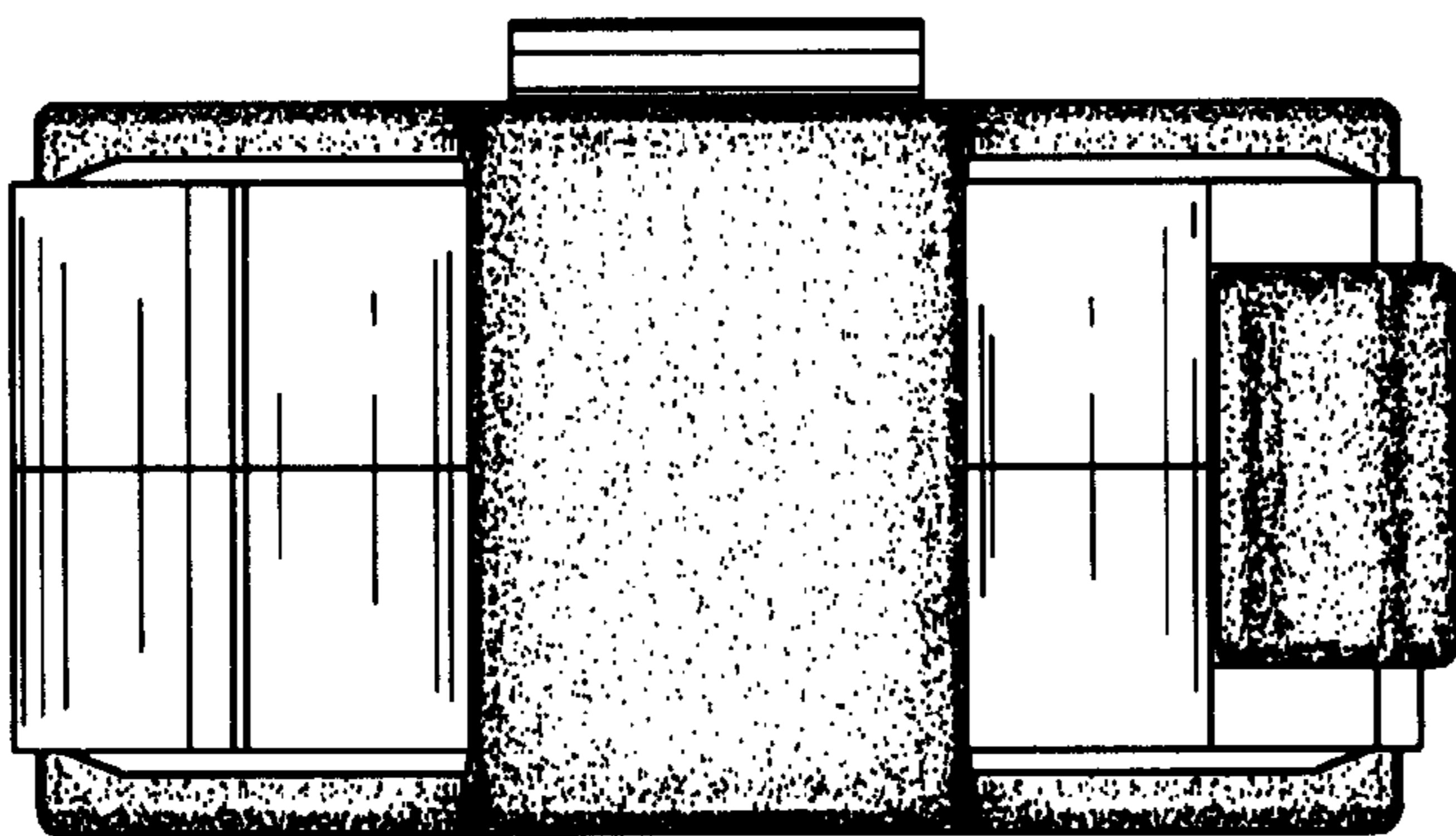

FIG. 6