



US00D476237S

(12) **United States Design Patent**  
**Canepa**

(10) **Patent No.:** **US D476,237 S**

(45) **Date of Patent:** **\*\* Jun. 24, 2003**

(54) **BOTTLE**

(75) **Inventor:** **Sergio Cesare Canepa, Milan (IT)**

(73) **Assignee:** **Monari Federzoni S.p.A., Solara (IT)**

(\*\*) **Term:** **14 Years**

(21) **Appl. No.:** **29/154,837**

(22) **Filed:** **Jan. 30, 2002**

(30) **Foreign Application Priority Data**

Aug. 1, 2001 (IT) ..... TO200100232

(51) **LOC (7) Cl.** ..... **09-01**

(52) **U.S. Cl.** ..... **D9/545; D9/551; D9/572;**  
**D9/575; D9/550**

(58) **Field of Search** ..... **D9/500, 501-505,**  
**D9/516, 522, 537-539, 540, 541, 542, 543,**  
**544-546, 549, 550, 551, 558, 563, 564,**  
**572, 573, 574, 575; 215/382-385, 396,**  
**398, 480**

(56) **References Cited**

**U.S. PATENT DOCUMENTS**

267,924 A \* 11/1882 Paull ..... 215/382 X  
D21,192 S \* 12/1891 Van Houten ..... D9/505  
D24,670 S \* 9/1895 Sperry ..... D9/500  
D59,309 S \* 10/1921 Vidulich ..... D9/505  
1,659,383 A \* 2/1928 Thiene et al. .... 215/383 X  
1,824,229 A \* 9/1931 Pevsner ..... 215/400 X  
D211,978 S \* 8/1968 Douglas ..... D9/538 X  
D213,307 S \* 2/1969 Kneapler ..... D9/558

D232,809 S \* 9/1974 Pardo ..... D9/542  
D233,982 S \* 12/1974 De Graw ..... D9/500  
D253,337 S \* 11/1979 Bass et al. .... D9/500 X  
D268,248 S \* 3/1983 Bonnefoy ..... D9/522  
D284,980 S \* 8/1986 Yoshida ..... D19/41  
D292,377 S \* 10/1987 Borgo ..... D9/545 X  
D372,427 S \* 8/1996 Jago et al. .... D9/500  
D460,356 S \* 7/2002 Koenig ..... D9/434

**OTHER PUBLICATIONS**

Owens-Illinois Food Industries 1959 Stock Catalog,  
Owens-Illinois, Toledo, Ohio, Duraglas Containers, N/M  
Round, "Mint Sauce mold #E-1294", p. 42, top left corner  
of page.\*

\* cited by examiner

*Primary Examiner*—Ted Shooman

*Assistant Examiner*—Carol Rademaker

(74) *Attorney, Agent, or Firm*—Merchant & Gould P.C.

(57) **CLAIM**

The ornamental design for a bottle, as shown and described.

**DESCRIPTION**

FIG. 1 is a perspective view of the bottle showing my new  
design;

FIG. 2 is a front view thereof;

FIG. 3 is a right view thereof;

FIG. 4 is a left view thereof;

FIG. 5 is a rear view thereof;

FIG. 6 is a top view thereof; and,

FIG. 7 is a bottom view thereof.

**1 Claim, 2 Drawing Sheets**

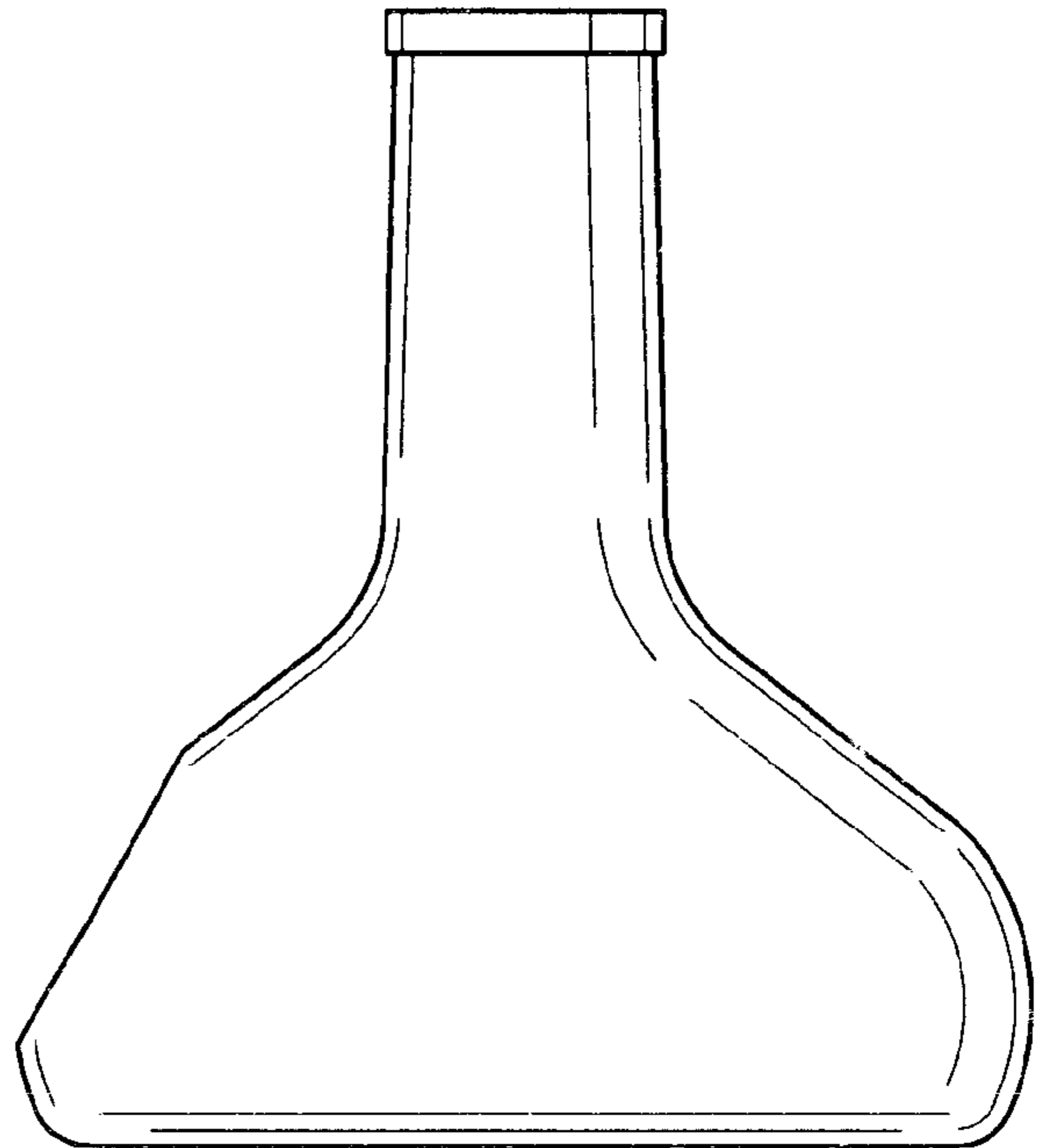
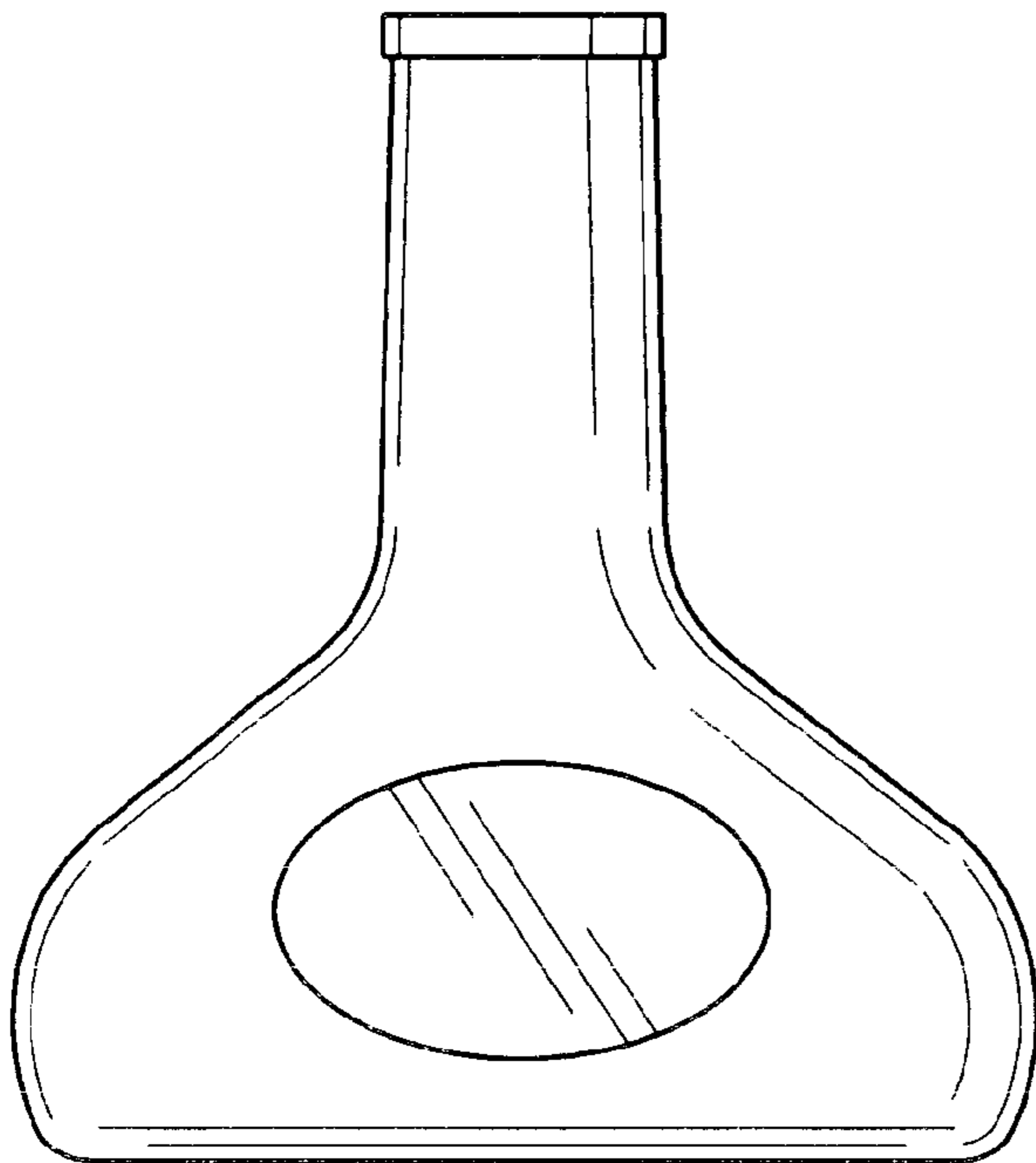

FIG. 1

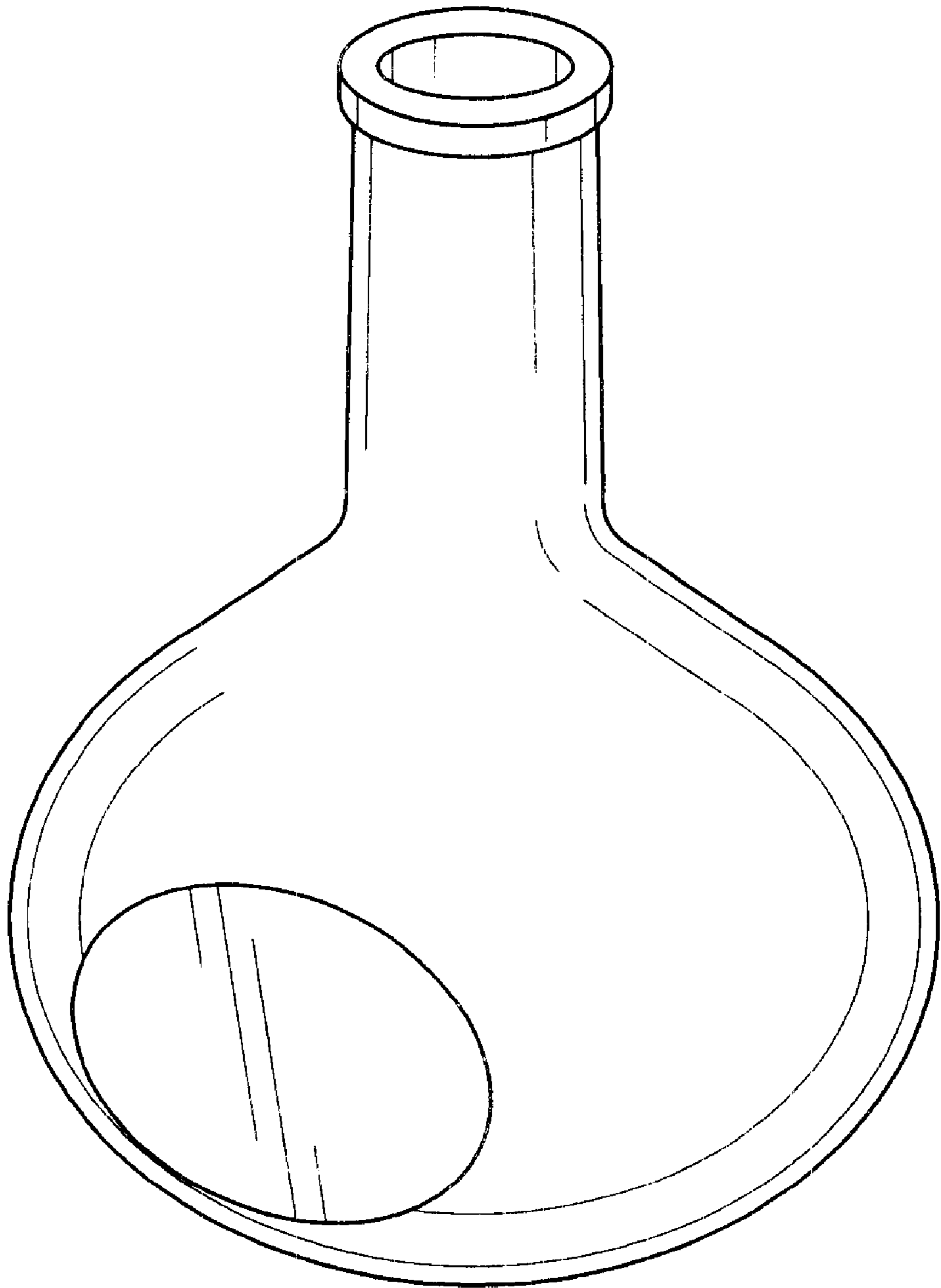

FIG.2

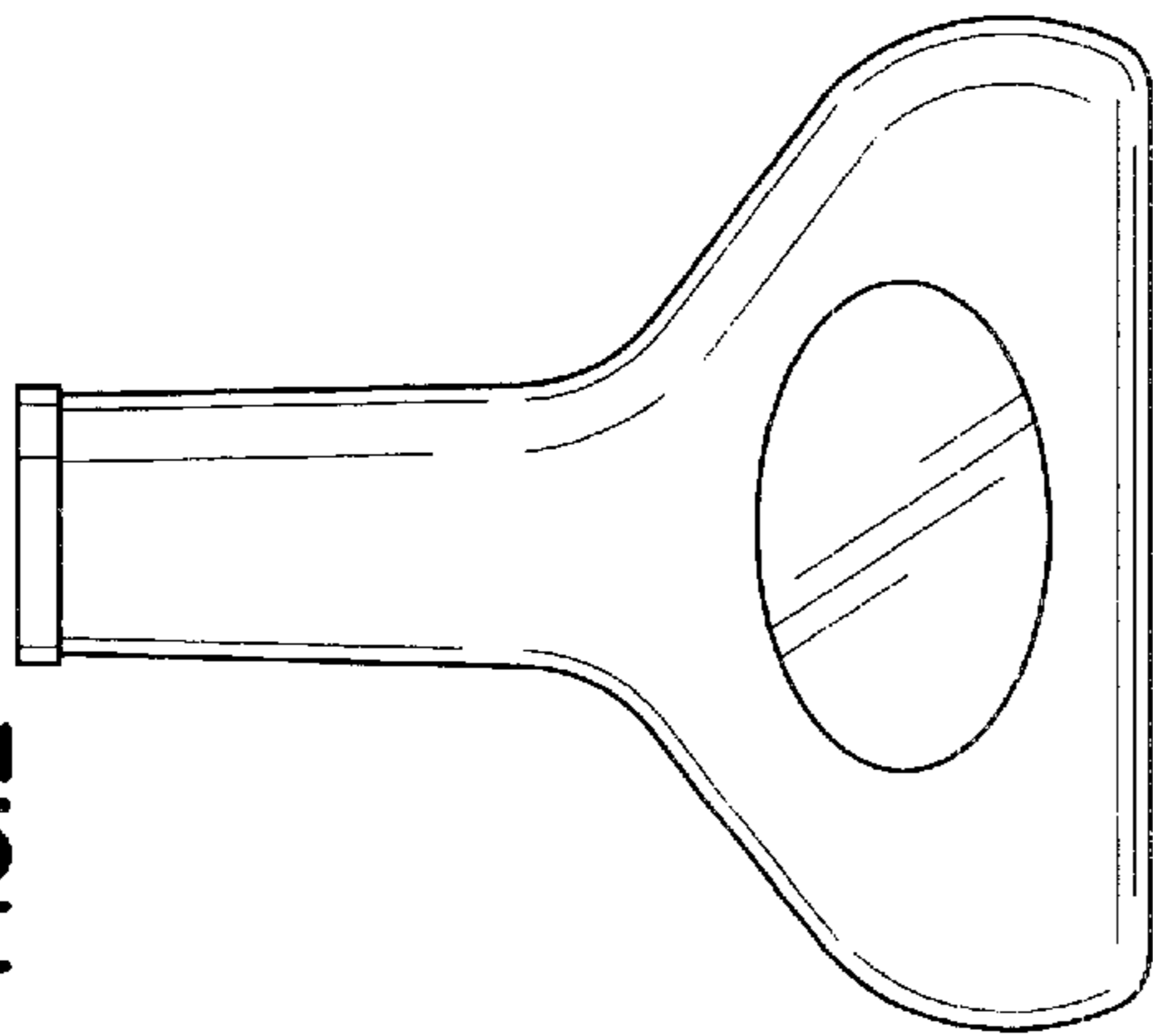

FIG.3

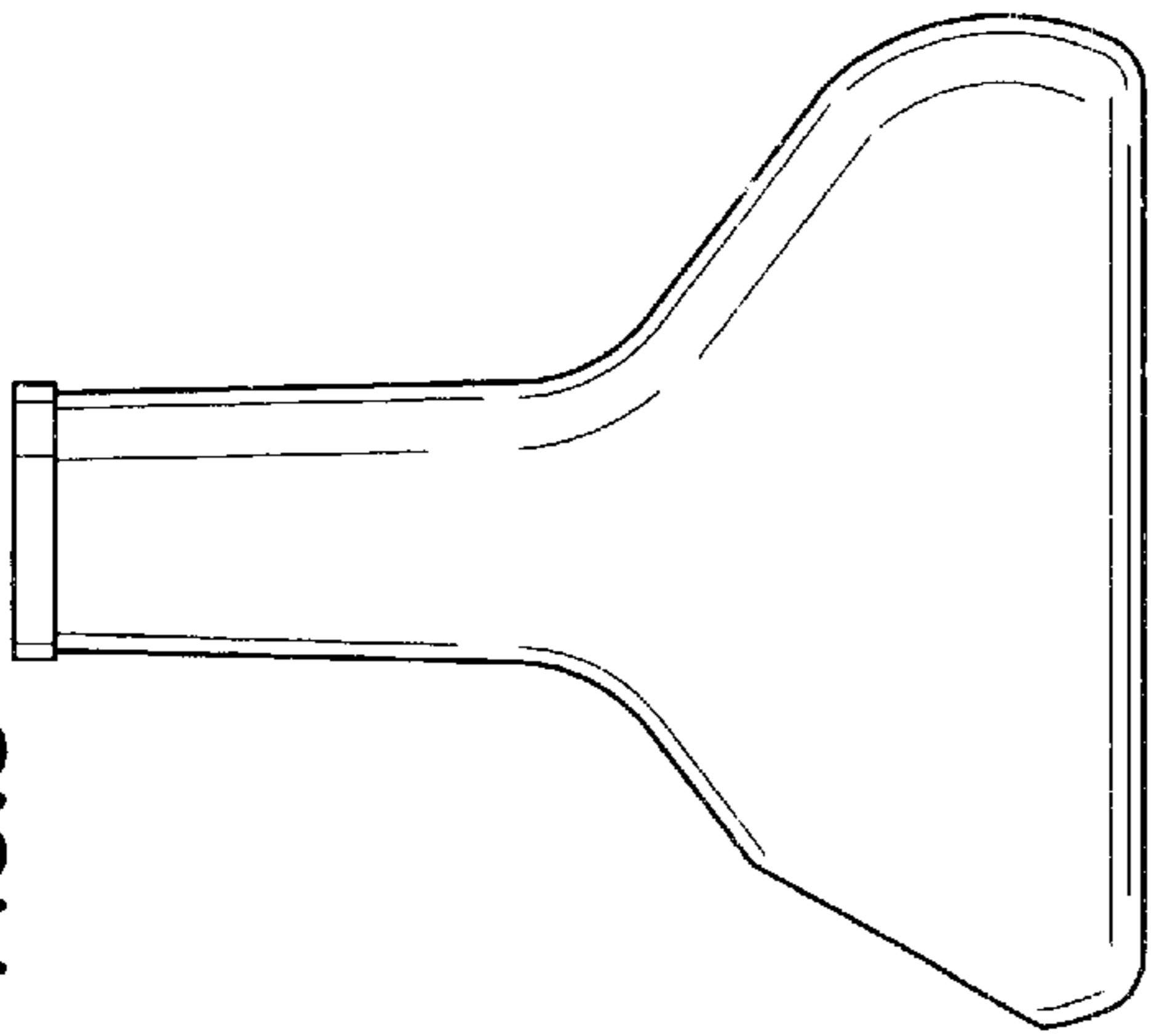

FIG.4

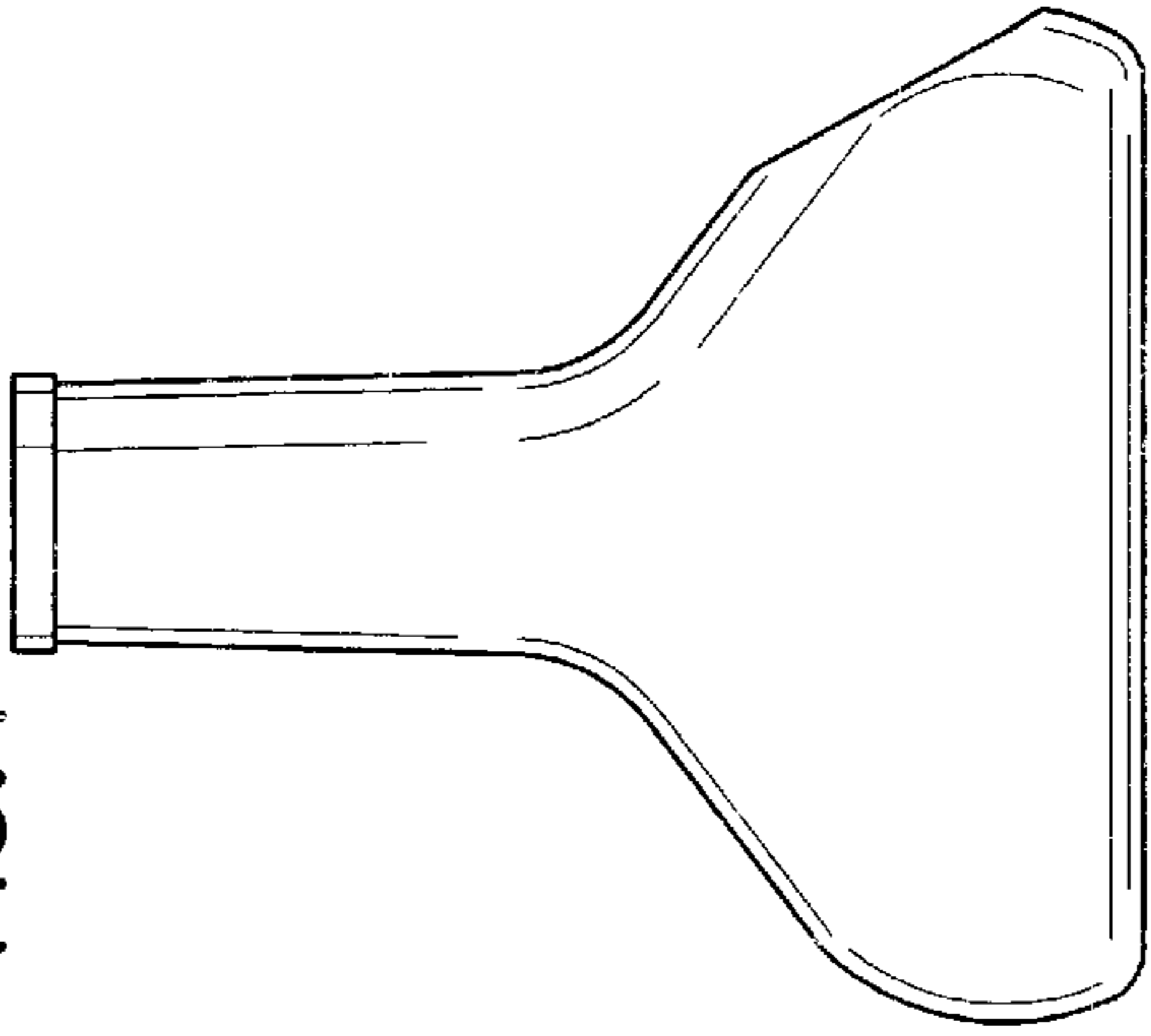

FIG.5

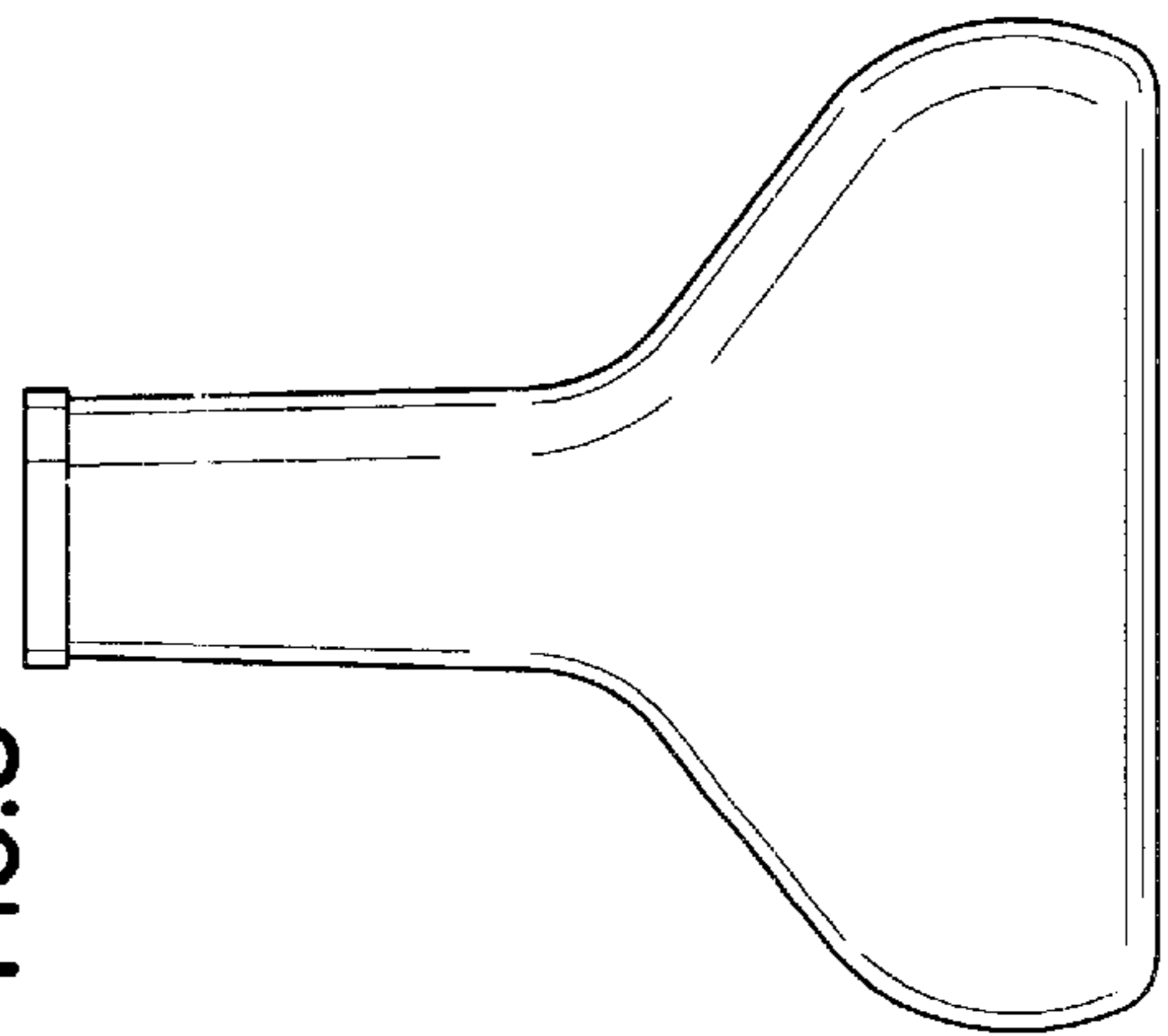

FIG.6

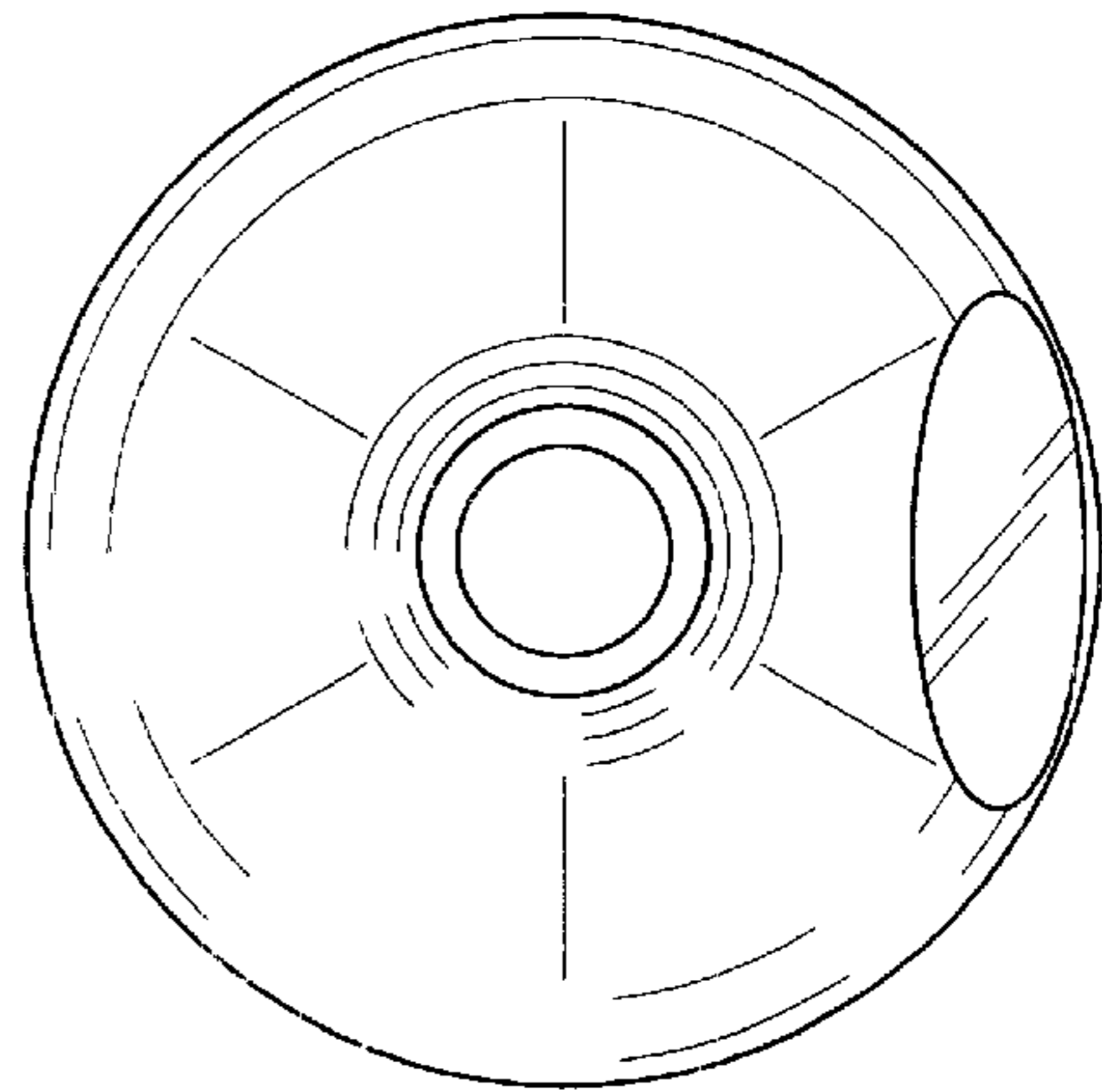

FIG.7

