



US00D476032S

(12) **United States Design Patent**
Marchand

(10) **Patent No.:** **US D476,032 S**

(45) **Date of Patent:** **** Jun. 17, 2003**

(54) **NOTEBOOK**

(75) **Inventor:** **Emmanuel Marchand**, Los Altos, CA (US)

(73) **Assignee:** **Chameleon Books & Journals, Inc.**, Gilroy, CA (US)

(**) **Term:** **14 Years**

(21) **Appl. No.:** **29/169,672**

(22) **Filed:** **Oct. 23, 2002**

(51) **LOC (7) Cl.** **19-04**

(52) **U.S. Cl.** **D19/26; D3/303**

(58) **Field of Search** D3/303, 900; D19/26, D19/27, 32, 33, 75, 86, 65; 281/15.1, 19.1, 21.1, 29, 30, 31, 32, 35, 34, 45, 48, 51; 283/36, 37, 42, 48.1, 52.1, 55, 63.1, 64, 117; 402/4, 73, 79, 80 R; 229/67.1-67.4, 117.09, 928

(56) **References Cited**

U.S. PATENT DOCUMENTS

- 254,880 A * 3/1882 Lovett 283/55 X
- 704,734 A * 7/1902 Brugerolles 281/45
- 1,734,642 A * 11/1929 Olm 229/67.3

- 2,275,956 A * 3/1942 Grace 283/63.1 X
- 2,354,782 A * 8/1944 Stradling et al. 281/16
- 3,312,384 A * 4/1967 Heynemann 229/117.09 X
- 4,296,945 A * 10/1981 Pavlik 281/51
- 5,236,226 A * 8/1993 Sheffield 281/48
- 5,695,233 A 12/1997 Feldman 294/138
- 5,797,630 A * 8/1998 Conley, Jr. 281/15.1
- D399,058 S * 10/1998 Wyant D3/303

* cited by examiner

Primary Examiner—Martie K. Holtje

(74) *Attorney, Agent, or Firm*—Thomas Schneck; Gina McCarthy

(57) **CLAIM**

The ornamental design for a notebook, as shown.

DESCRIPTION

FIG. 1 is a perspective view of a notebook according to my design;
 FIG. 2 is a front view of the notebook shown in FIG. 1;
 FIG. 3 is a right side view thereof;
 FIG. 4 is a rear view thereof;
 FIG. 5 is a left side view thereof;
 FIG. 6 is a top view thereof; and,
 FIG. 7 is a bottom view thereof.

1 Claim, 4 Drawing Sheets

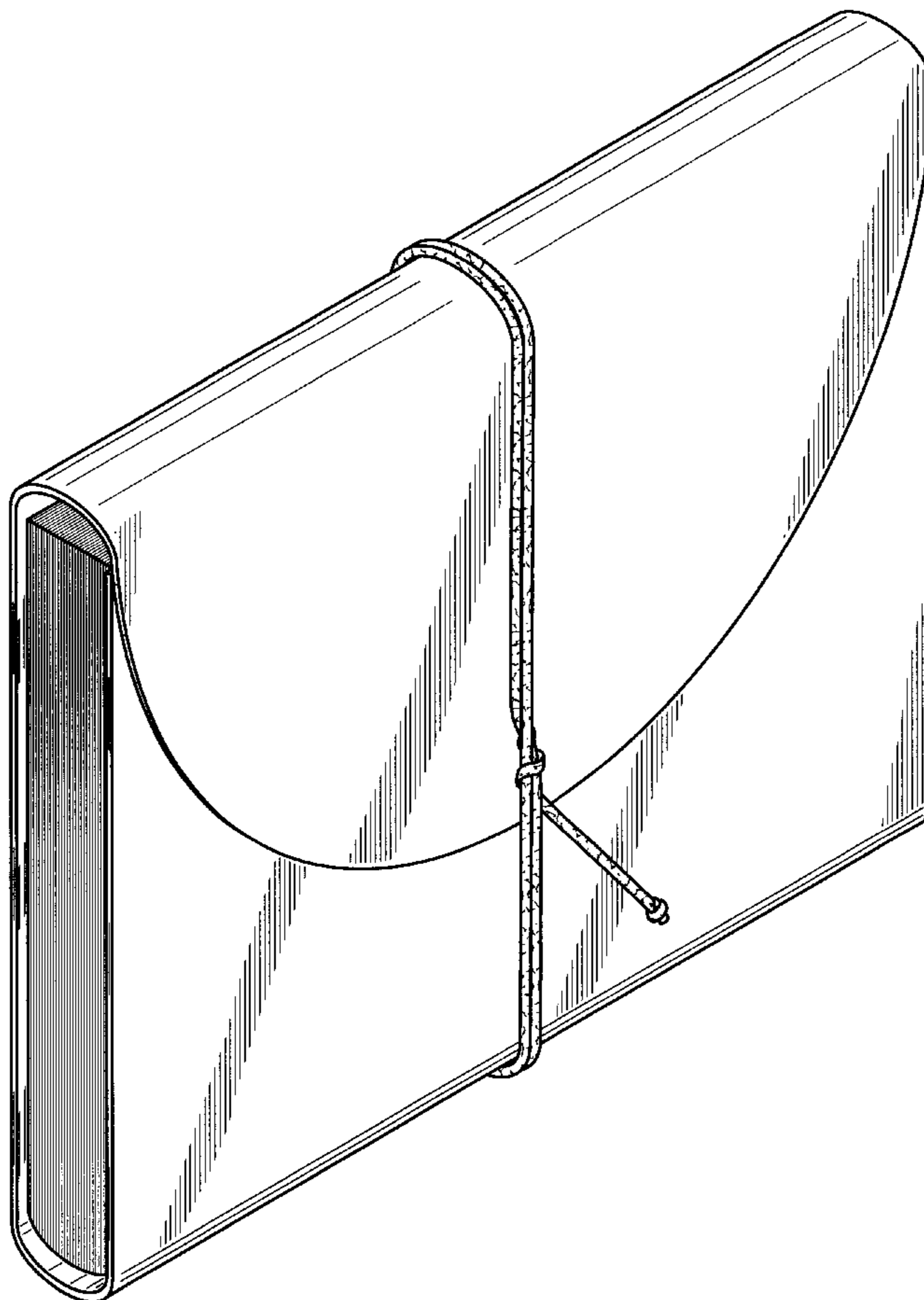

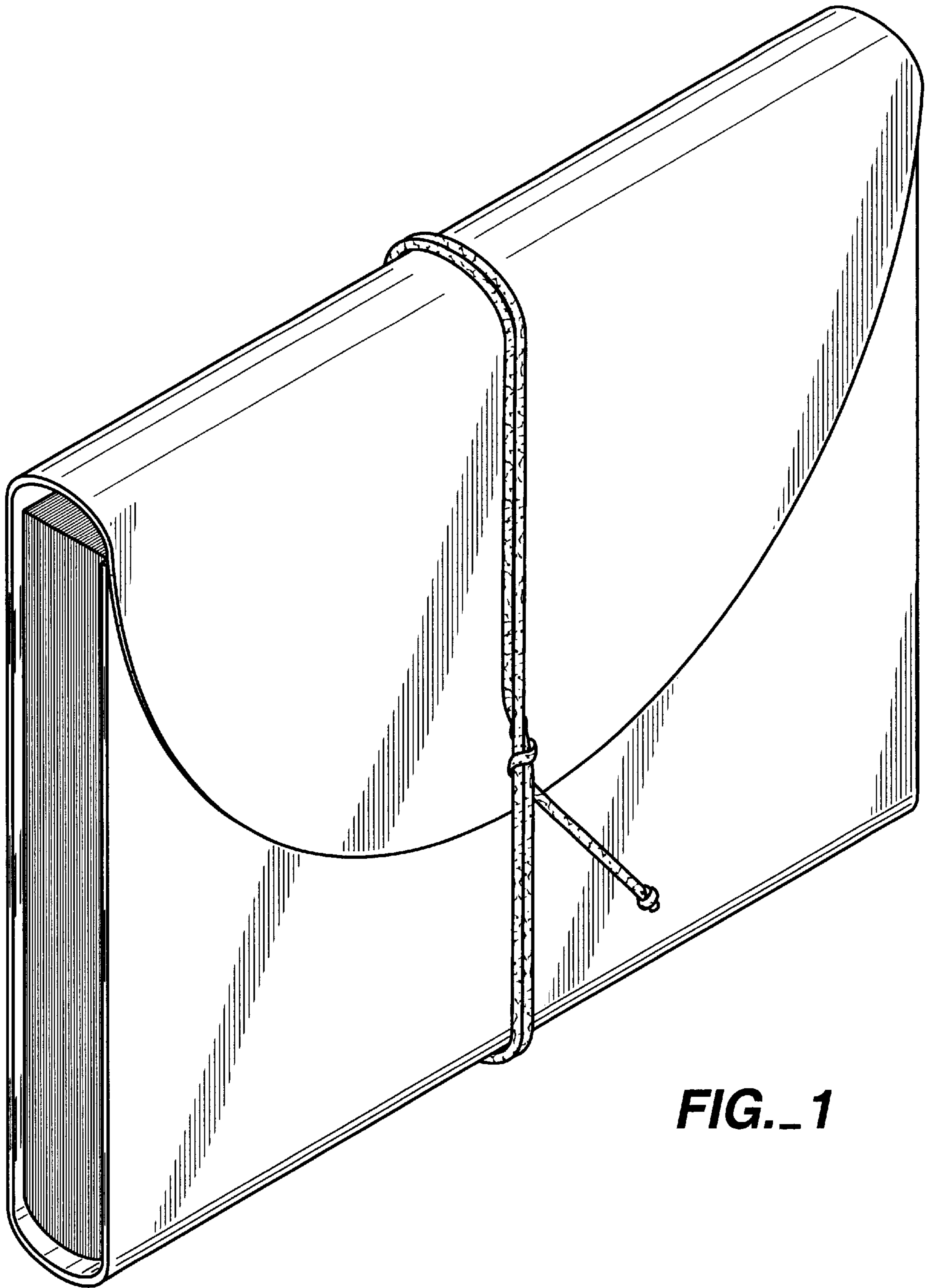

FIG. 1

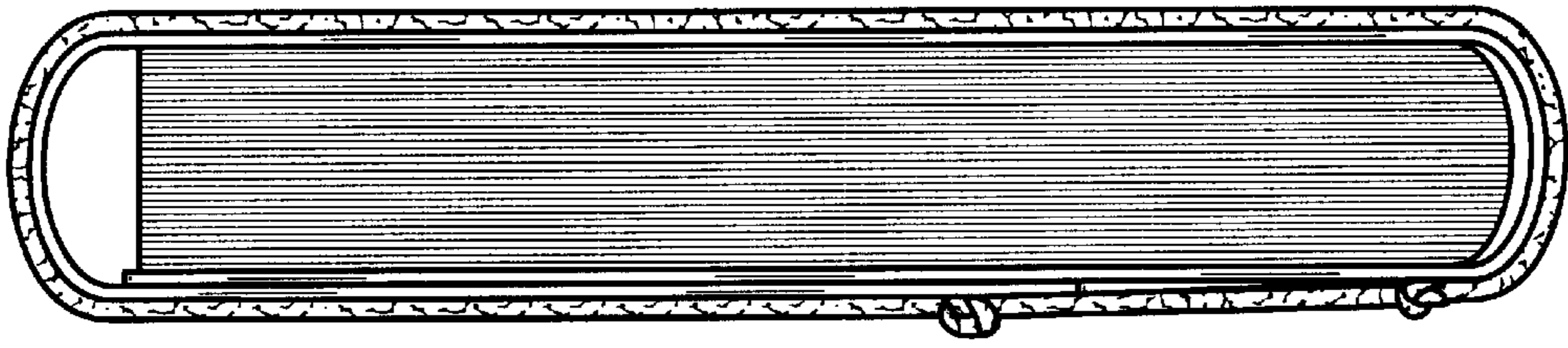

FIG.-3

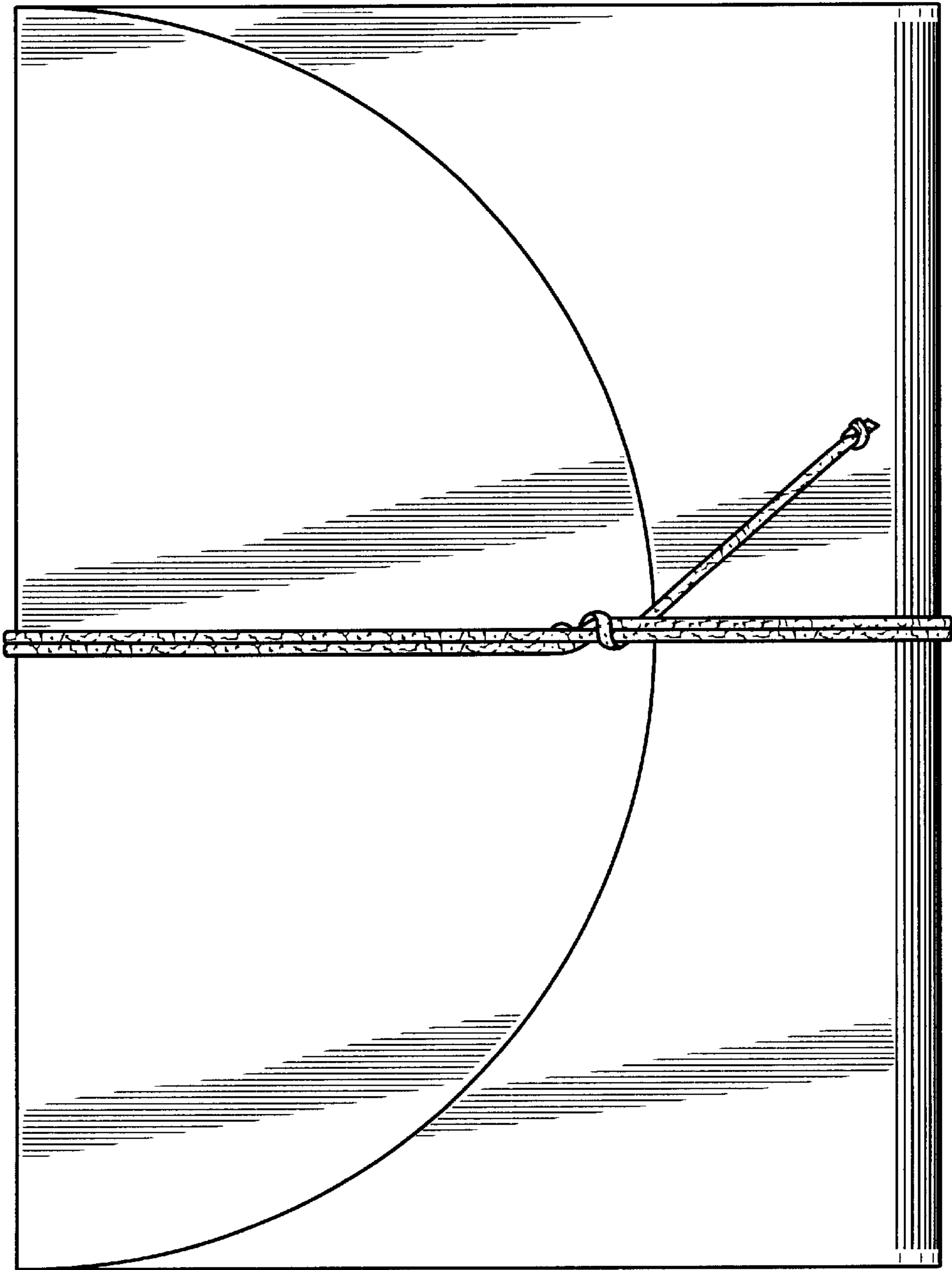

FIG.-2

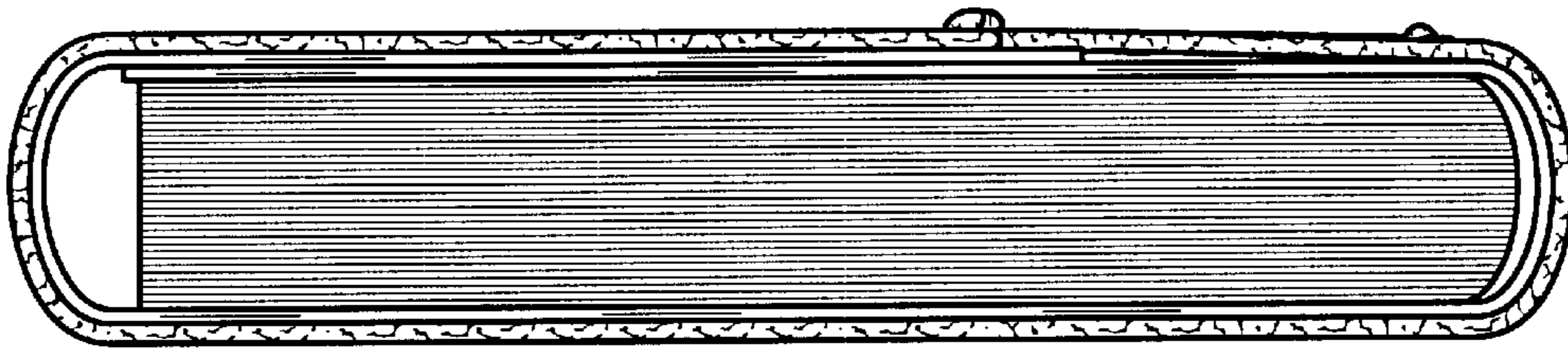

FIG. 5

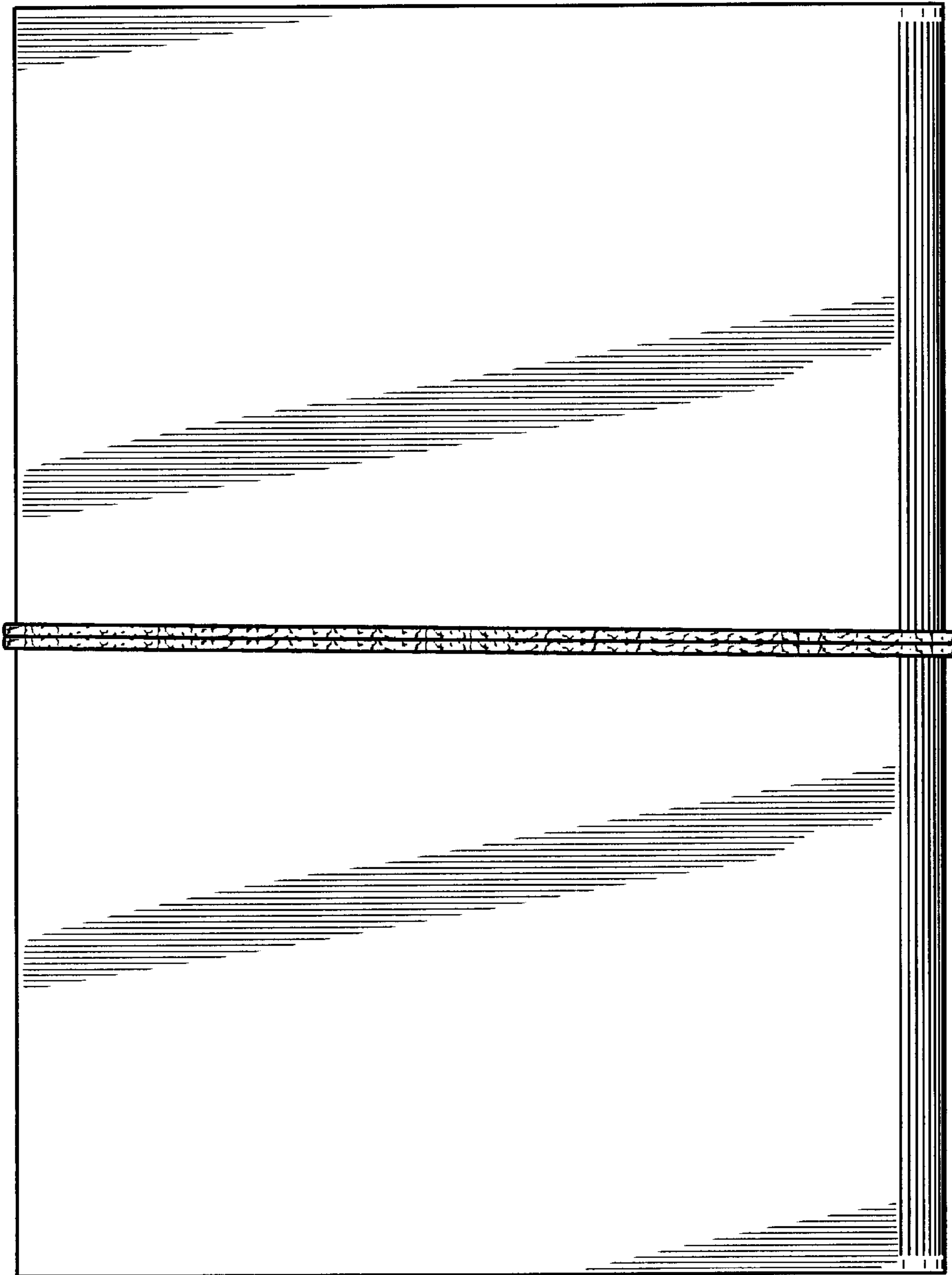

FIG. 4

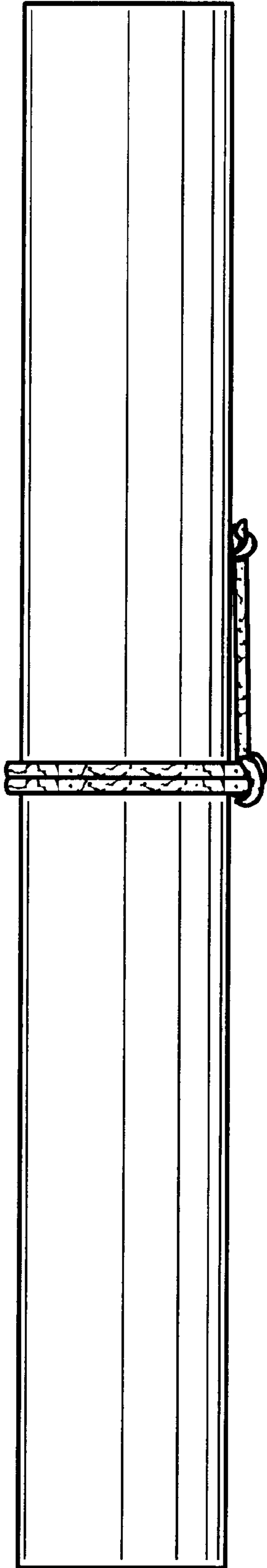

FIG. 6

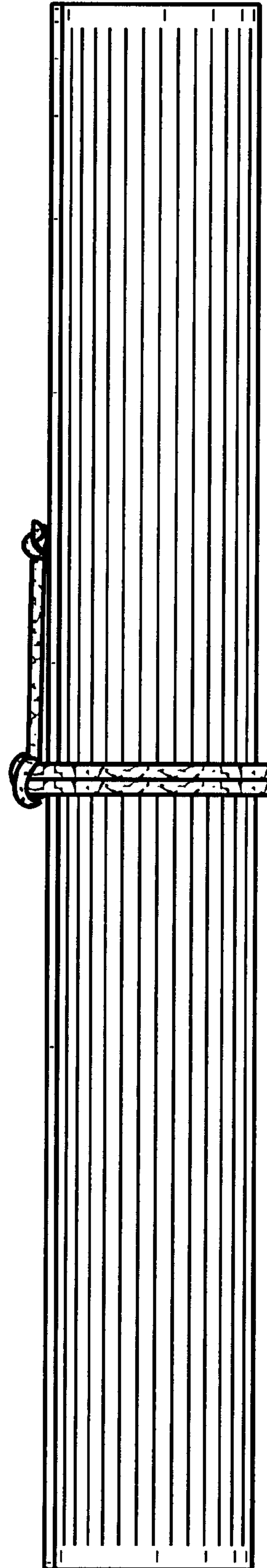

FIG. 7