



US00D475970S

(12) **United States Design Patent**
Li et al.

(10) **Patent No.:** **US D475,970 S**

(45) **Date of Patent:** **** Jun. 17, 2003**

(54) **OPTICAL SUB-ASSEMBLY MODULE**

D355,406 S * 2/1995 Smith D13/133
6,299,467 B1 * 10/2001 Chien 439/188

(75) Inventors: **Chang-You Li**, Chia-Yi (TW); **Ing-Jer Ho**, Hsin-Chu (TW); **Ling-Ying Chiang**, Hsin-Chu (TW); **Tuan-Yu Hung**, Hsin-Chu (TW); **Wen-Chih Hsieh**, Hsin-Chu Hsien (TW)

* cited by examiner

Primary Examiner—Holly Baynham
(74) *Attorney, Agent, or Firm*—Winston Hsu

(73) Assignee: **RiteKom Photonics Corporation**,
Hsin-Chu Hsien (TW)

(57) **CLAIM**

(**) Term: **14 Years**

The ornamental design for an optical sub-assembly module,
as shown and described.

(21) Appl. No.: **29/161,113**

DESCRIPTION

(22) Filed: **May 24, 2002**

(30) **Foreign Application Priority Data**

Feb. 8, 2002 (TW) 91300597

(51) **LOC (7) Cl.** **13-03**

(52) **U.S. Cl.** **D13/133**

(58) **Field of Search** D13/133, 123;
361/395; 362/363; 439/188, 668, 567, 490,
541.5, 79, 83, 871

FIG. 1 is a front elevational view of an optical sub-assembly
module showing our new design;

FIG. 2 is a rear elevational view thereof;

FIG. 3 is a left side elevational view thereof;

FIG. 4 is a right side elevational view thereof;

FIG. 5 is a top plan view thereof;

FIG. 6 is a bottom plan view thereof; and,

FIG. 7 is a perspective view thereof.

(56) **References Cited**

U.S. PATENT DOCUMENTS

D330,006 S * 10/1992 Kamakura et al. D13/123

1 Claim, 4 Drawing Sheets

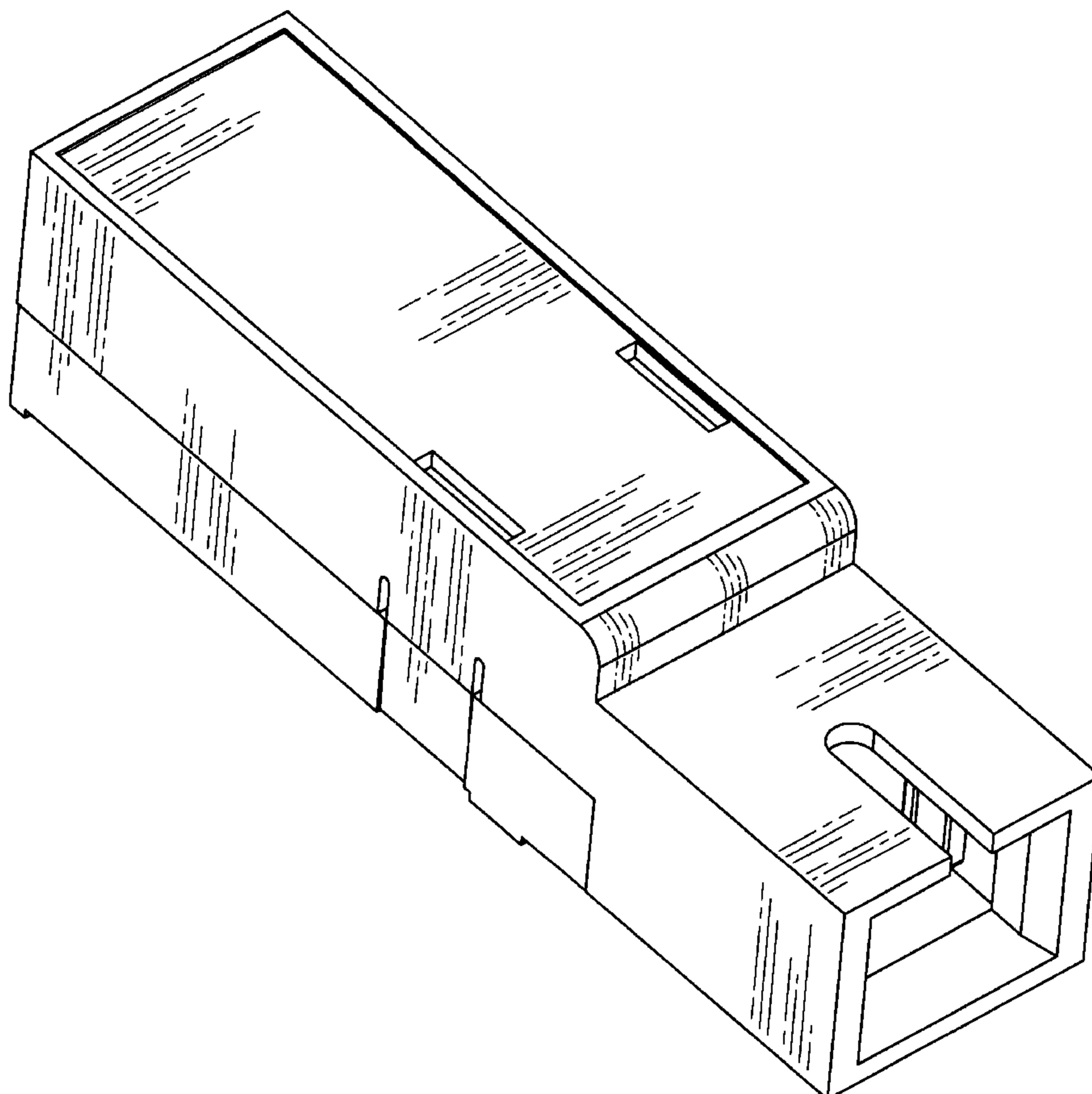

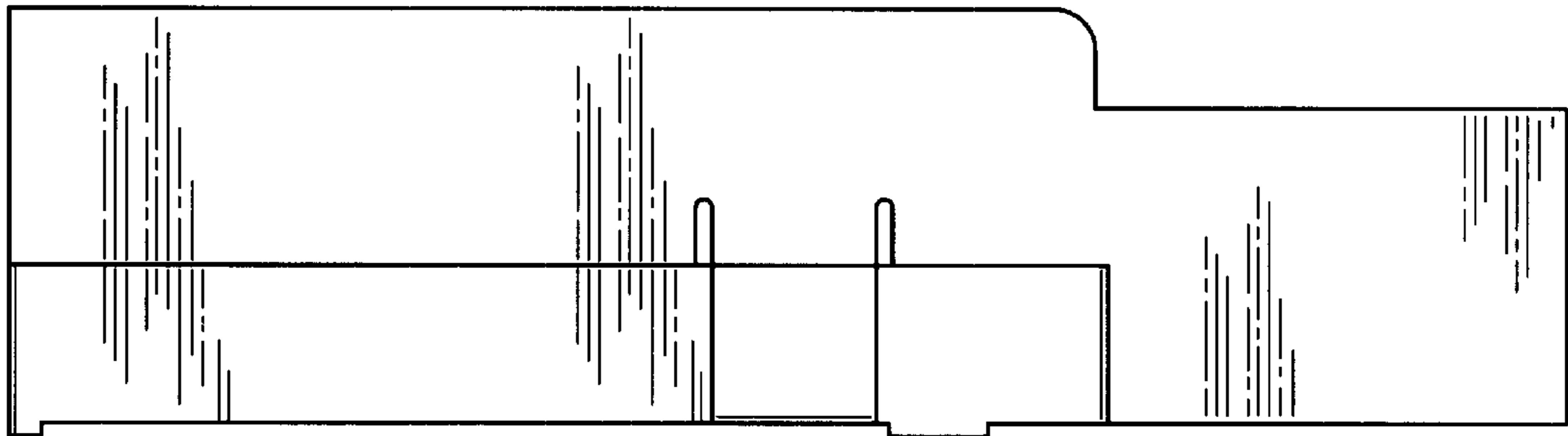

Fig. 1

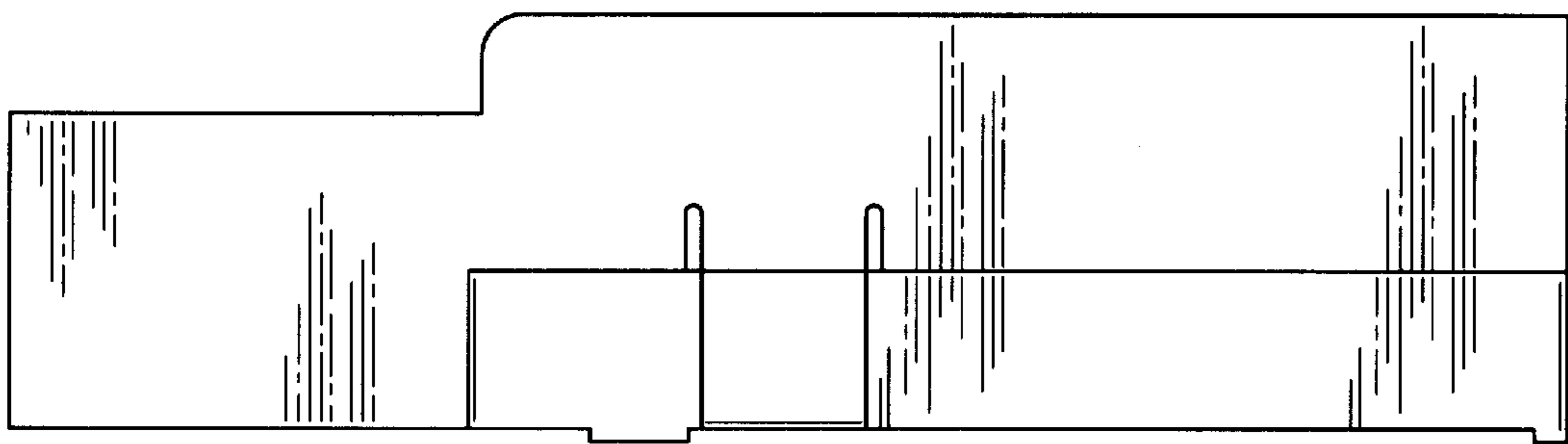

Fig. 2

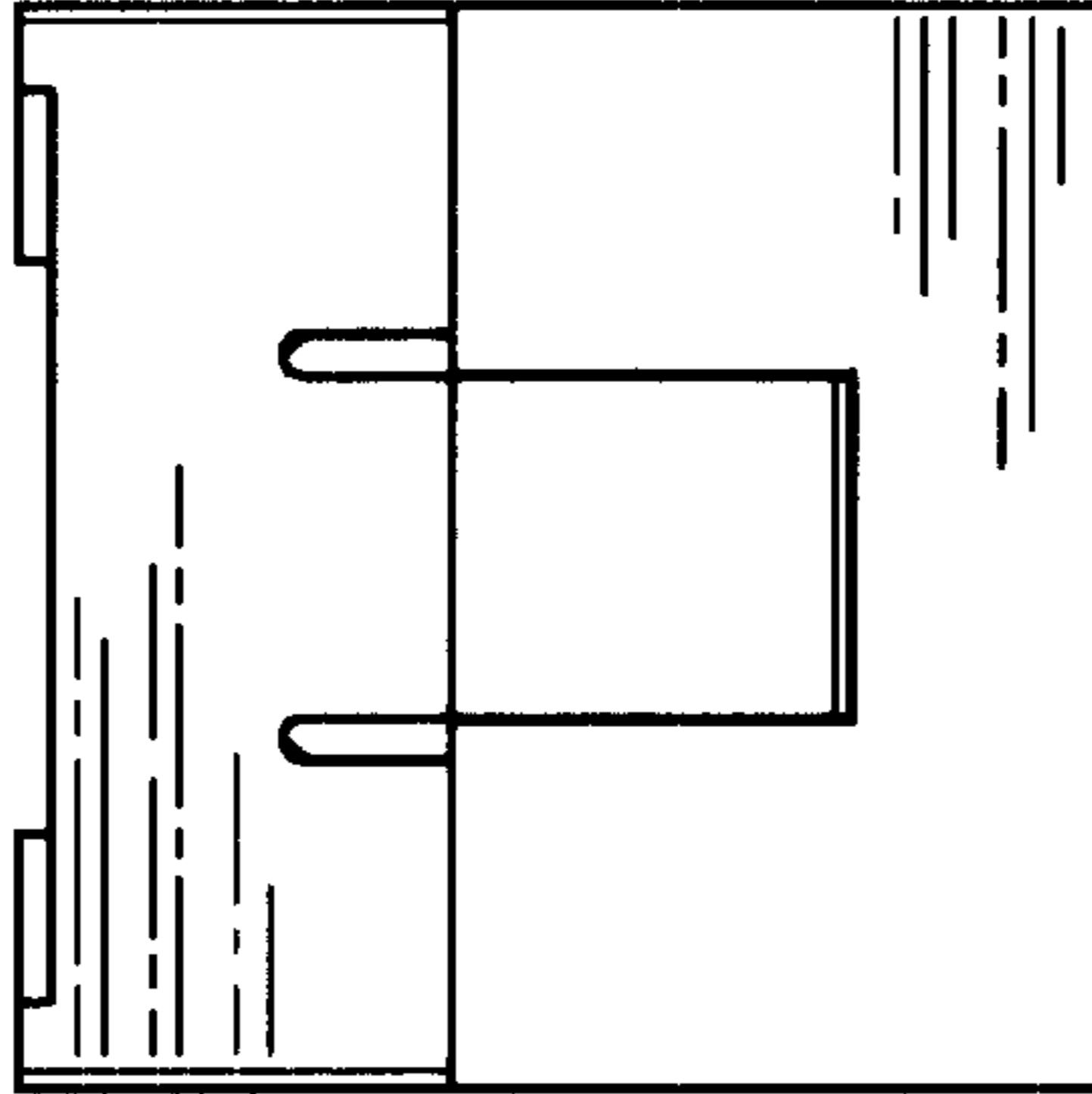

Fig. 3

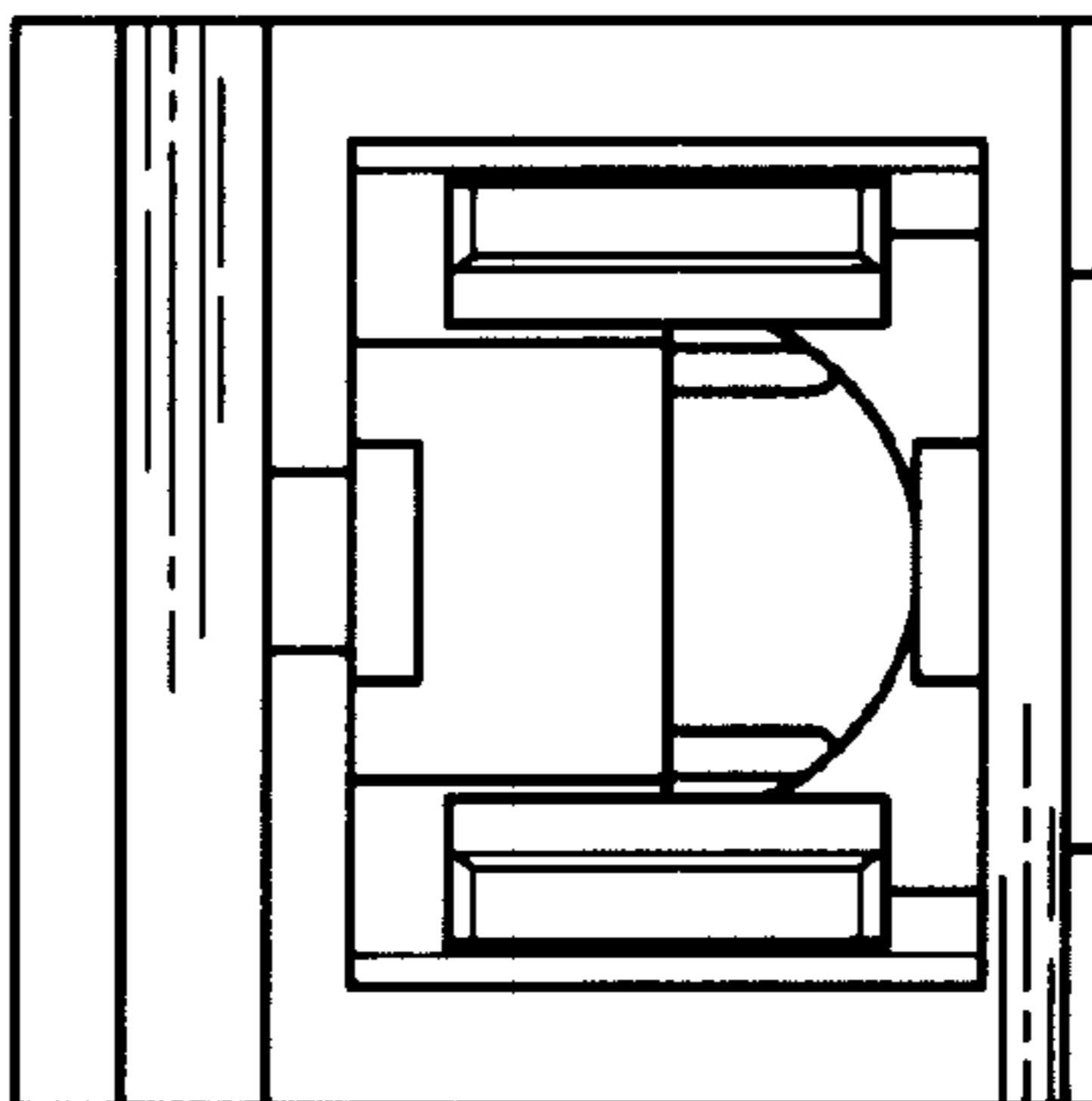

Fig. 4

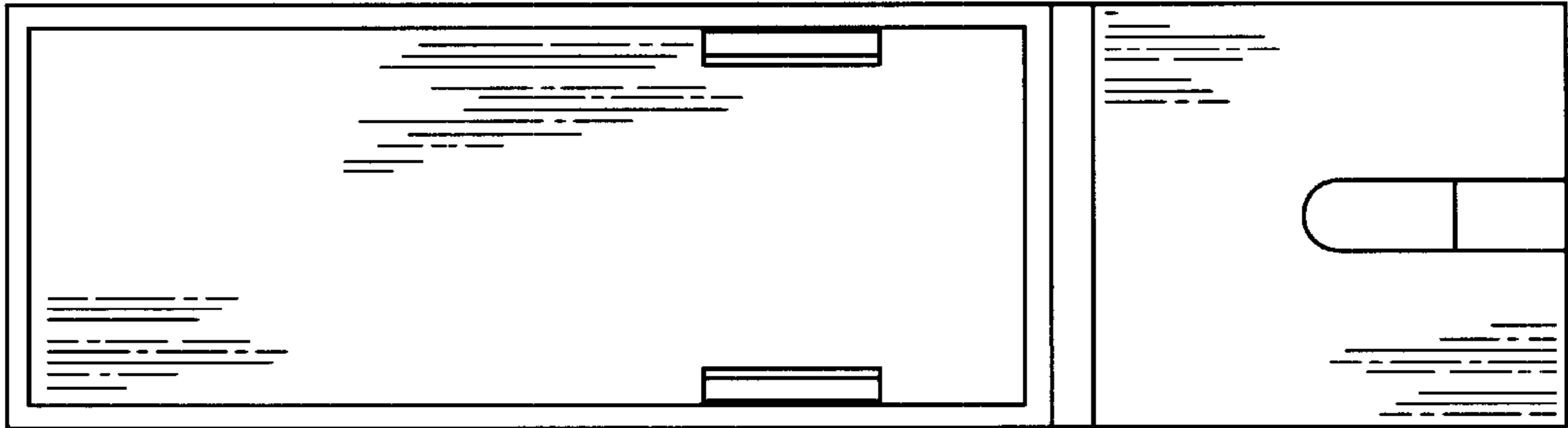

Fig. 5

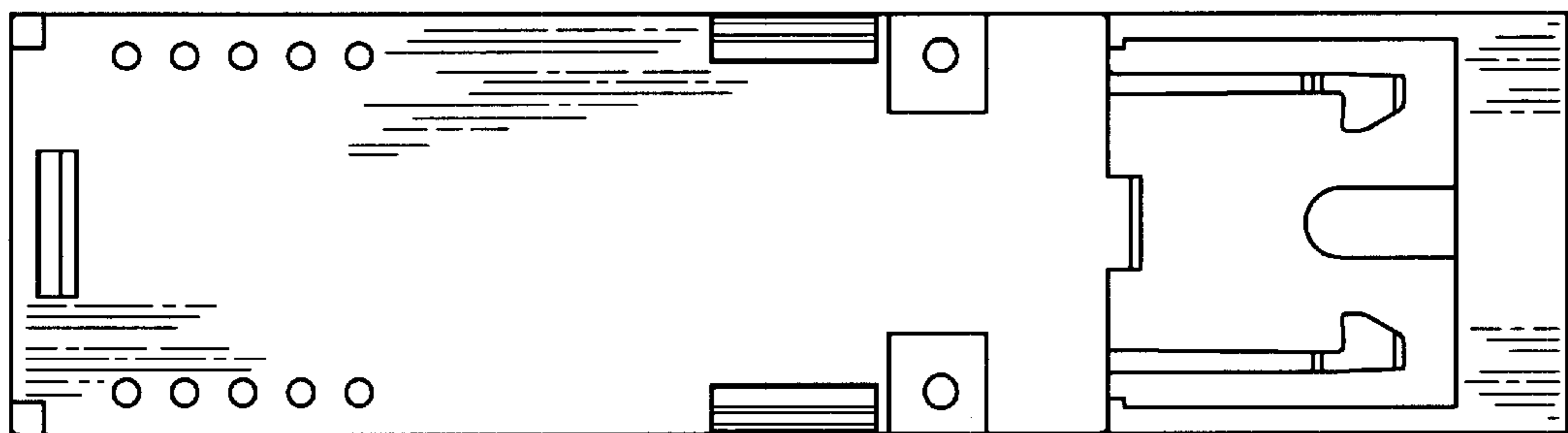

Fig. 6

