



US00D475967S

(12) **United States Design Patent**
Tsergas

(10) **Patent No.:** **US D475,967 S**

(45) **Date of Patent:** **** Jun. 17, 2003**

(54) **NARROW GEAR BOX**

(75) Inventor: **Athanase N. Tsergas**, Wood Dale, IL (US)

(73) Assignee: **Molon Motor & Coil Corporation**, Rolling Meadows, IL (US)

(**) Term: **14 Years**

(21) Appl. No.: **29/168,148**

(22) Filed: **Sep. 27, 2002**

Related U.S. Application Data

(62) Division of application No. 29/155,737, filed on Feb. 19, 2002, which is a division of application No. 29/124,917, filed on Jun. 14, 2000, now Pat. No. Des. 461,164.

(51) **LOC (7) Cl.** **13-02**

(52) **U.S. Cl.** **D13/122**

(58) **Field of Search** D13/118, 122;
310/83, 89, 99; 74/421 A, 606 R

(56) **References Cited**

U.S. PATENT DOCUMENTS

4,147,071 A *	4/1979	Scribner et al.	74/421 A X
4,706,512 A *	11/1987	McKernon et al. ...	74/421 A X
5,072,164 A	12/1991	Pruis et al.	
D327,051 S	6/1992	Schwartz	
5,172,605 A	12/1992	Schwartz	
5,256,921 A	10/1993	Pruis et al.	
5,446,326 A	8/1995	Scheider	
5,737,968 A	4/1998	Hardey et al.	
5,747,897 A *	5/1998	Iwasa et al.	310/49 R
5,947,328 A	9/1999	Koven et al.	
6,028,384 A *	2/2000	Billman et al.	310/83
6,054,785 A *	4/2000	Kerdjoudj et al.	310/83 X
6,122,994 A *	9/2000	Norfolk et al.	74/606 R
6,272,941 B1 *	8/2001	Phillips	74/412 R X

* cited by examiner

Primary Examiner—Joel Sincavage

(74) *Attorney, Agent, or Firm*—Oblon, Spivak, McClelland, Maier & Neustadt, P.C.

(57) **CLAIM**

An ornamental design for a narrow gear box, as shown and described.

DESCRIPTION

FIG. 1 is a top plan view of a first embodiment of a narrow gear box showing my new design.

FIG. 2 is a bottom plan view thereof.

FIG. 3 is a front elevational view thereof.

FIG. 4 is a rear elevational view thereof.

FIG. 5 is a left side view thereof.

FIG. 6 is a right side view thereof.

FIG. 7 is a top plan view of a second embodiment.

FIG. 8 is a bottom plan view thereof.

FIG. 9 is a front elevational view thereof.

FIG. 10 is a rear elevational view thereof.

FIG. 11 is a left side view thereof.

FIG. 12 is a right side view thereof.

FIG. 13 is a top plan view of a third embodiment.

FIG. 14 is a bottom plan view thereof.

FIG. 15 is a front elevational view thereof.

FIG. 16 is a rear elevational view thereof.

FIG. 17 is a left side view thereof.

FIG. 18 is a right side view thereof.

FIG. 19 is a top plan view of a fourth embodiment.

FIG. 20 is a bottom plan view thereof.

FIG. 21 is a front elevational view thereof.

FIG. 22 is a rear elevational view thereof.

FIG. 23 is a left side view thereof; and,

FIG. 24 is a right side view thereof.

1 Claim, 12 Drawing Sheets

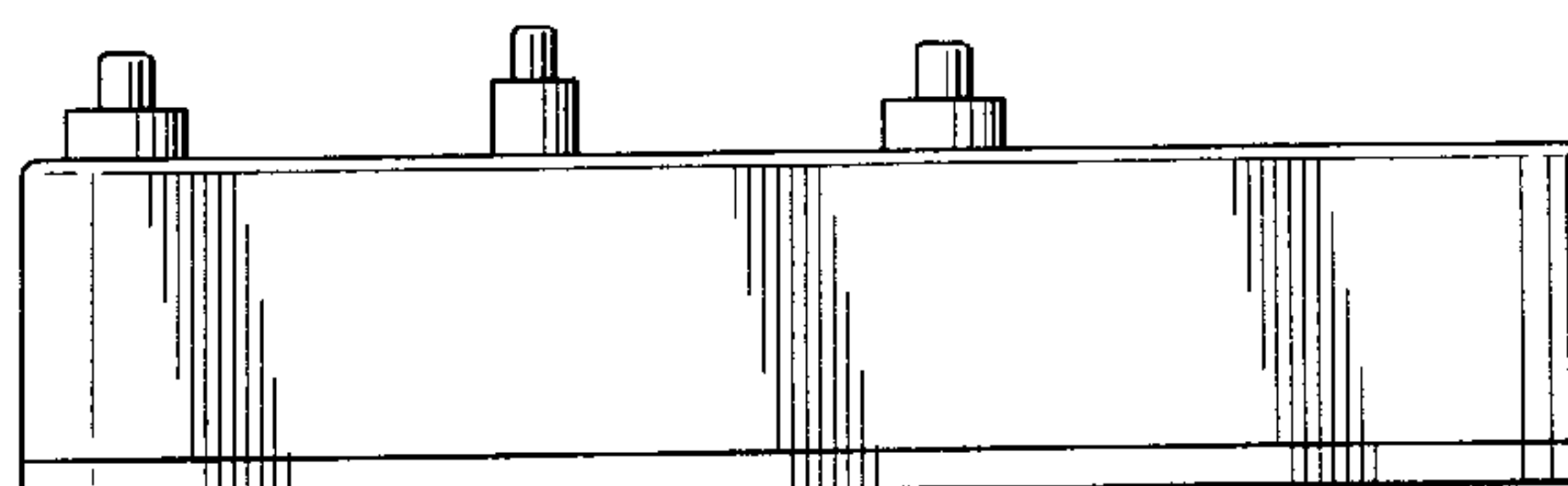
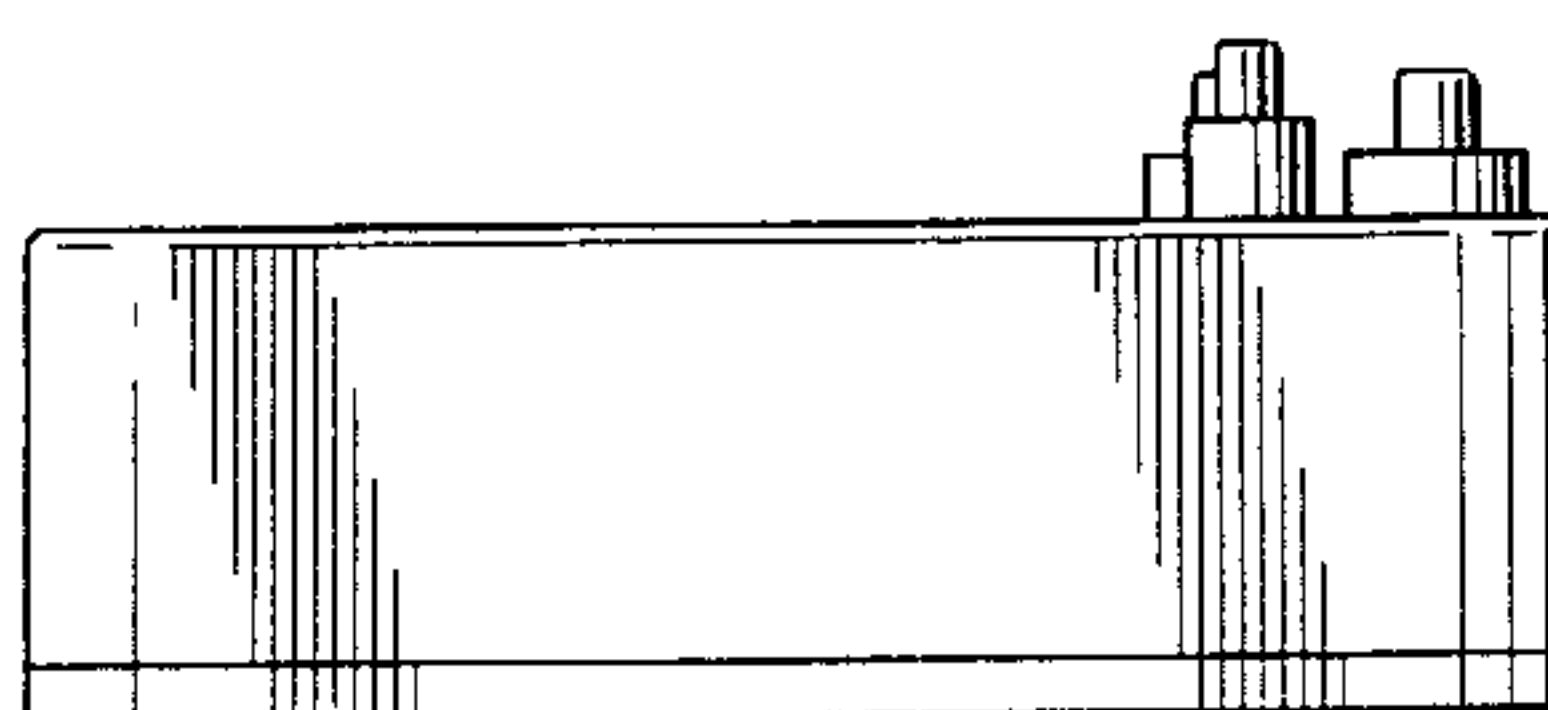
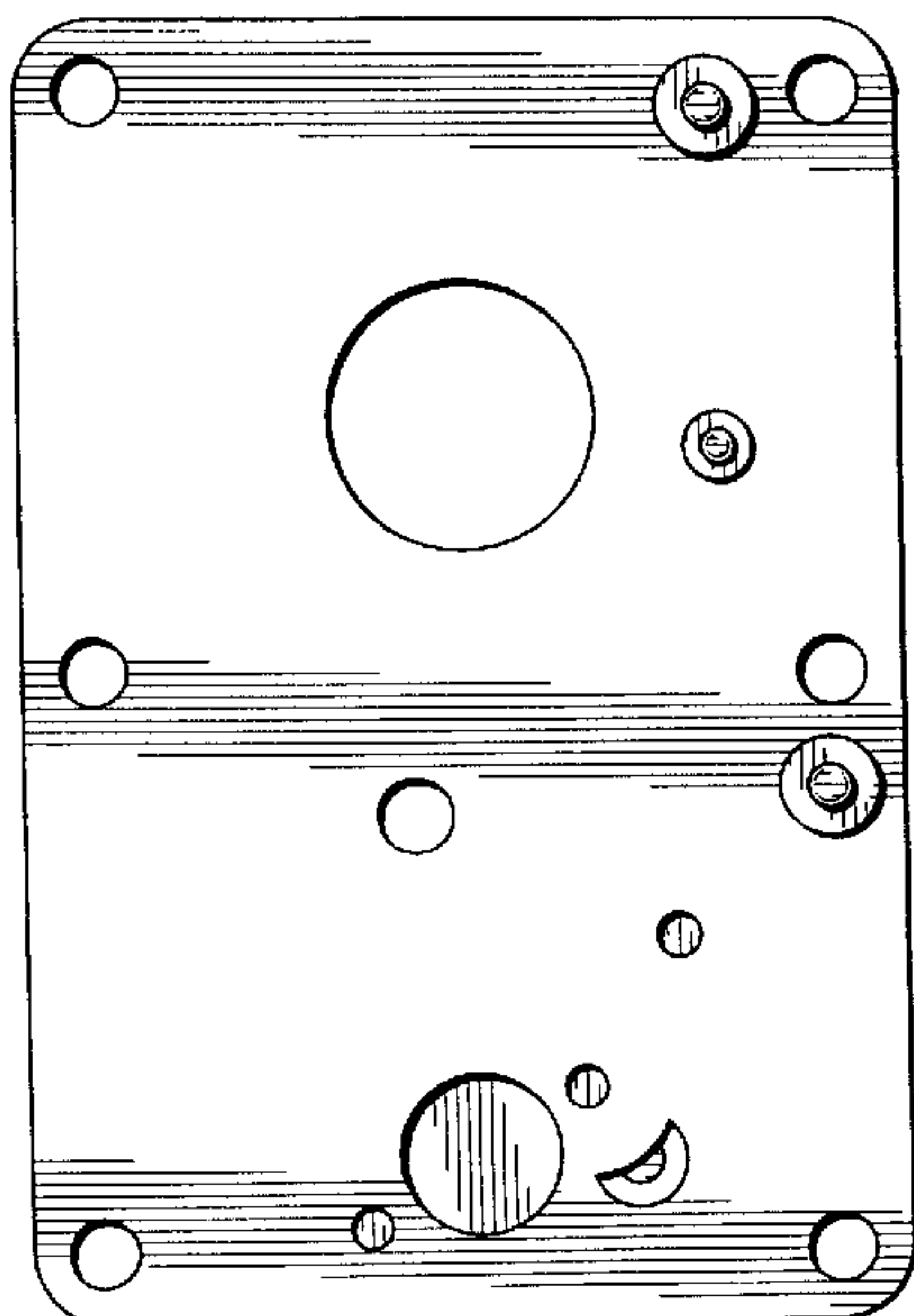

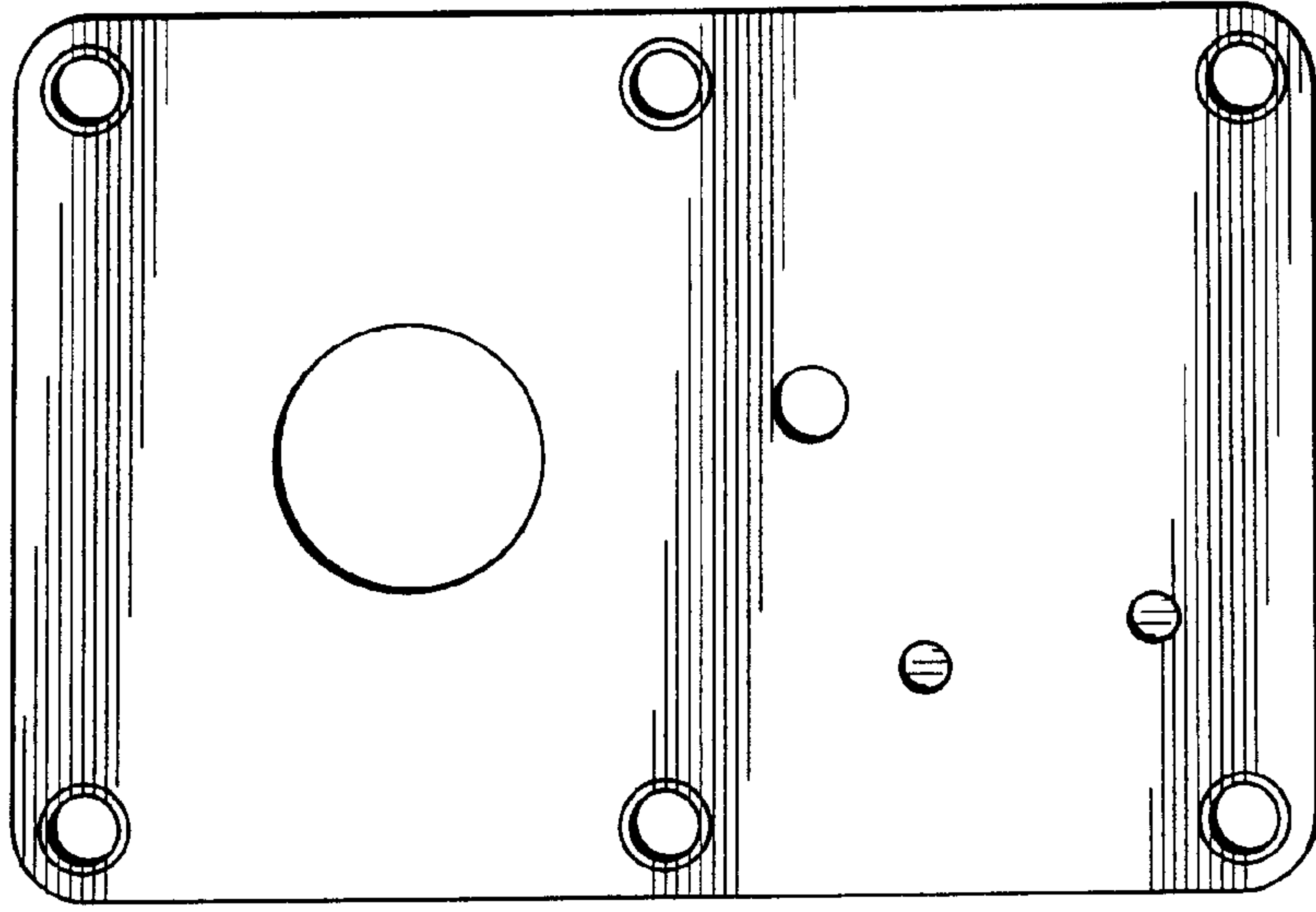

FIG. 2

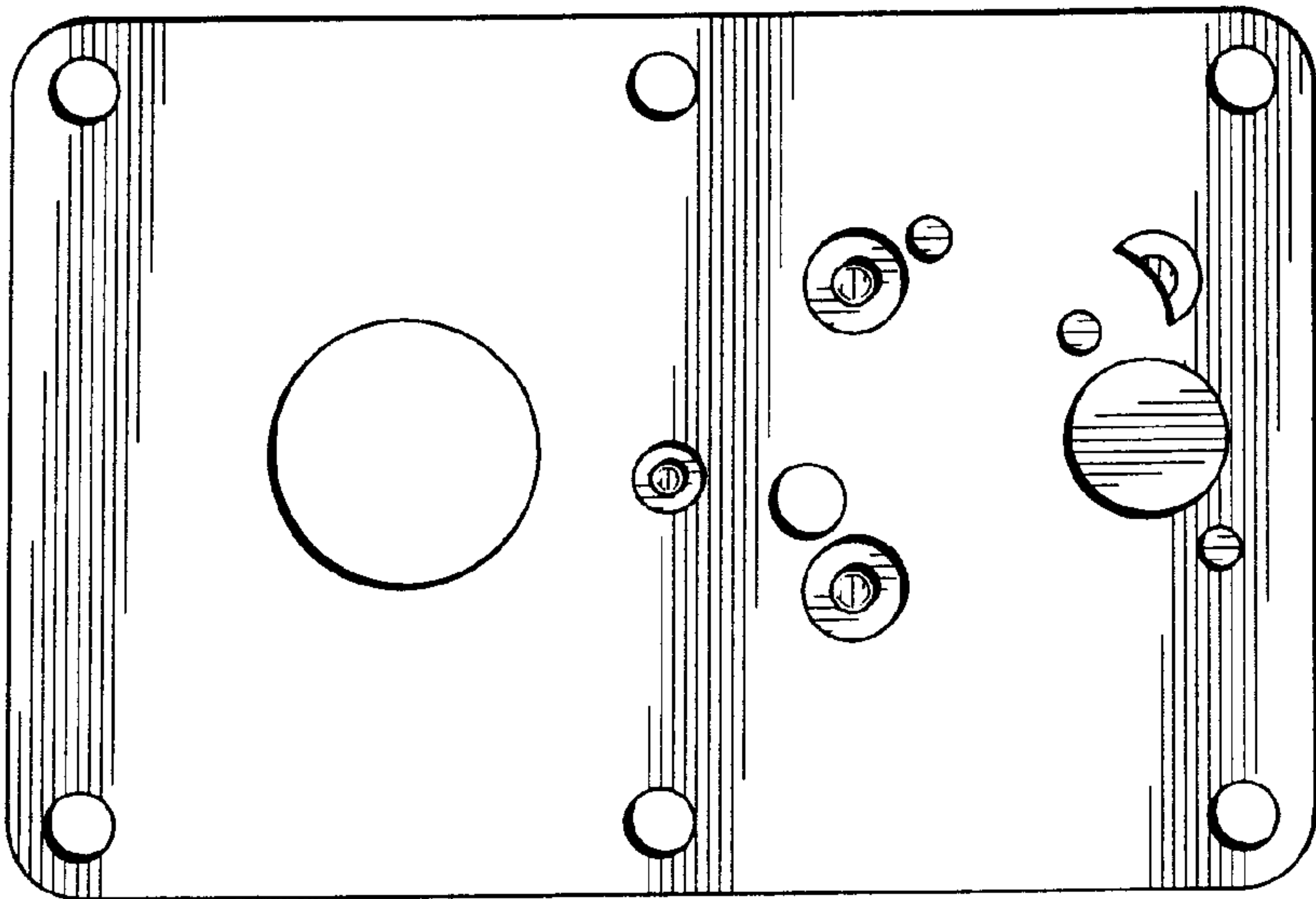

FIG. 1

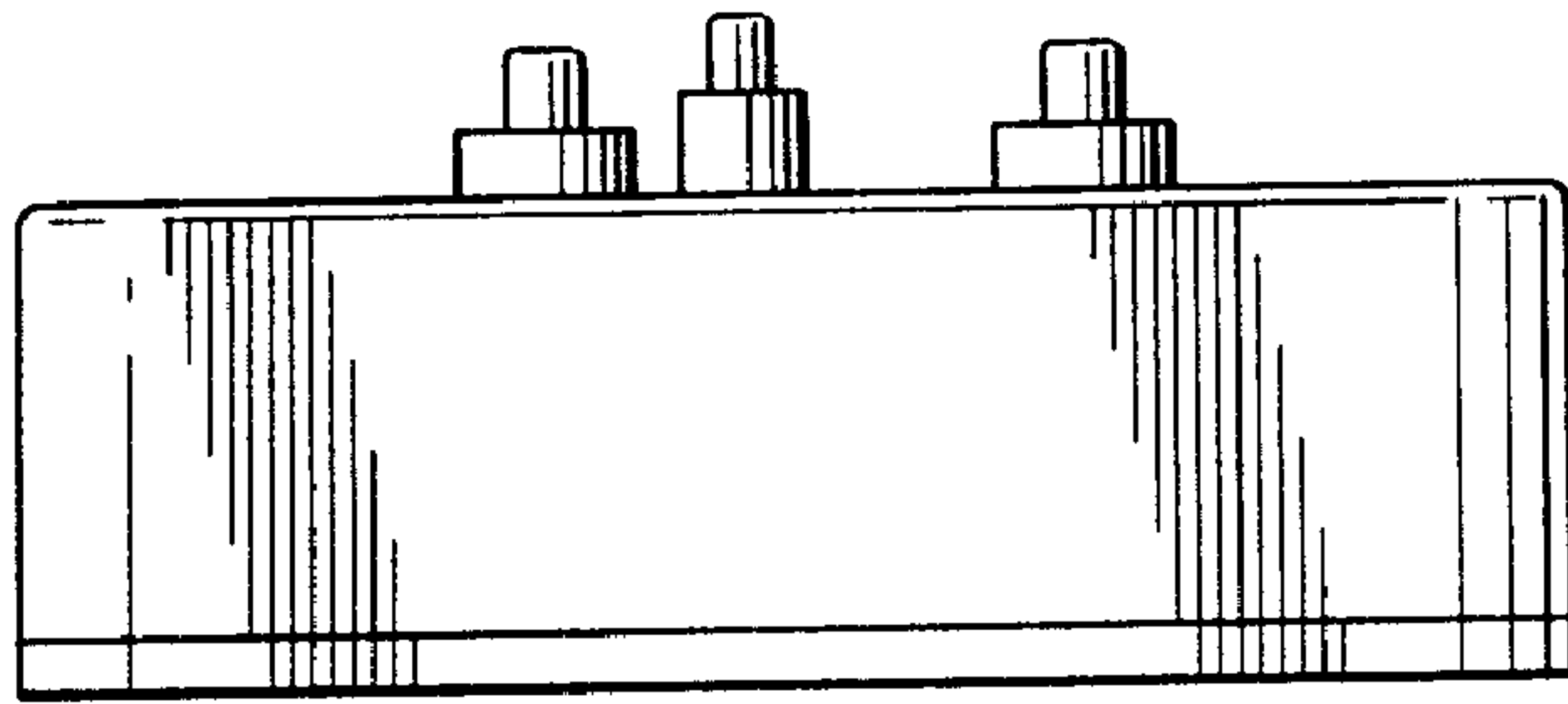

FIG. 3

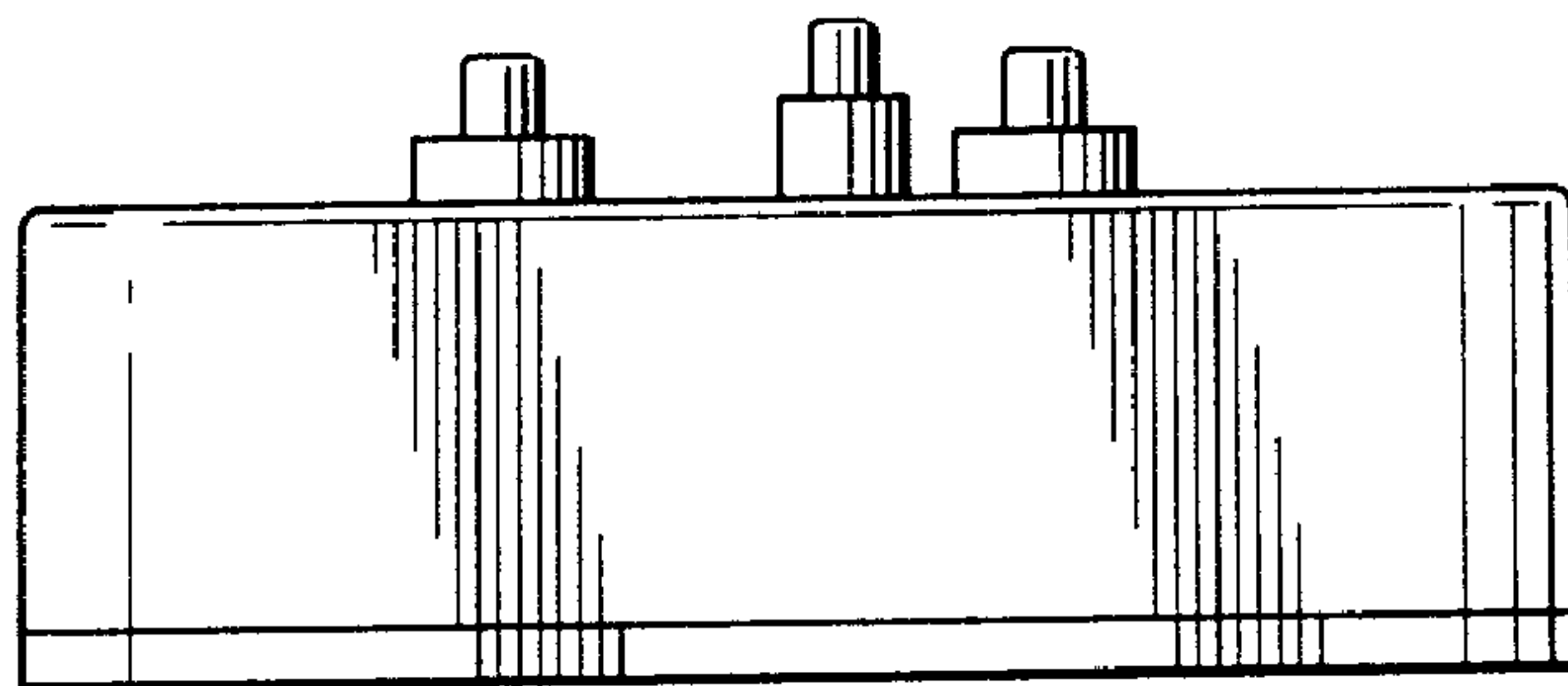

FIG. 4

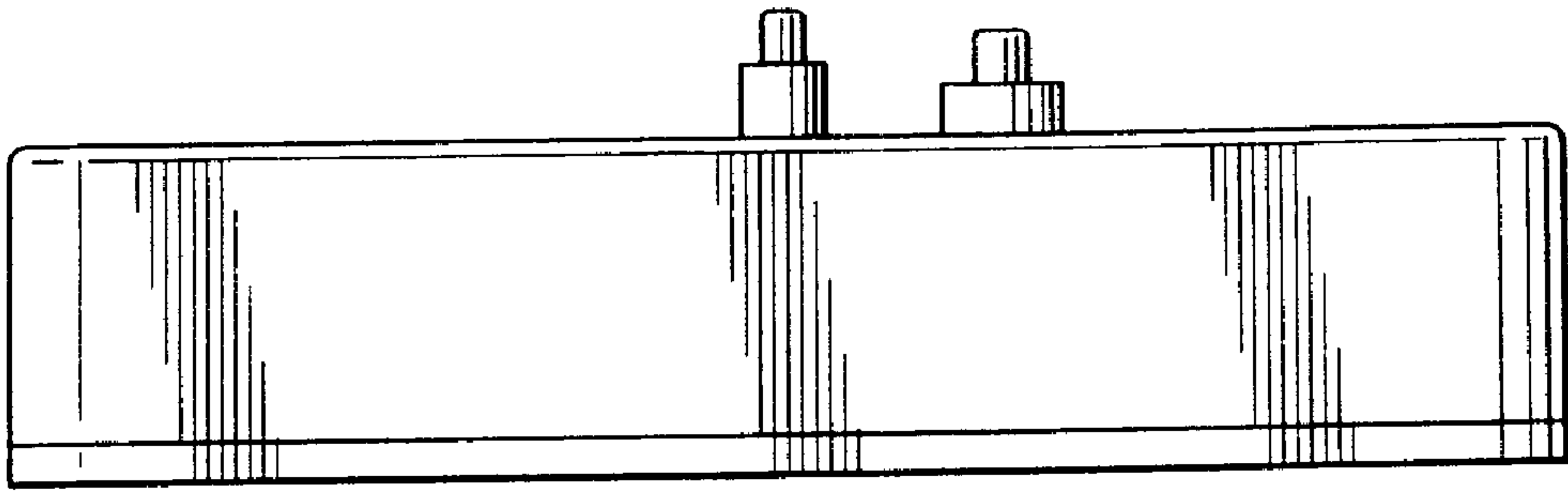

FIG. 5

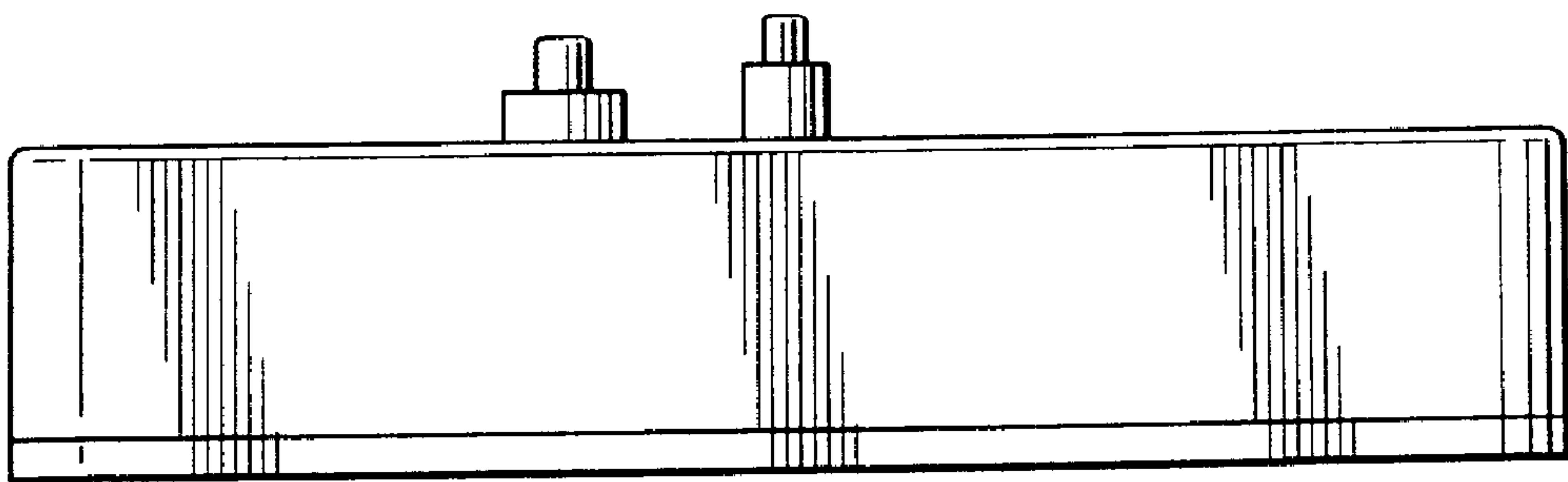

FIG. 6

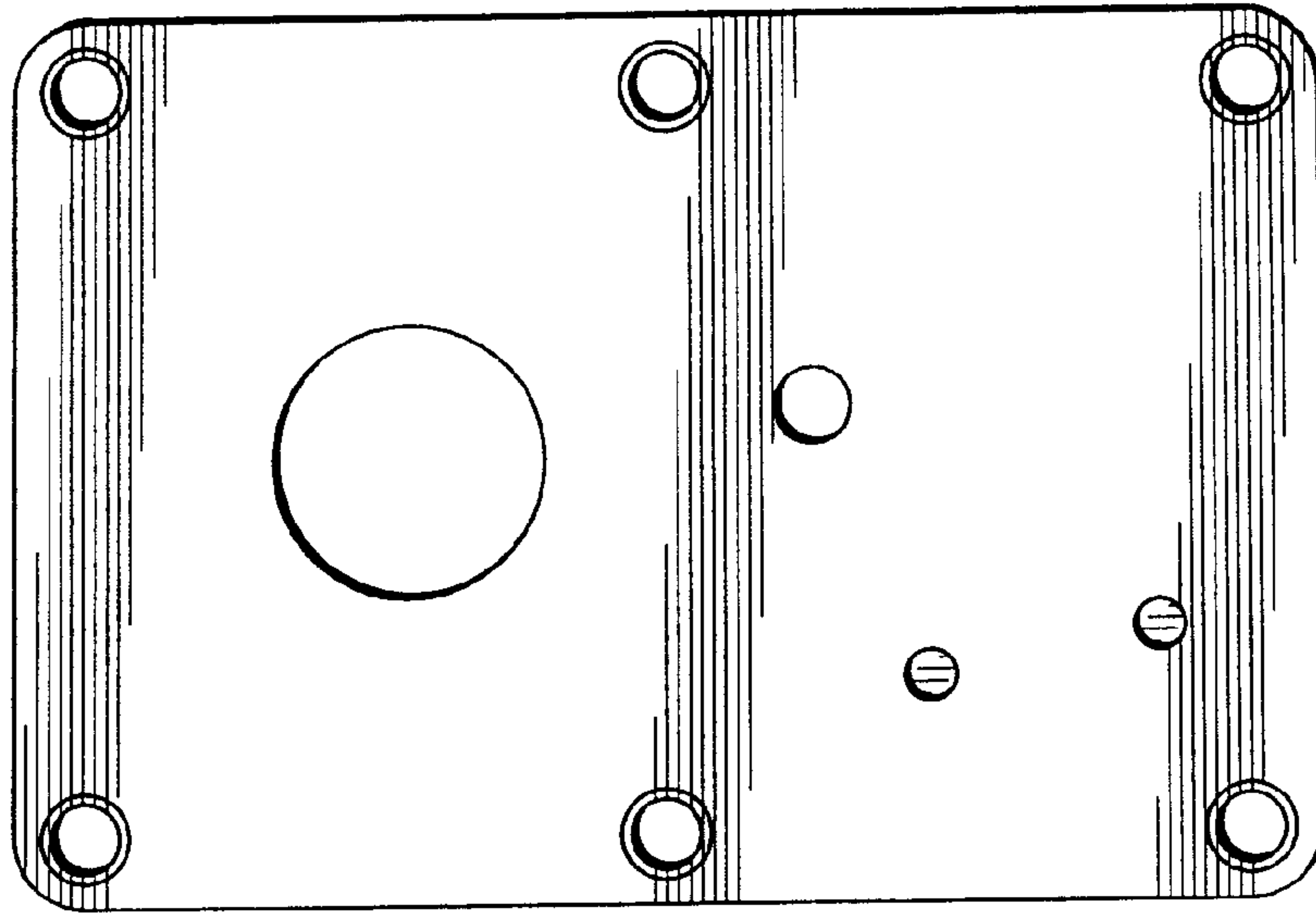

FIG. 8

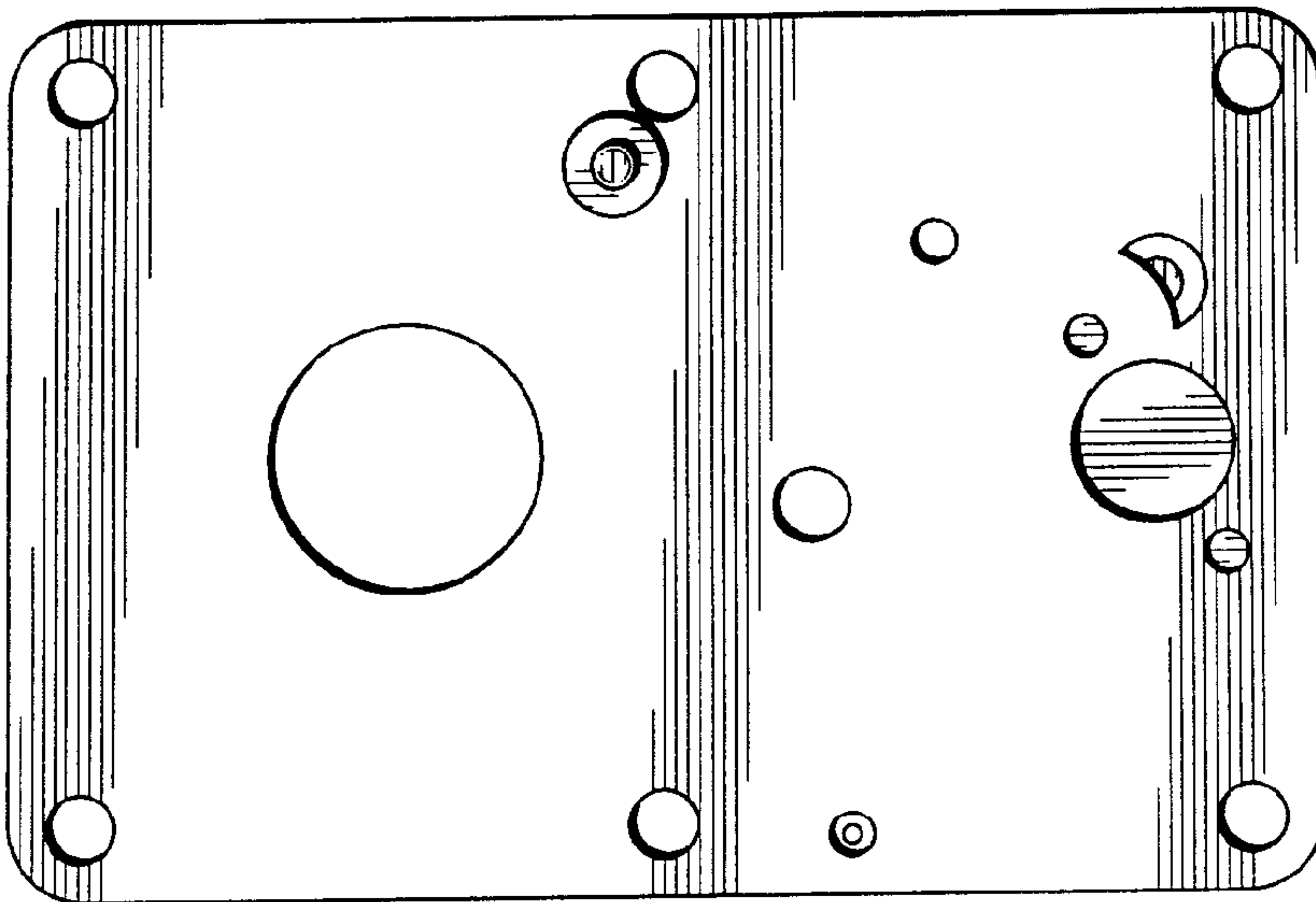

FIG. 7

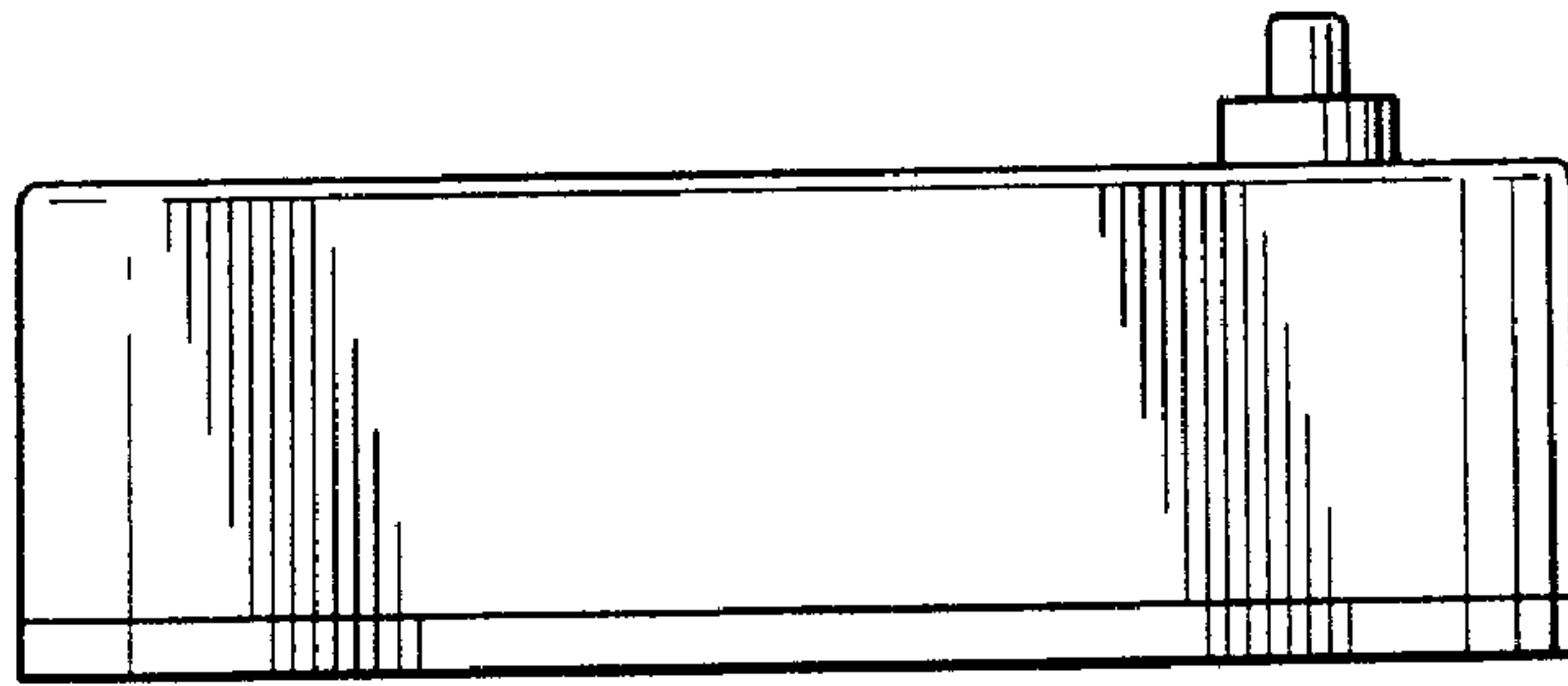

FIG. 9

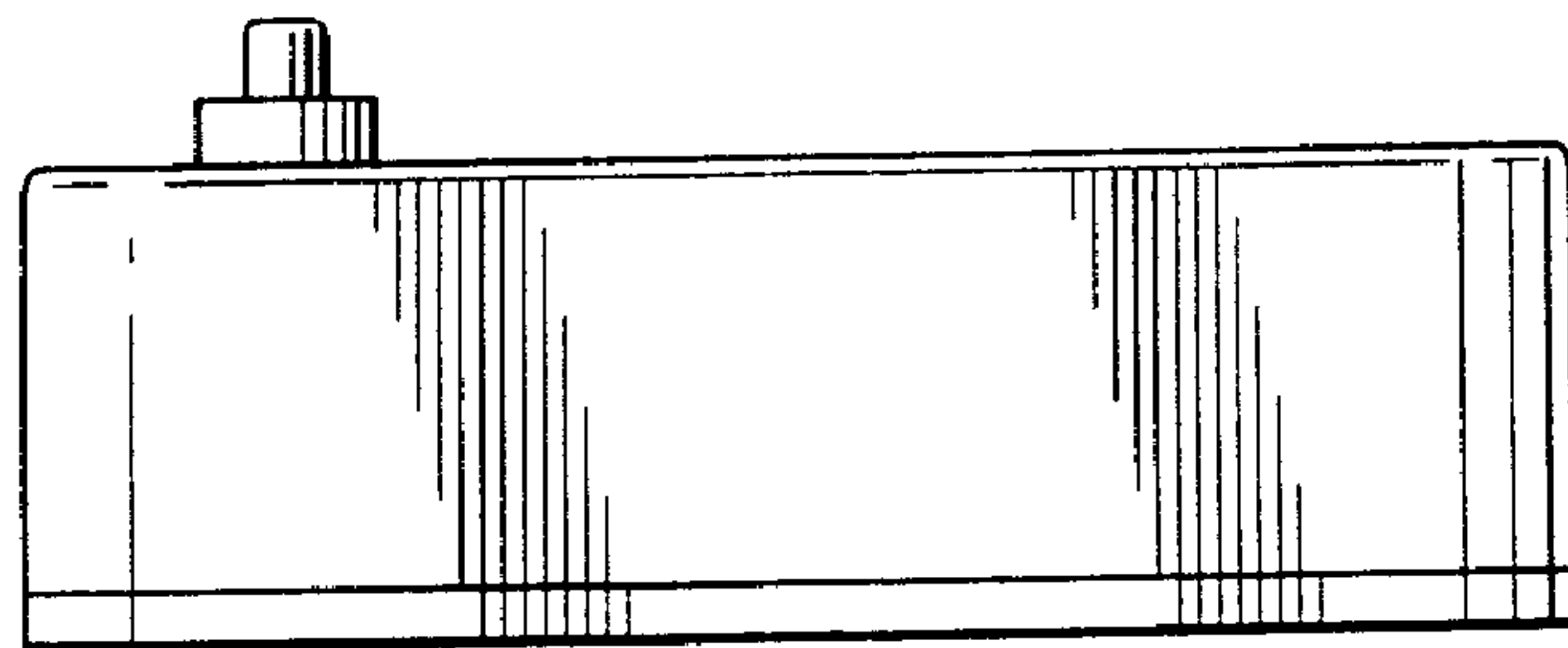

FIG. 10

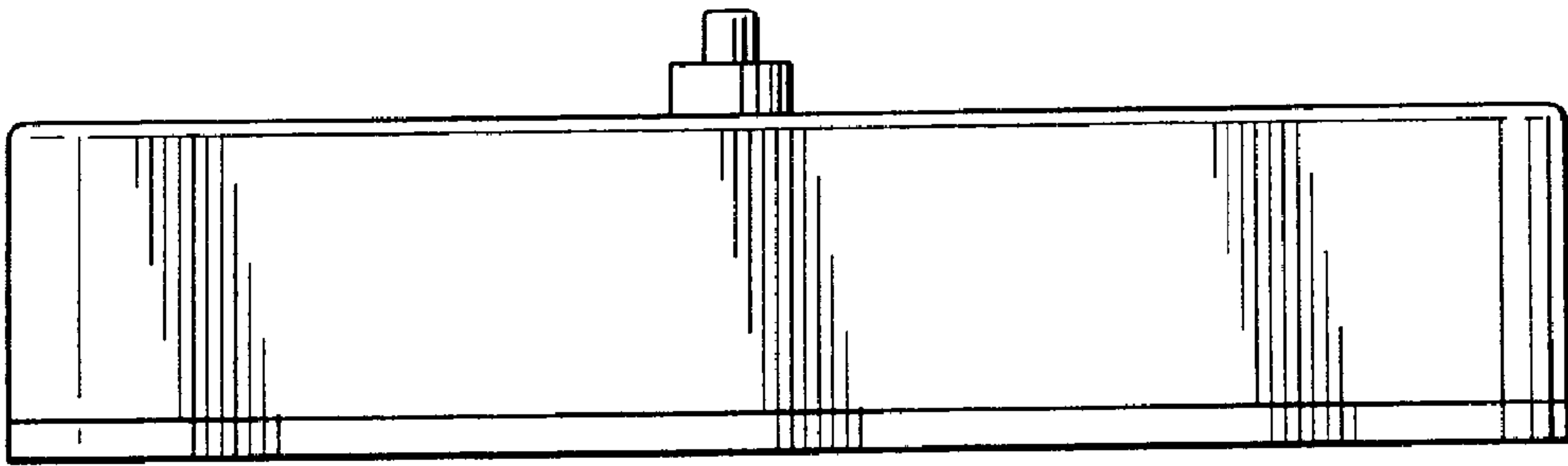

FIG. 11

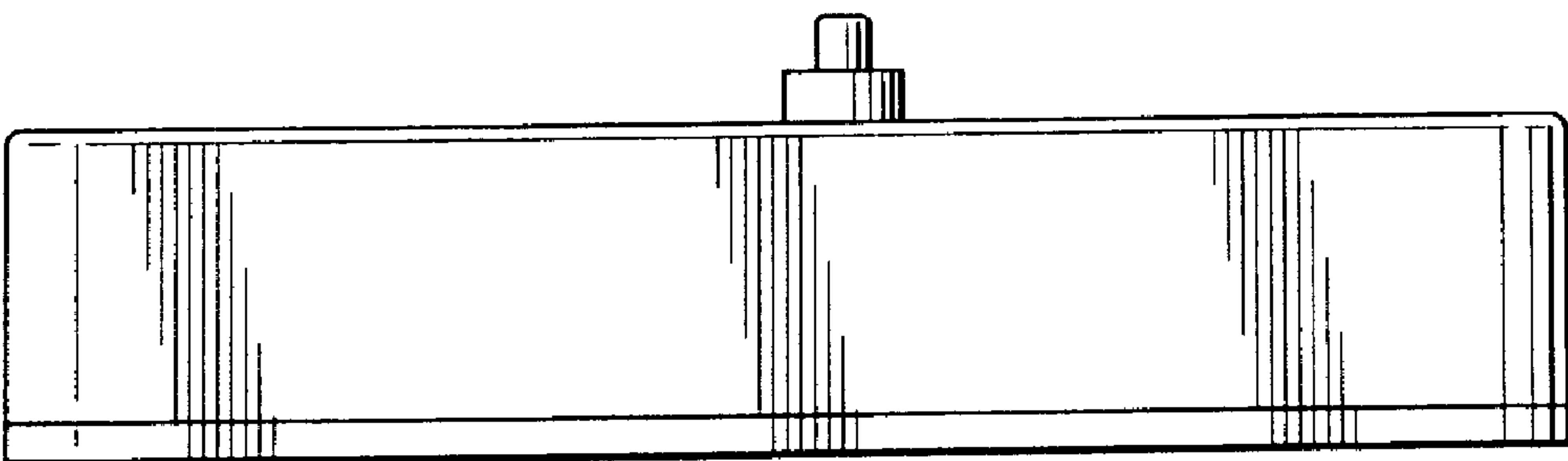

FIG. 12

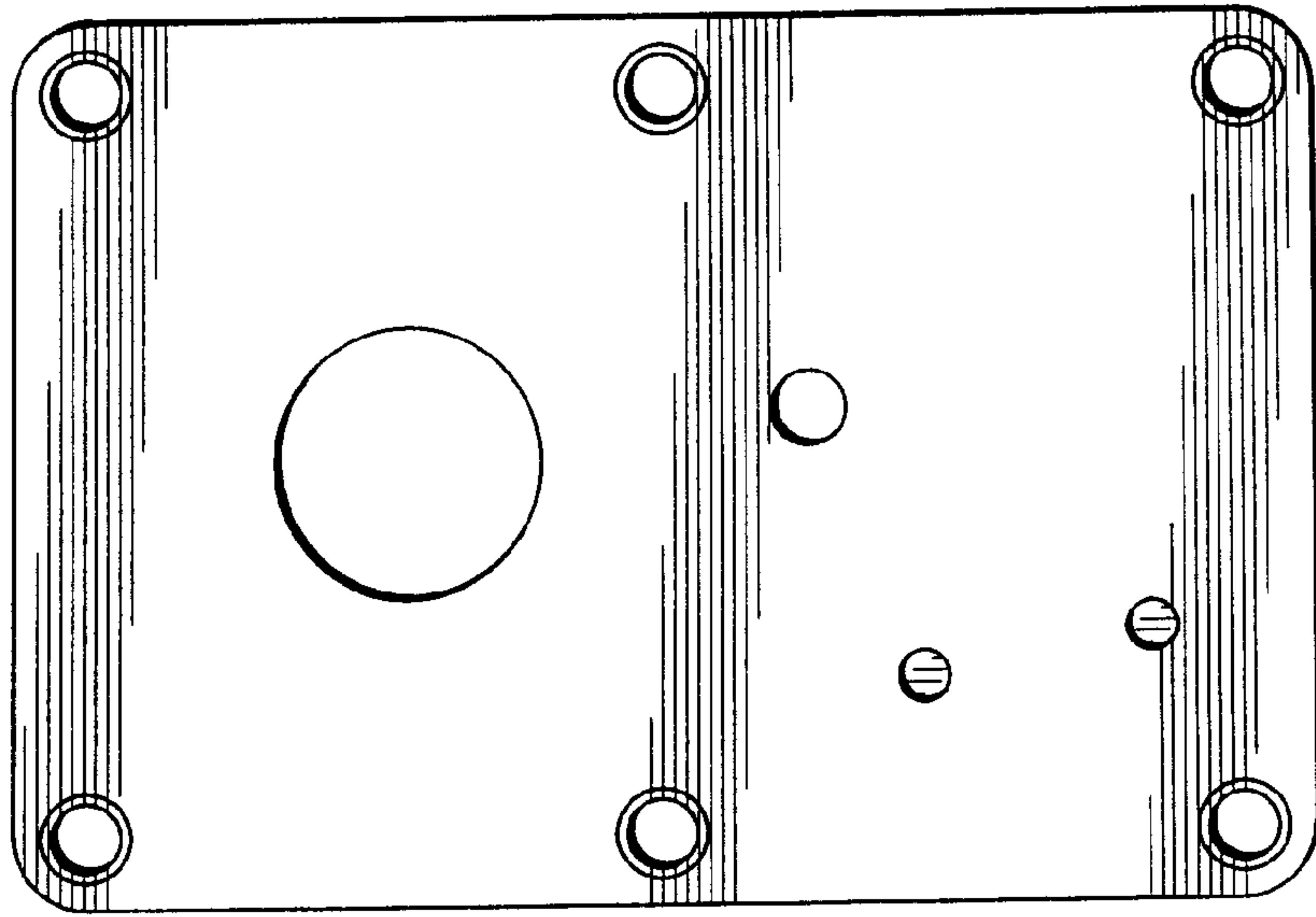

FIG. 14

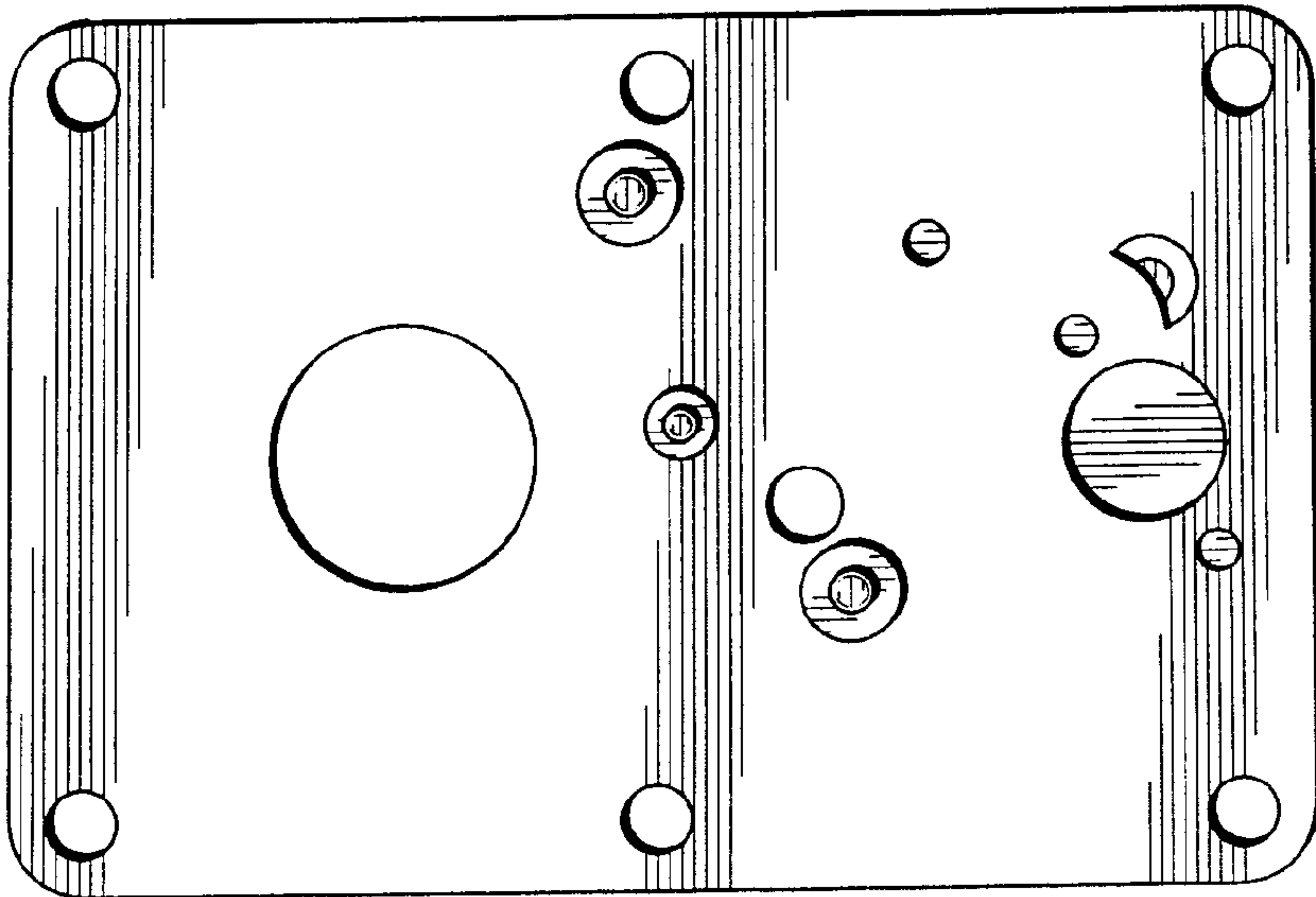

FIG. 13

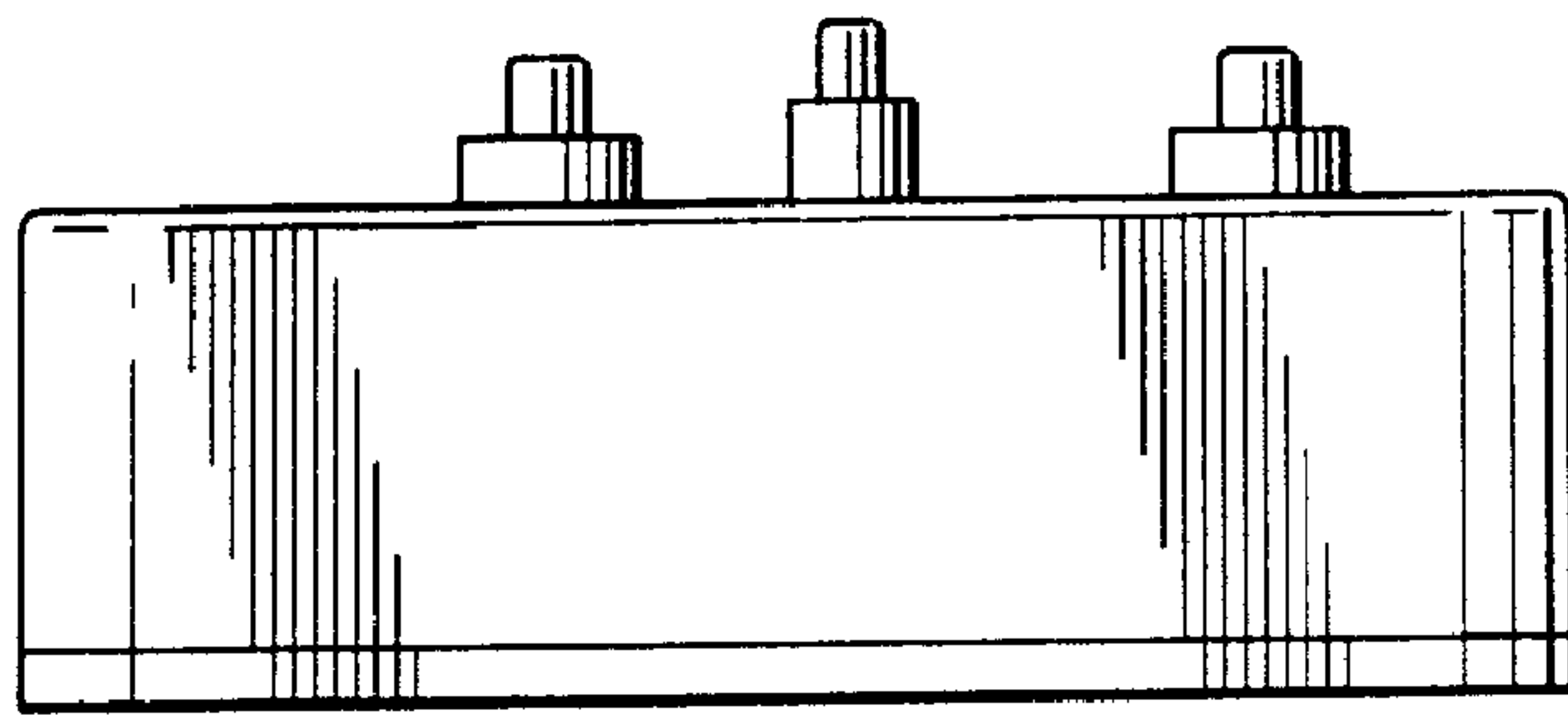

FIG. 15

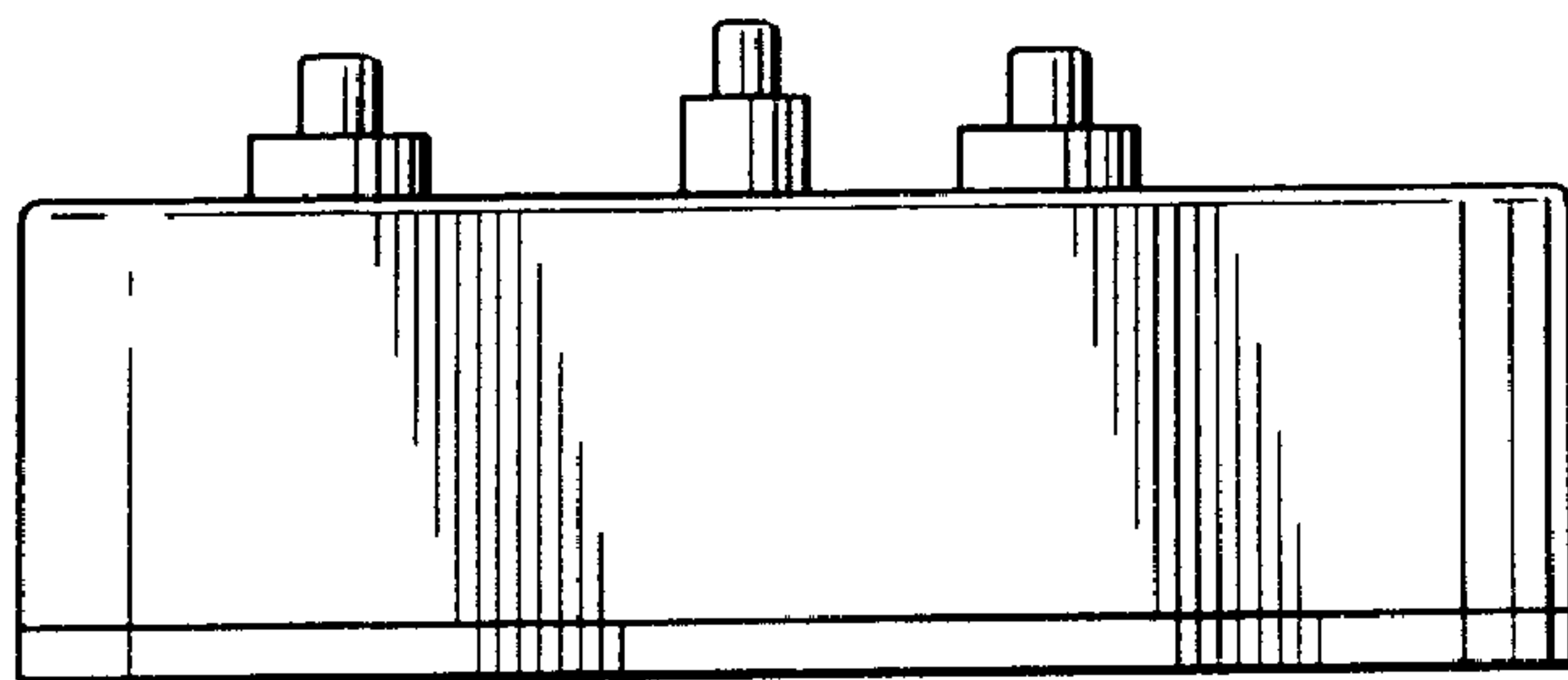

FIG. 16

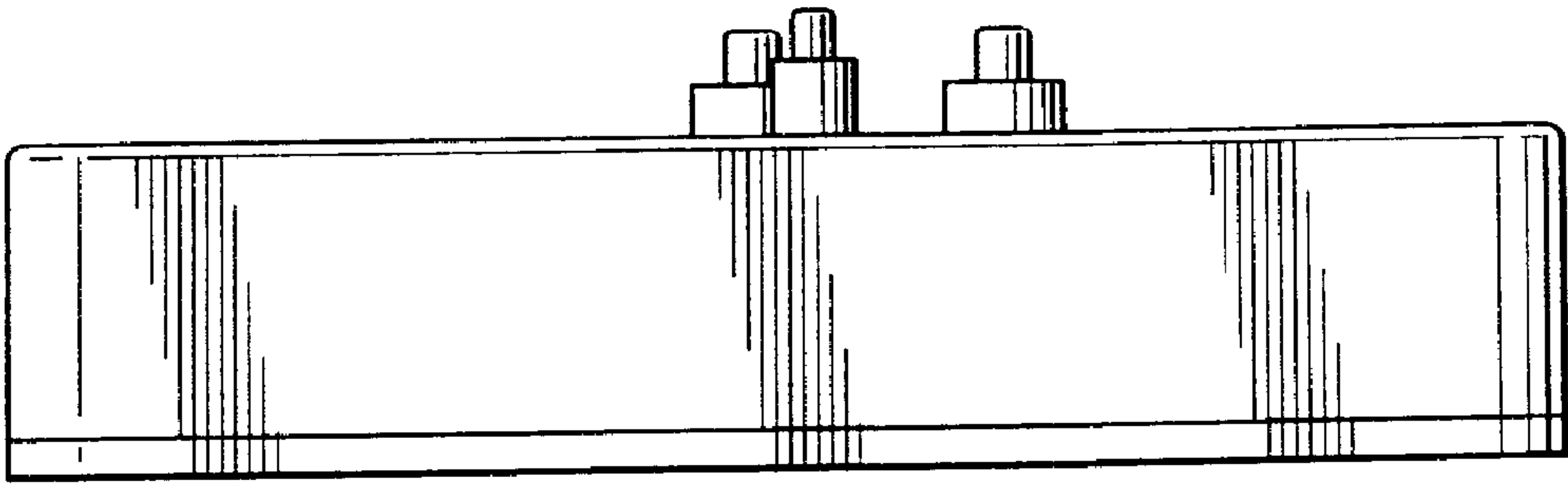

FIG. 17

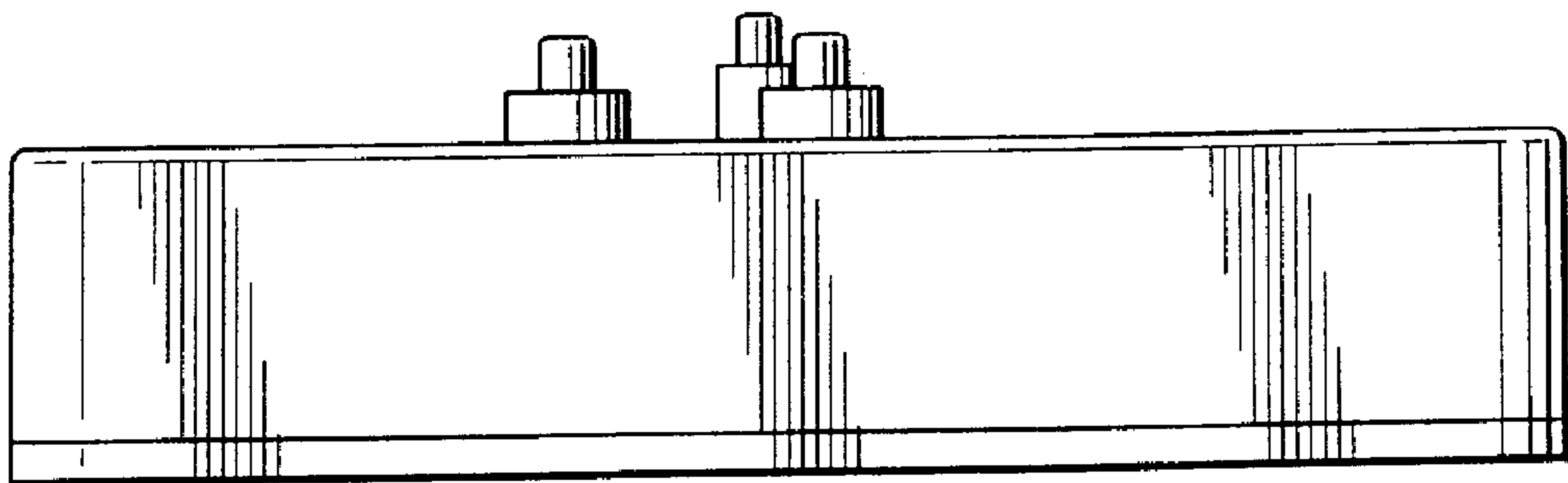

FIG. 18

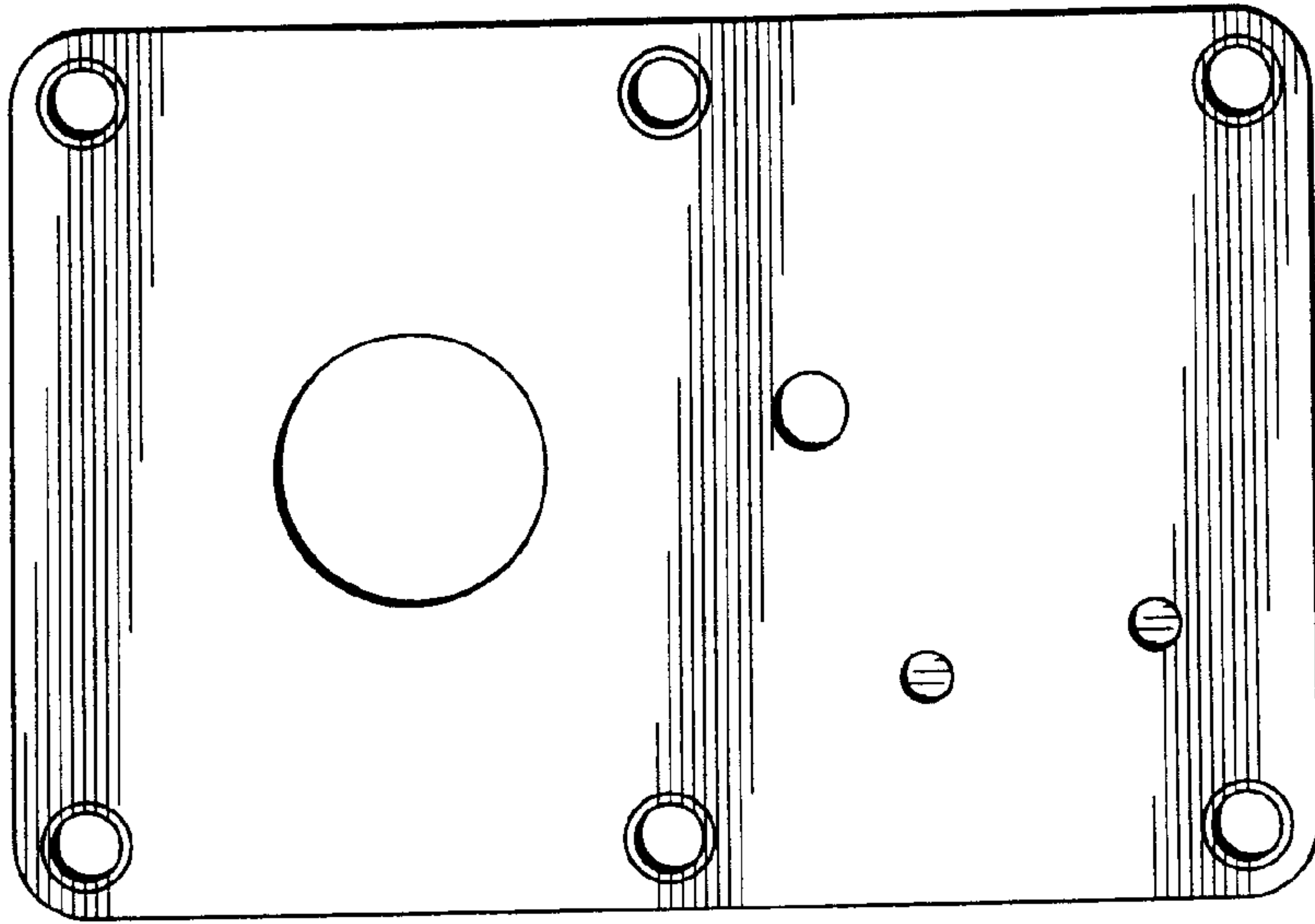

FIG. 20

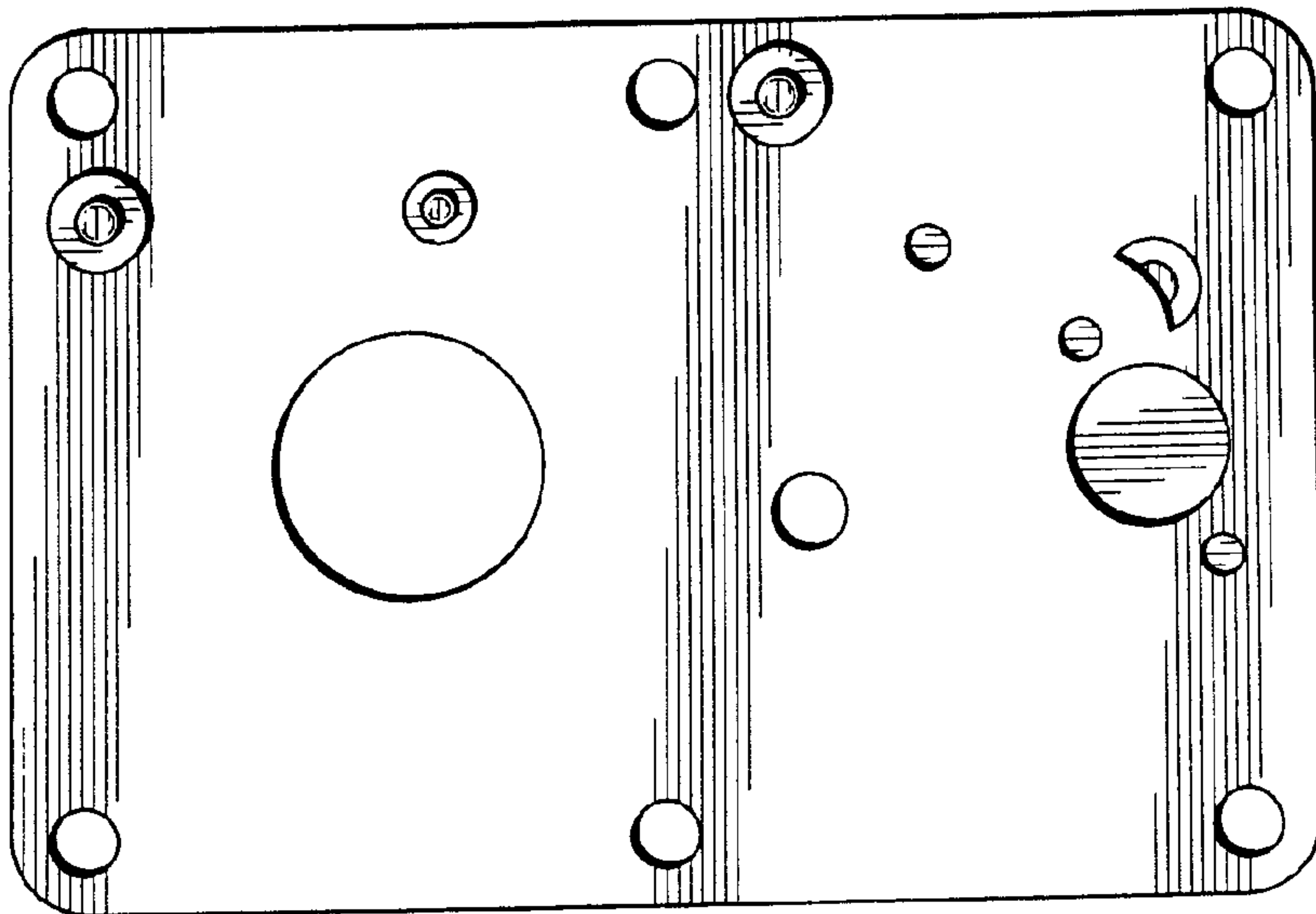

FIG. 19

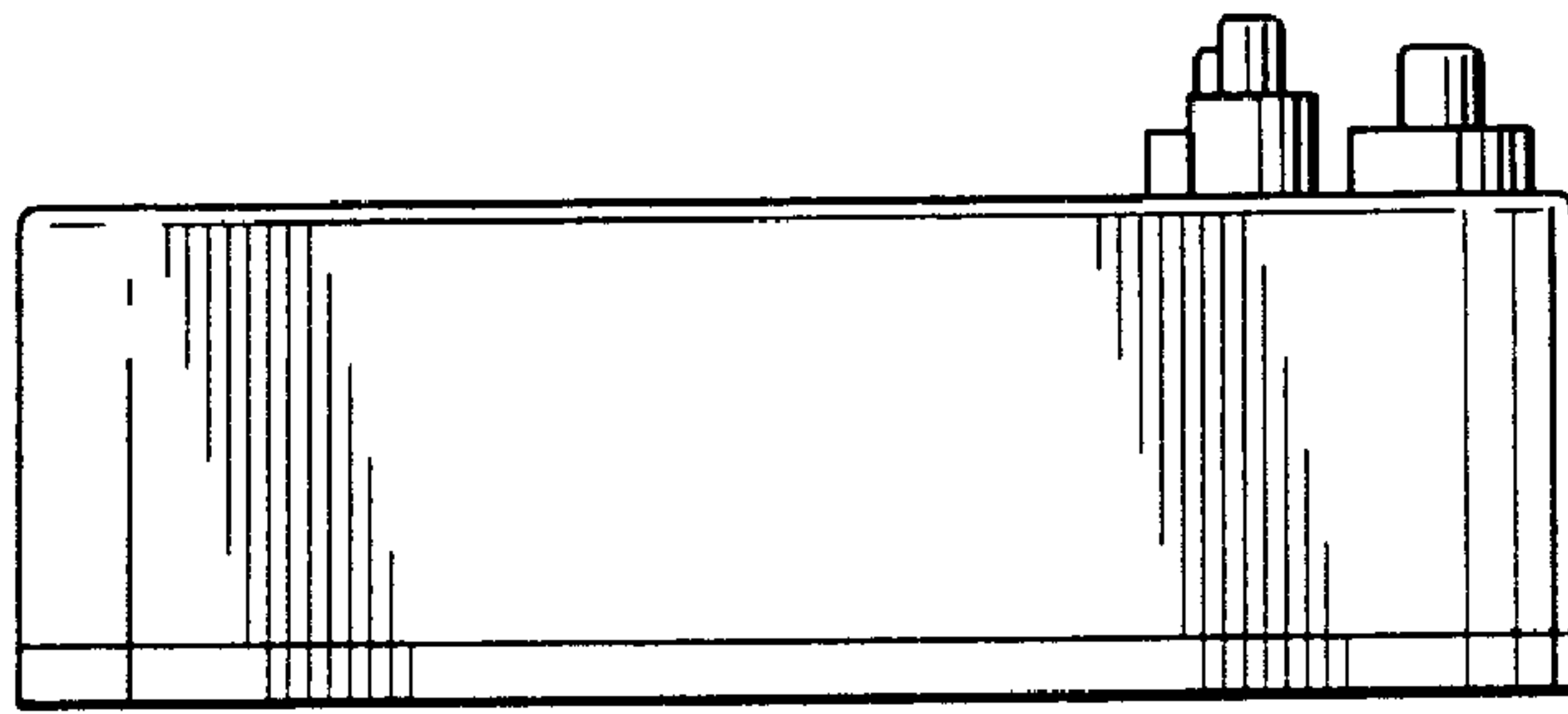

FIG. 21

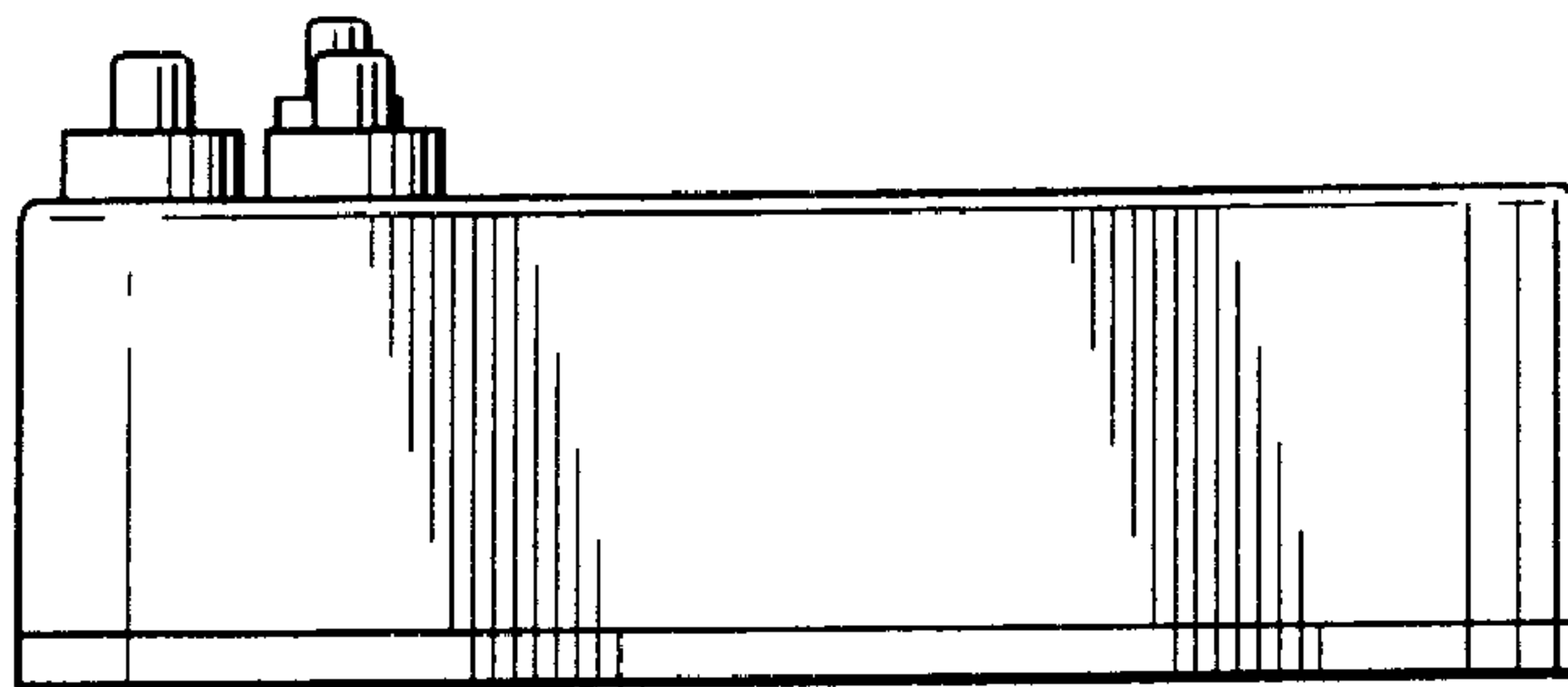

FIG. 22

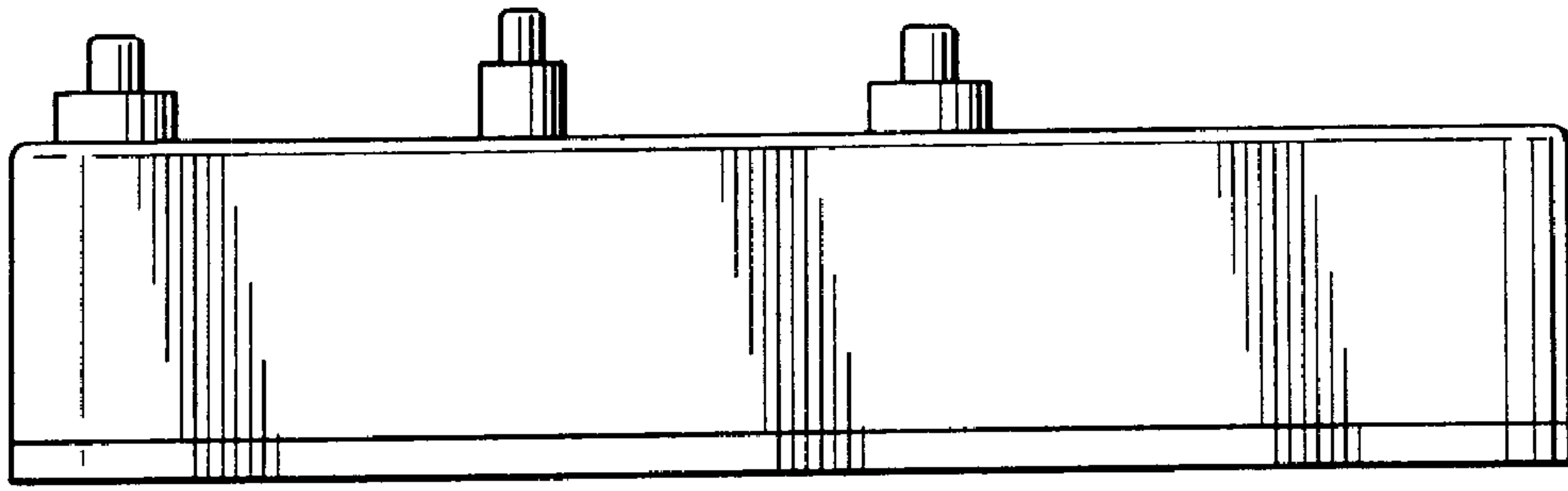

FIG. 23

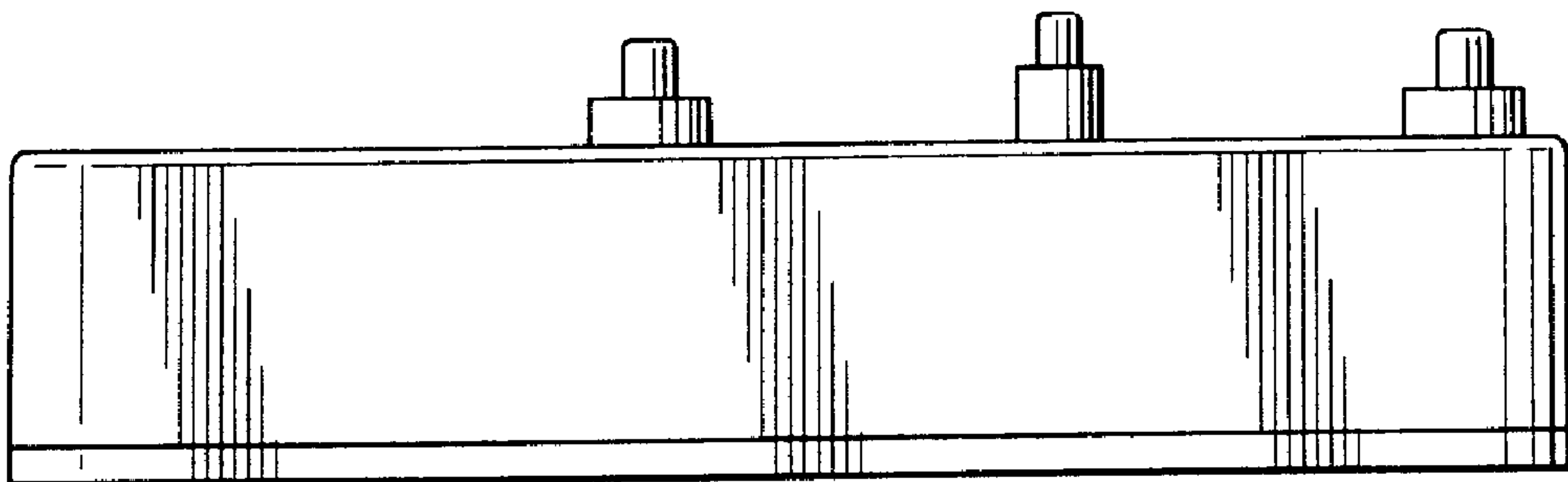

FIG. 24