



US00D475920S

(12) **United States Design Patent**
Poon et al.

(10) **Patent No.:** **US D475,920 S**

(45) **Date of Patent:** **** Jun. 17, 2003**

(54) **CONTAINER CAP**

(75) Inventors: **Christine Dekker Poon**, Cincinnati, OH (US); **Anthony James Burns**, West Chester, OH (US); **David William Schuller**, Lebanon, OH (US)

(73) Assignee: **The Procter & Gamble Company**, Cincinnati, OH (US)

(**) Term: **14 Years**

(21) Appl. No.: **29/159,204**

(22) Filed: **Apr. 17, 2002**

(51) **LOC (7) Cl.** **09-01**

(52) **U.S. Cl.** **D9/445; D9/444; D9/451**

(58) **Field of Search** D9/435, 444, 445, D9/336, 335, 300, 337, 451; 215/200, 316; 220/200

(56) **References Cited**

U.S. PATENT DOCUMENTS

D263,123 S	2/1982	Hadtke et al.	
D296,985 S	* 8/1988	Iwaki	D9/337
D312,574 S	12/1990	Geiger	
D317,869 S	* 7/1991	Kipperman et al.	D9/435
D348,217 S	6/1994	Le Prince	
D403,242 S	* 12/1998	Edwards	D9/337
D408,736 S	4/1999	Wilson et al.	

D418,754 S	1/2000	Hutchinson et al.	
D435,794 S	* 1/2001	Schmidt et al.	D9/451
D438,110 S	* 2/2001	Dailey et al.	D9/445

FOREIGN PATENT DOCUMENTS

CA	88253	11/1999
CA	88254	11/1999
CA	90407	9/2000
CA	94741	2/2002

* cited by examiner

Primary Examiner—Louis S. Zarfes

Assistant Examiner—Gregory Andoll

(74) *Attorney, Agent, or Firm*—Jack L. Oney

(57) **CLAIM**

The ornamental design for a container cap, as shown and described.

DESCRIPTION

FIG. 1 is a perspective view of a container cap, embodying our new design;

FIG. 2 is a rear elevational view thereof;

FIG. 3 is a left side elevational view thereof;

FIG. 4 is a top view thereof;

FIG. 5 is a right side elevational view thereof;

FIG. 6 is a bottom view thereof; and,

FIG. 7 is a front elevational view thereof.

1 Claim, 1 Drawing Sheet



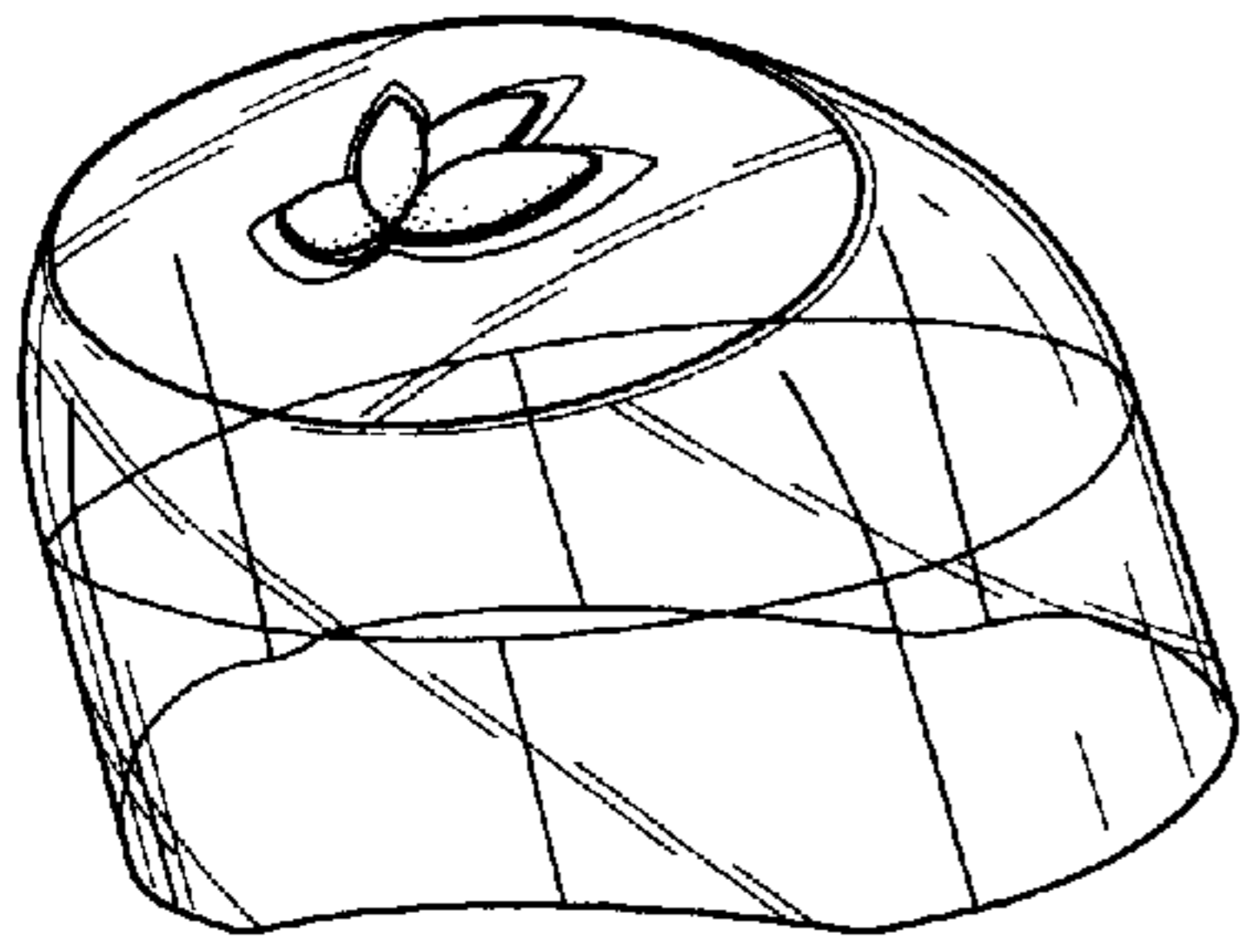

Fig. 1

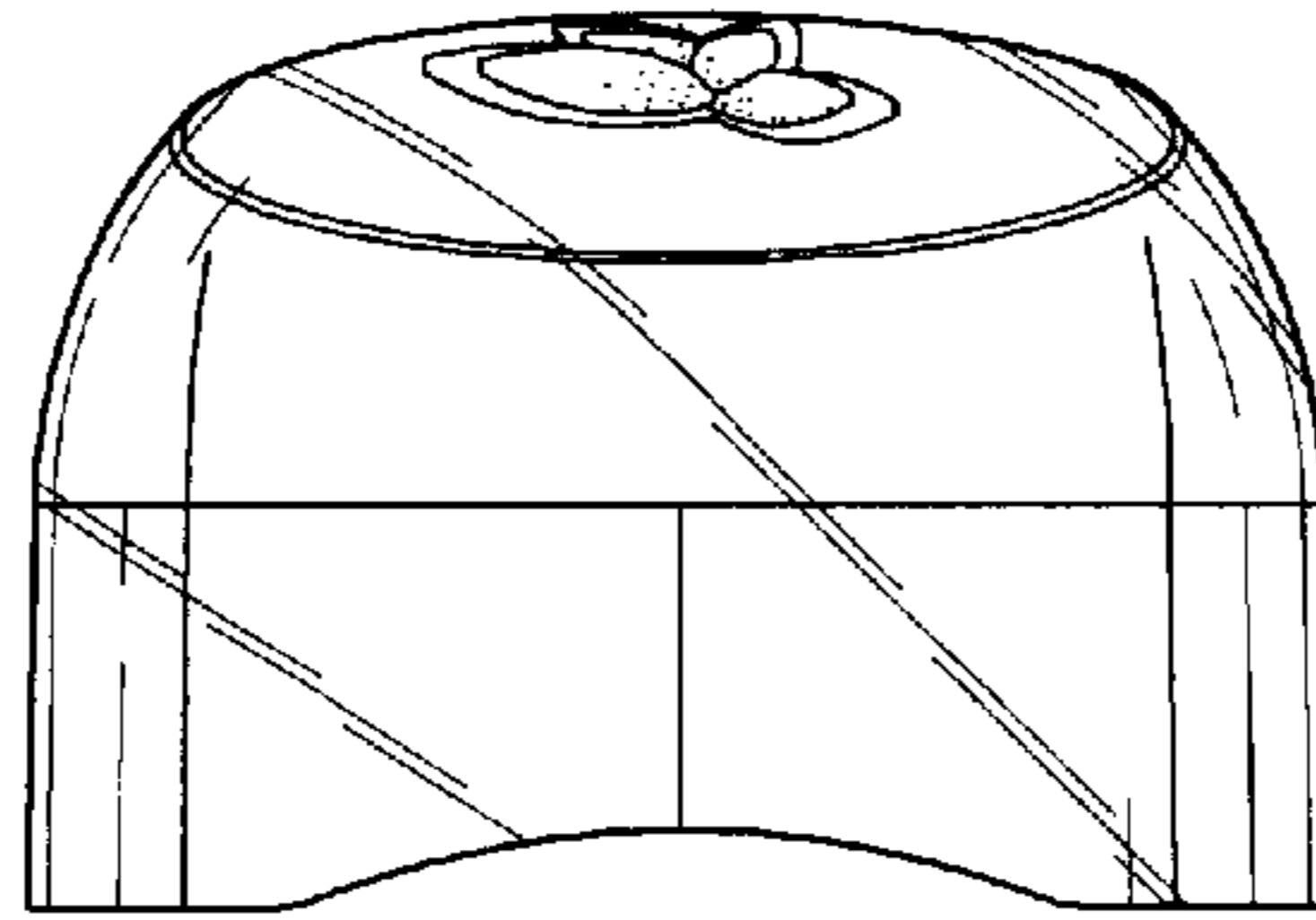

Fig. 2

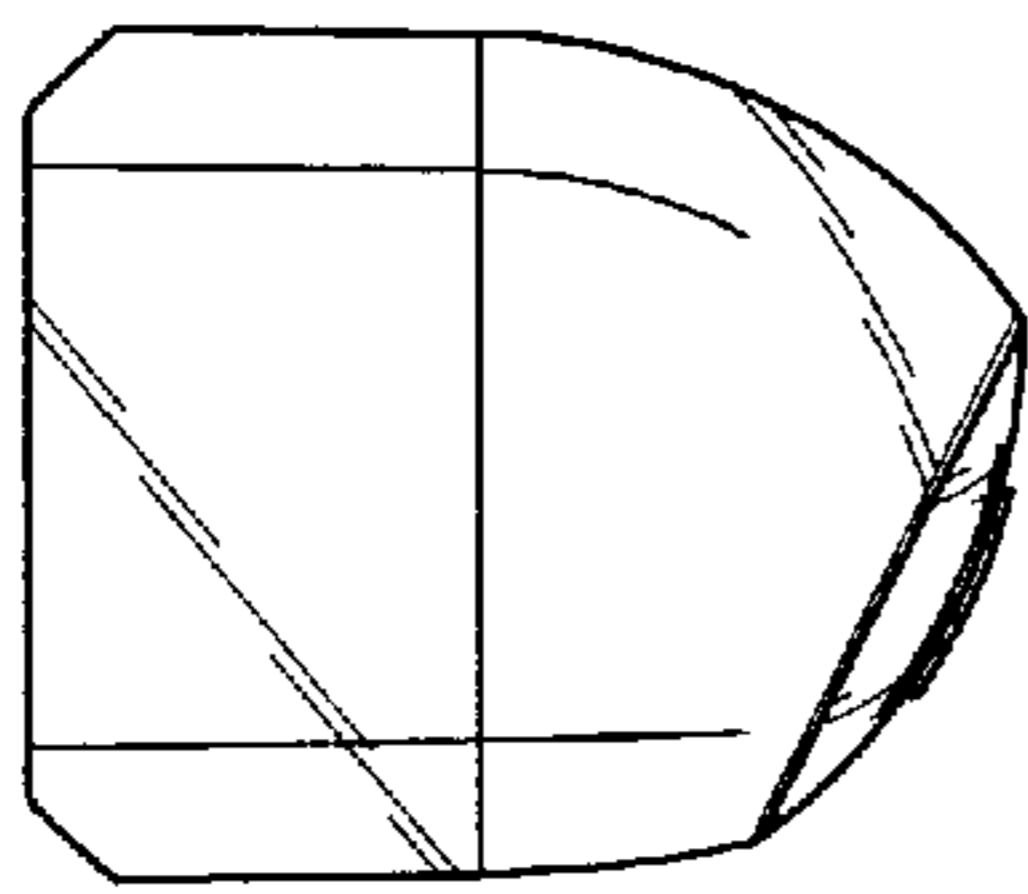

Fig. 3

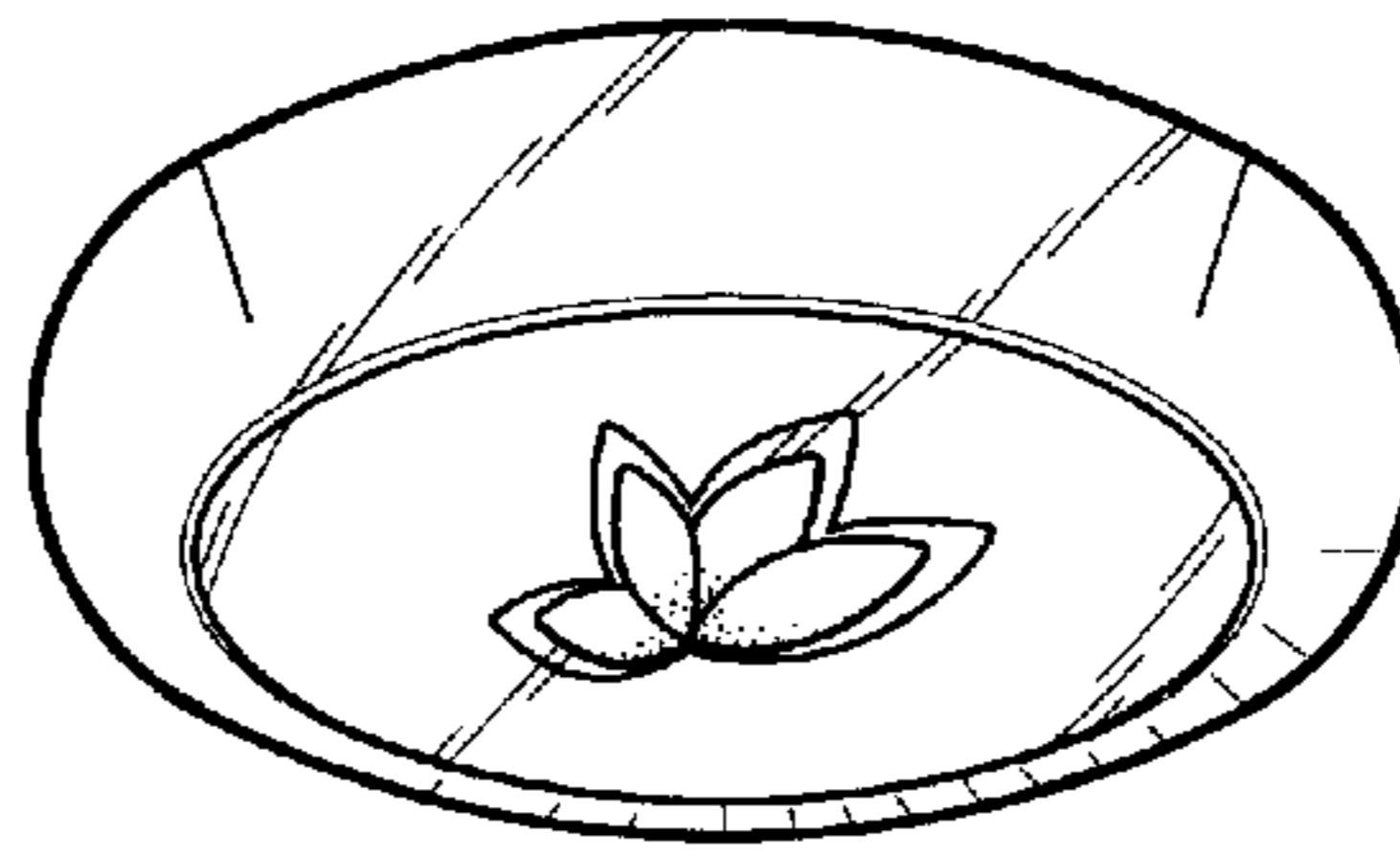

Fig. 4

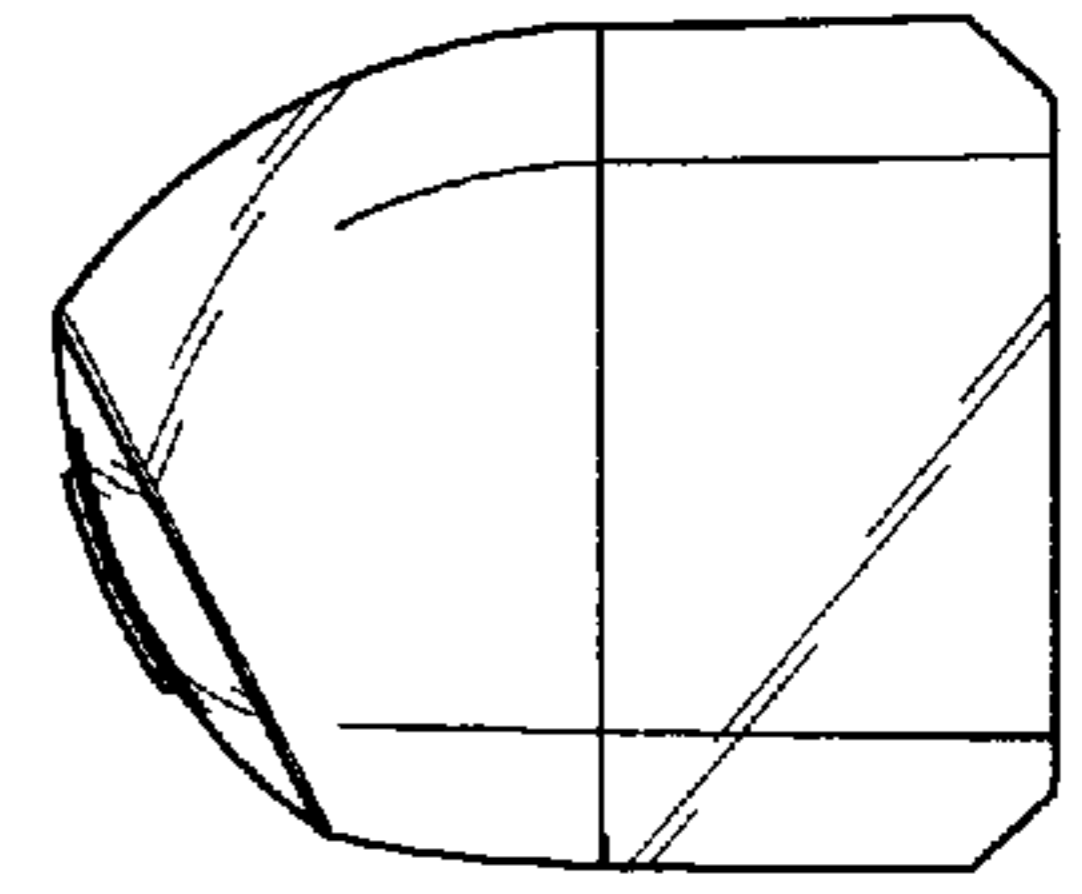

Fig. 5

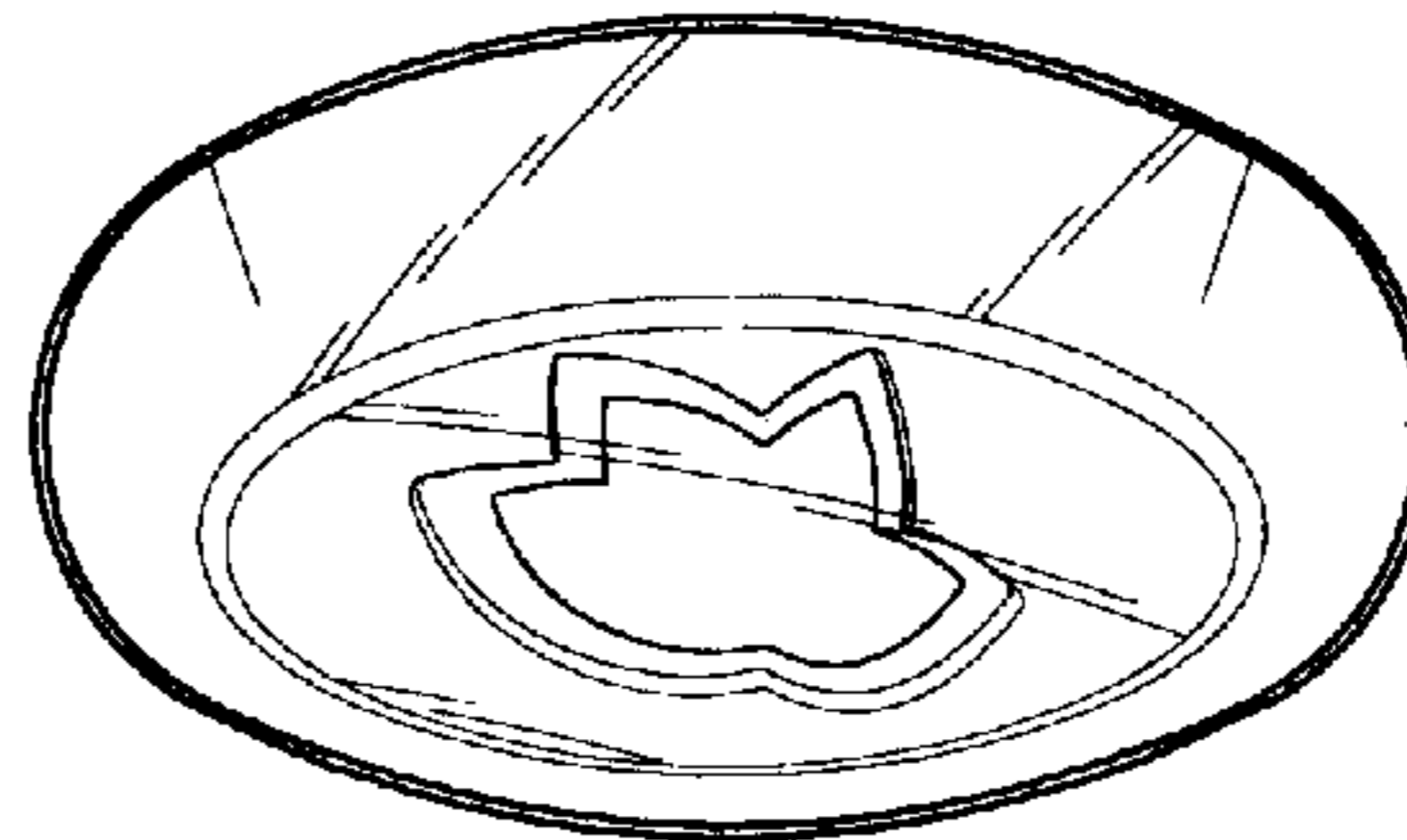

Fig. 6

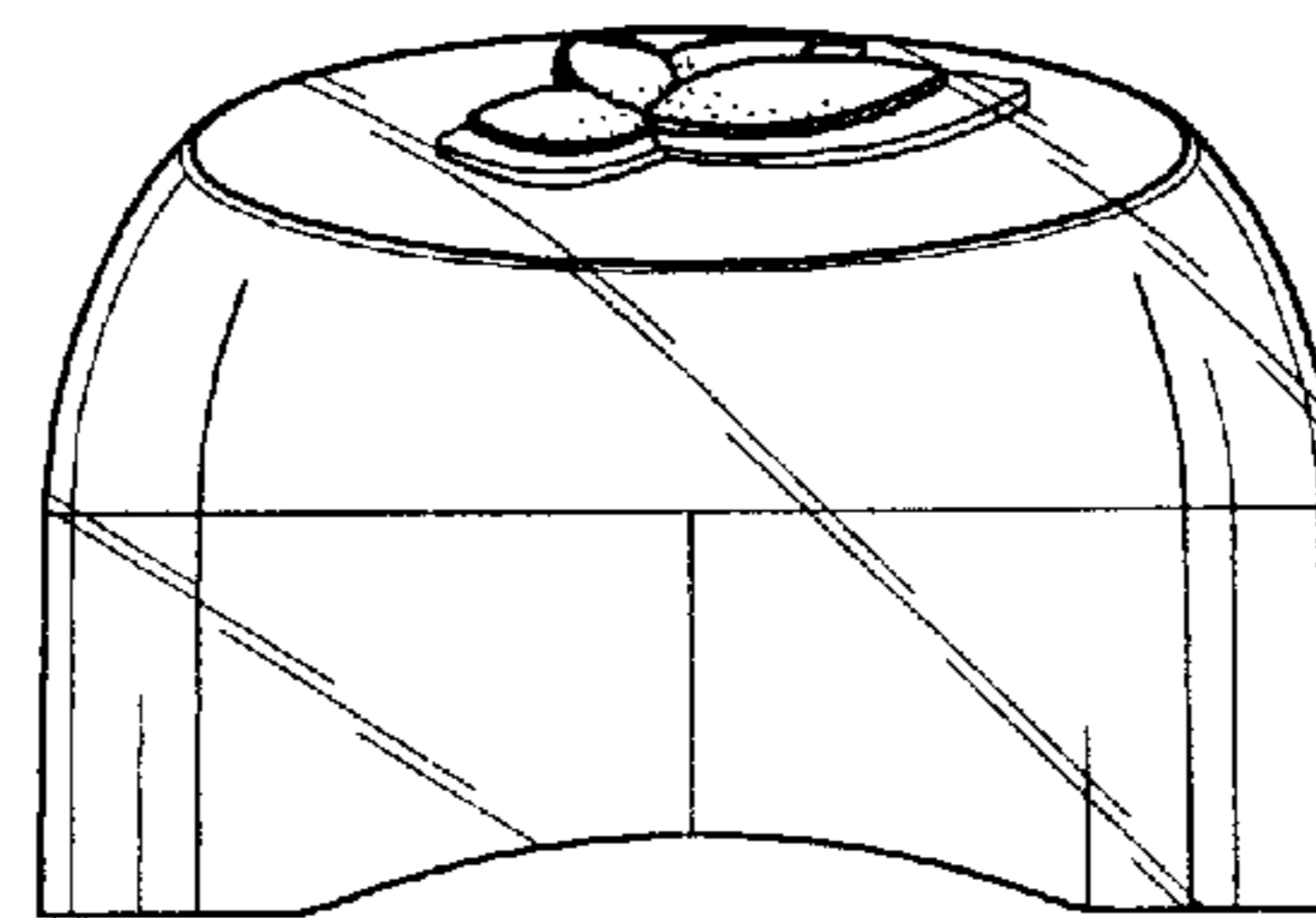

Fig. 7