



US00D475878S

(12) **United States Design Patent**
Knable, III

(10) **Patent No.:** **US D475,878 S**

(45) **Date of Patent:** **** Jun. 17, 2003**

(54) **BALL HOLDER**

(76) **Inventor:** **Elmer Knable, III**, 3005 Fox Hill Dr.,
Floyd Knobs, IN (US) 47119

(**) **Term:** **14 Years**

(21) **Appl. No.:** **29/160,464**

(22) **Filed:** **May 10, 2002**

(51) **LOC (7) Cl.** **08-08**

(52) **U.S. Cl.** **D6/552**

(58) **Field of Search** D6/552, 553, 567,
D6/569, 574; 206/315.9, 315.91, 557; 211/13.1,
14, 68, 69, 69.5, 70.2, 70.6, 71.01, 75,
86.01, 87.01, 88.03, 90.01, 134; 248/309.1,
311.2, 314

(56) **References Cited**

U.S. PATENT DOCUMENTS

3,368,689	A	2/1968	Porterfield	
D242,402	S	* 11/1976	Bratene et al. D6/552 X
4,002,241	A	1/1977	Parrilla, Sr.	
4,077,514	A	3/1978	Kubokawa	
D248,342	S	7/1978	Young	
D248,809	S	8/1978	Kailey	
4,214,684	A	7/1980	Galowitz	
4,256,244	A	3/1981	Gasper	
D282,704	S	2/1986	Burnett	
D333,214	S	2/1993	Stewart, Jr. et al.	
5,186,374	A	2/1993	Buxton	
5,232,101	A	8/1993	Shaftner et al.	
5,386,906	A	2/1995	Lai	
D363,520	S	* 10/1995	Melillo D3/224
D375,406	S	11/1996	Smith	
D394,154	S	5/1998	Smith	

5,855,286	A	*	1/1999	Zaid	211/14
5,894,951	A		4/1999	Hunt		
5,988,433	A		11/1999	Crum		
D419,632	S		1/2000	Ashcroft		
6,158,593	A		12/2000	Olsen		
6,267,461	B1		7/2001	Dunagan et al.		

OTHER PUBLICATIONS

Skymall.com—Continental Airlines Catalogue “Basketball Bin” Jan. 14, 2002.

* cited by examiner

Primary Examiner—Brian N. Vinson

(74) *Attorney, Agent, or Firm*—Camoriano and Associates;
Theresa Fritz Camoriano

(57) **CLAIM**

The ornamental design for a ball holder, as shown and described.

DESCRIPTION

FIG. 1 is a top perspective view of a ball holder showing my design;
FIG. 2 is a bottom perspective view thereof, shown in broken lines;
FIG. 3 is a top view thereof;
FIG. 4 is a bottom view thereof, shown in broken lines;
FIG. 5 is a right side view thereof, which is a mirror image of the left side view;
FIG. 6 is a front view thereof; and,
FIG. 7 is a rear view thereof.
The bottom views are shown in broken lines as not being a part of the claimed design.

1 Claim, 3 Drawing Sheets

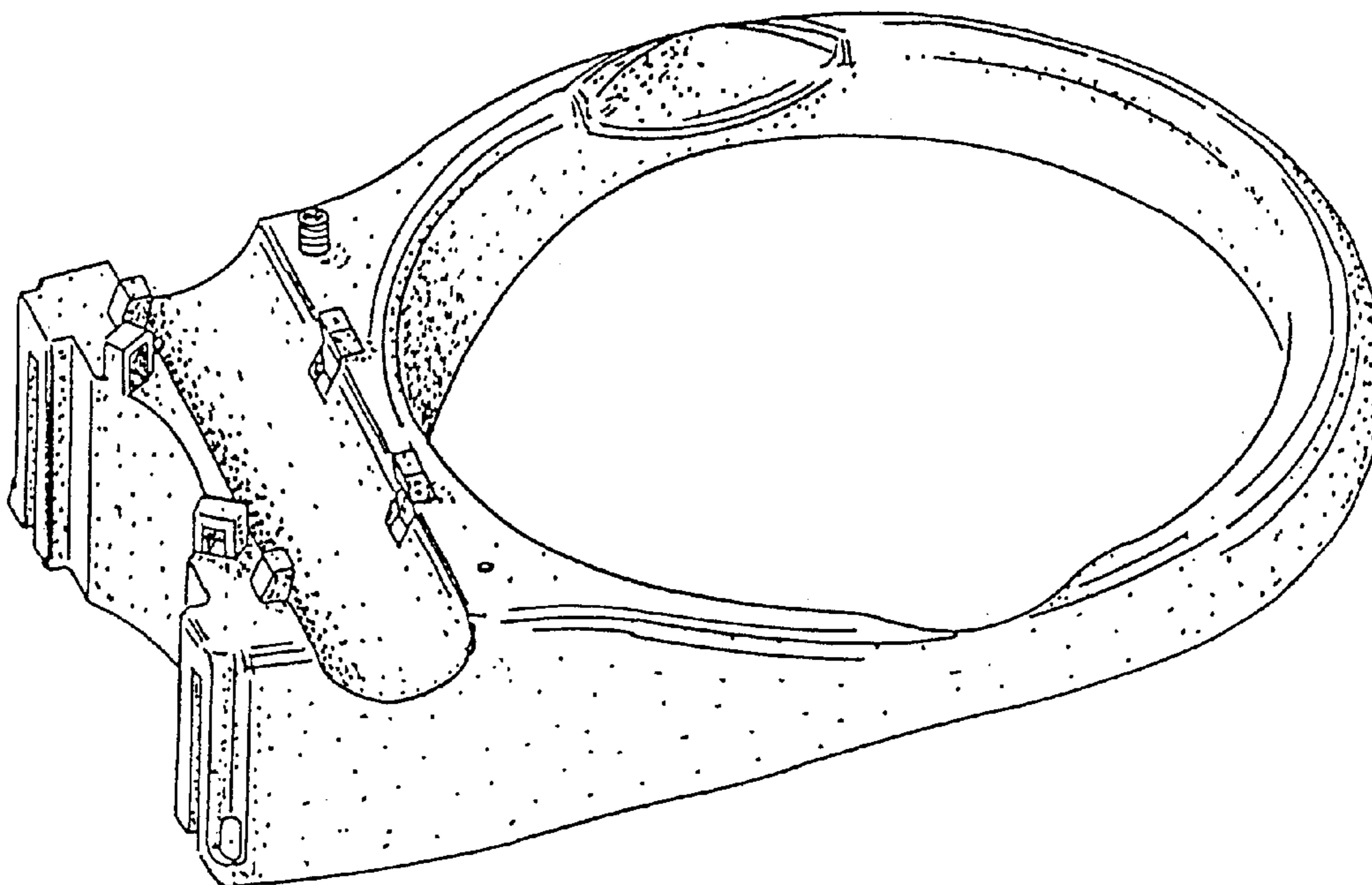

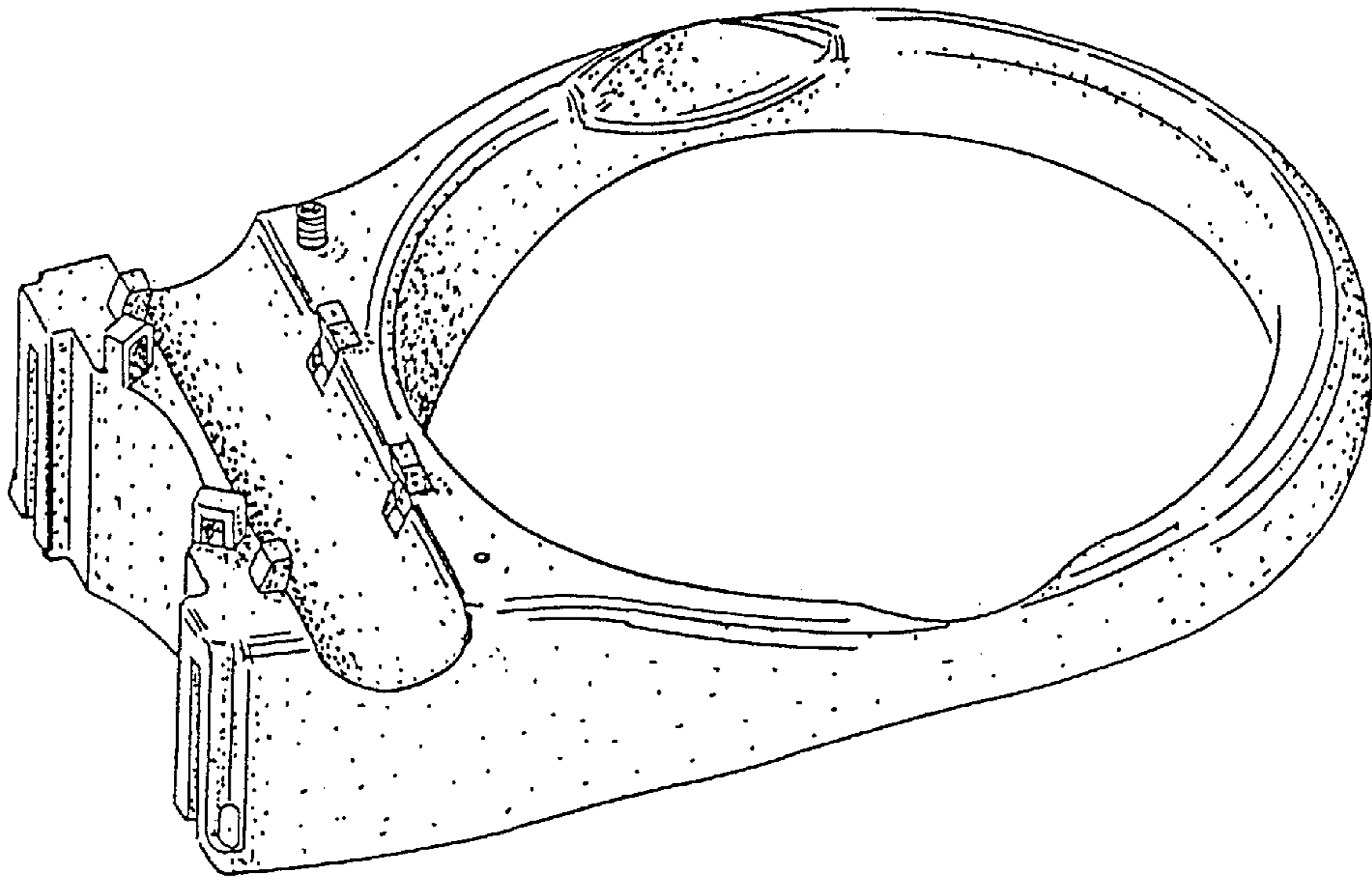

FIG. 1

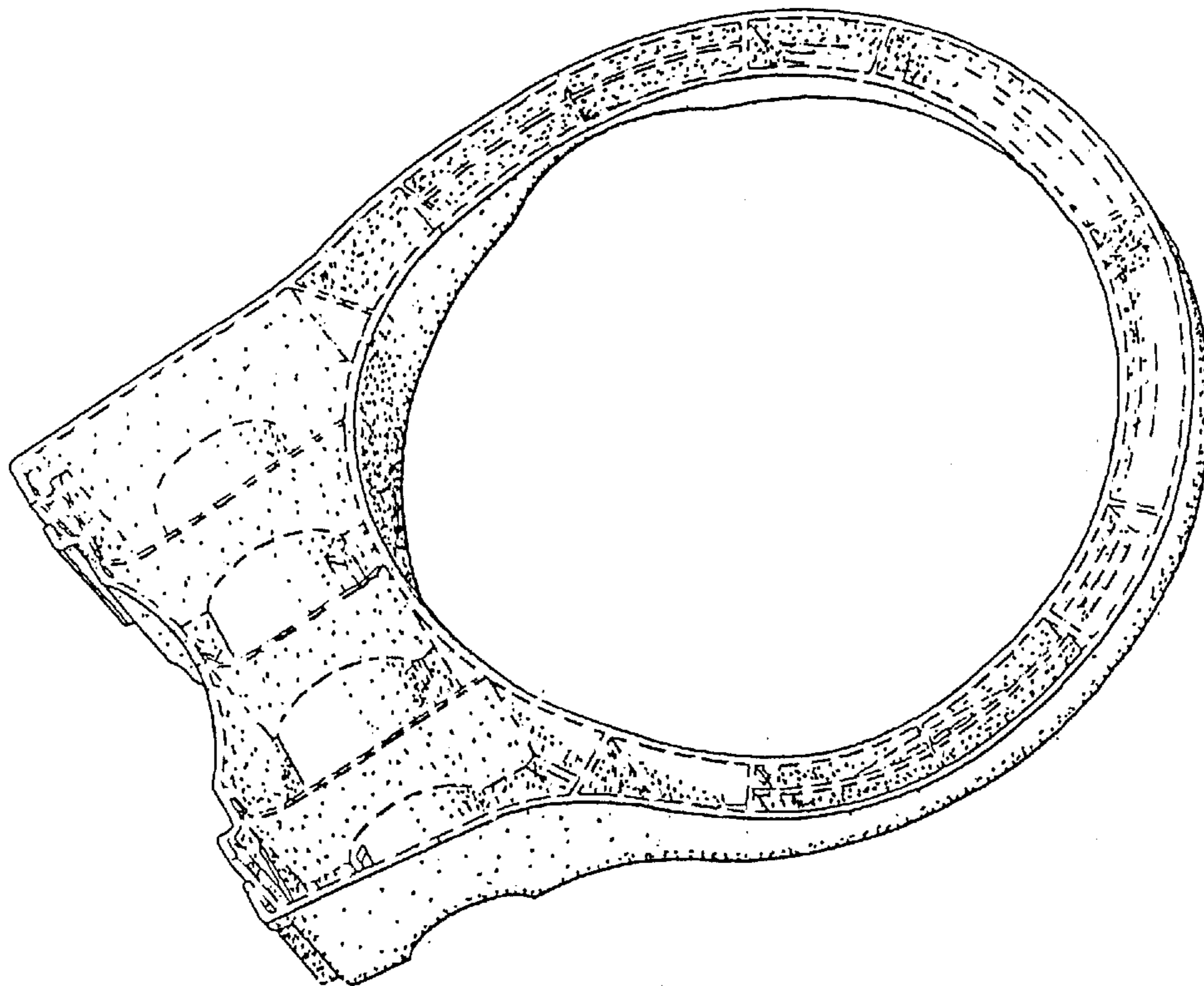

FIG. 2

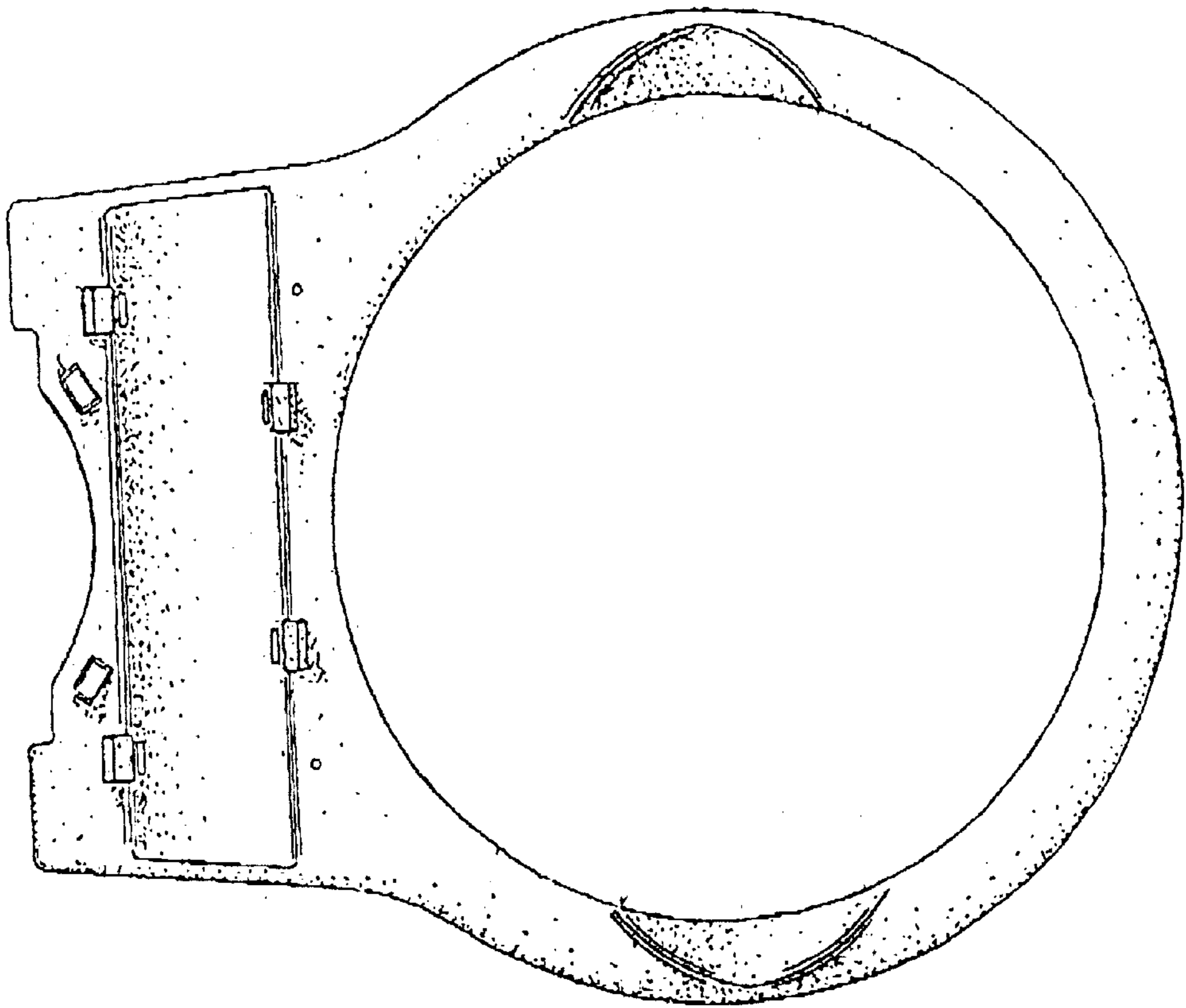

FIG. 3

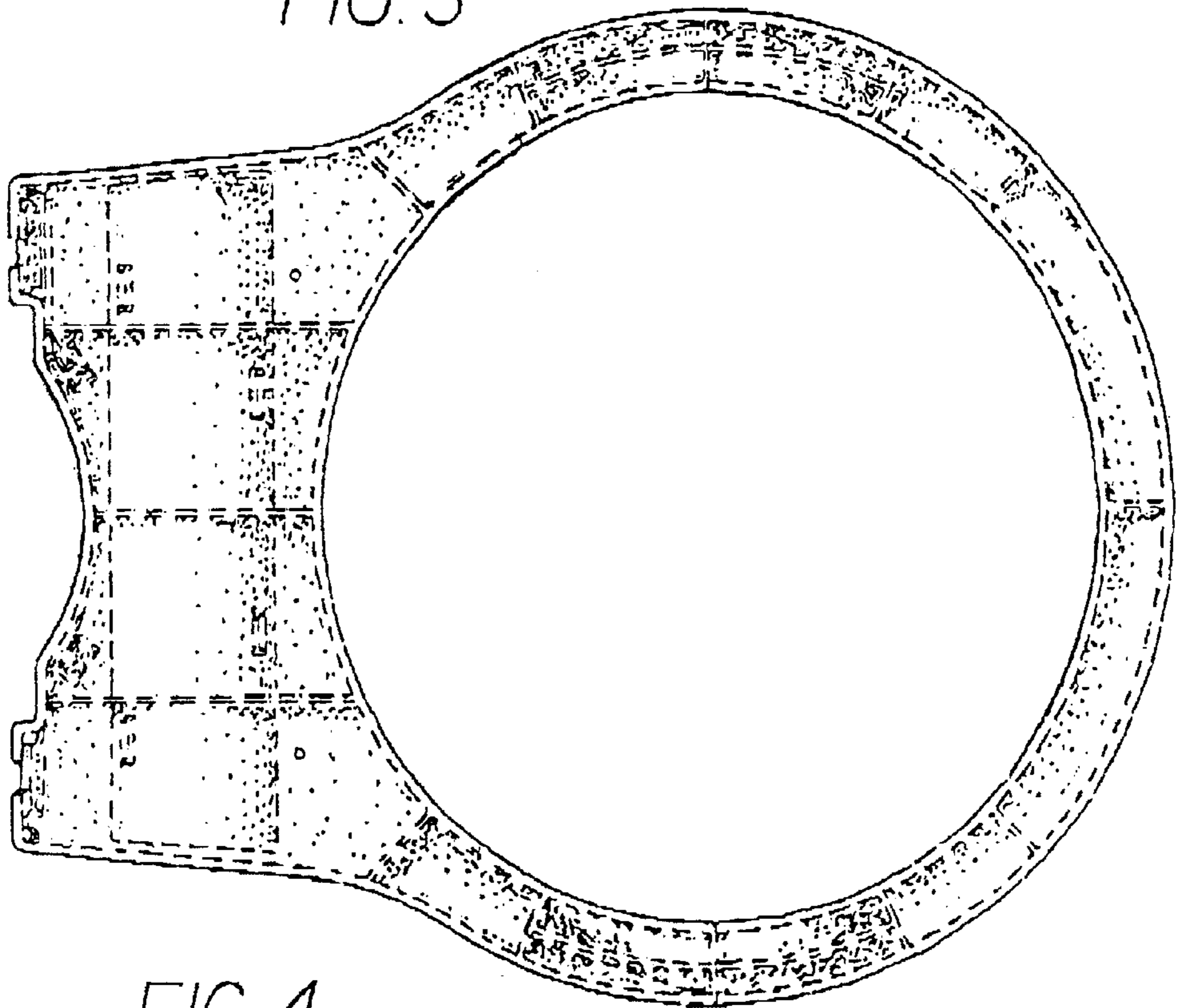

FIG. 4

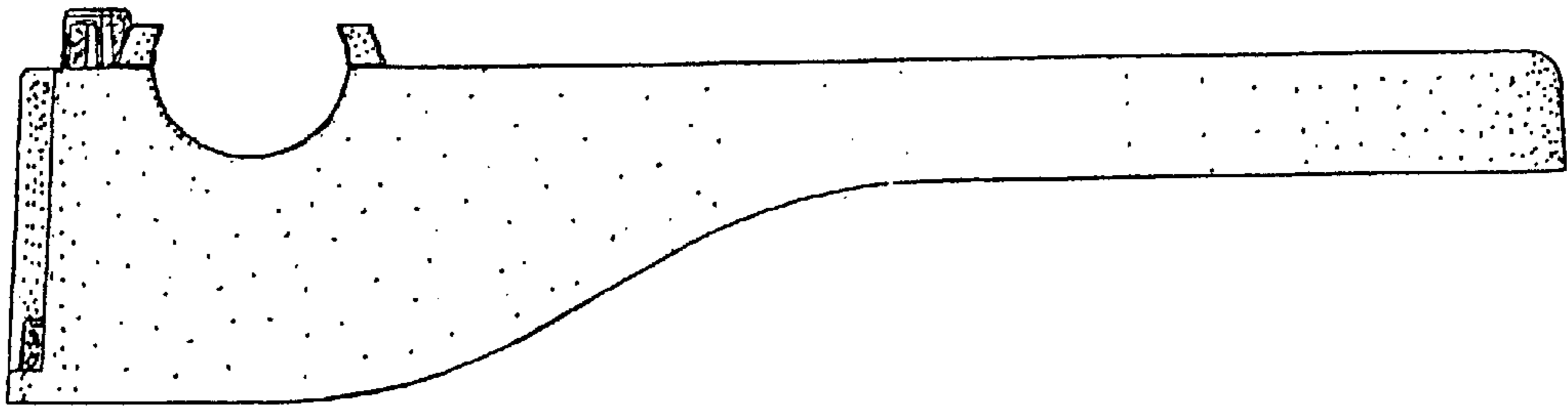

FIG. 5

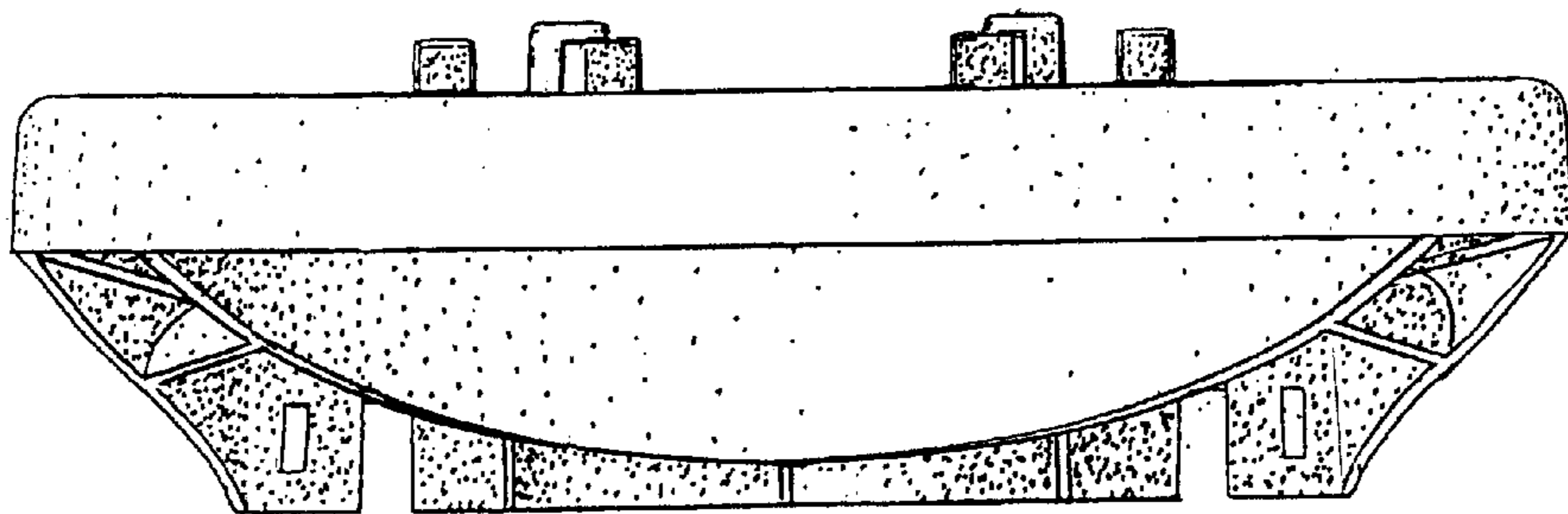

FIG. 6

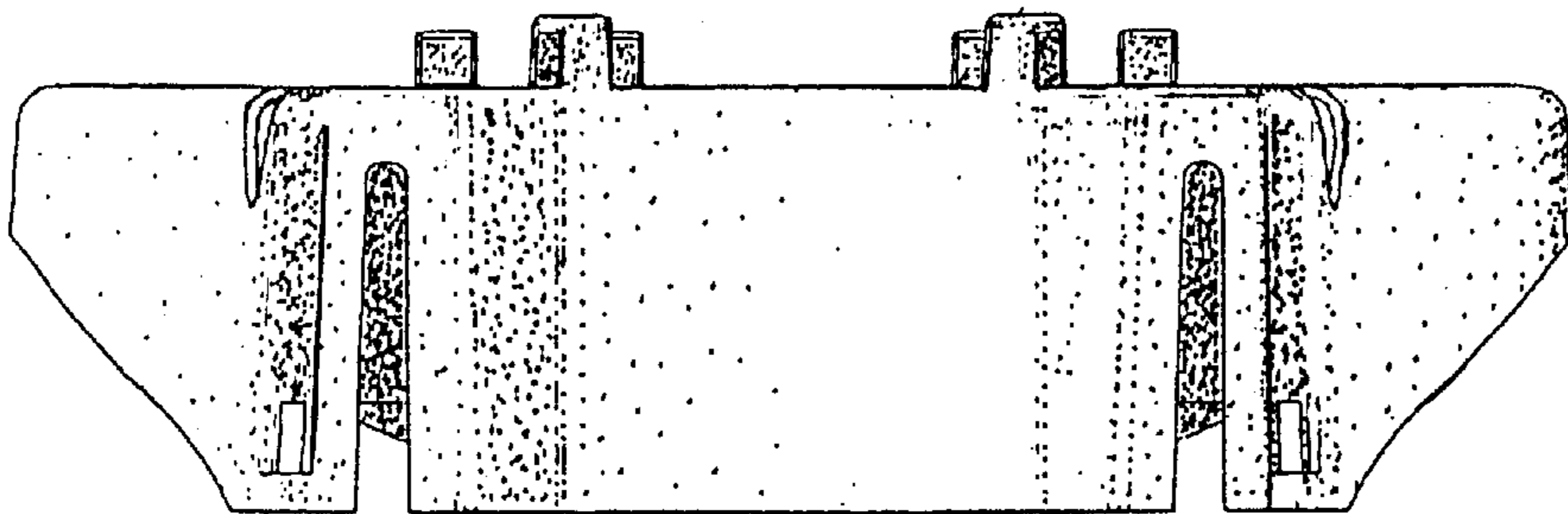

FIG. 7