



US00D475876S

(12) **United States Design Patent**
Chen

(10) **Patent No.:** **US D475,876 S**

(45) **Date of Patent:** **** Jun. 17, 2003**

(54) **LIQUID CONTAINER**

(75) Inventor: **Cheng Feng Chen, Chong Ho (TW)**

(73) Assignee: **Bobson Hygiene International Inc., Taipei (TW)**

(**) Term: **14 Years**

(21) Appl. No.: **29/171,510**

(22) Filed: **Nov. 21, 2002**

(51) **LOC (7) Cl.** **23-02**

(52) **U.S. Cl.** **D6/545**

(58) **Field of Search** D6/542, 545; 222/173, 222/180, 181.1, 181.3; 221/282, 283; 206/77.1

(56) **References Cited**

U.S. PATENT DOCUMENTS

- D372,824 S * 8/1996 Lin et al. D6/545
- D379,728 S * 6/1997 Simon D6/545
- D387,597 S * 12/1997 Kearnes D6/545

- D392,137 S * 3/1998 Vignot D6/545
- D418,344 S * 1/2000 De Winter D6/545
- D426,094 S * 6/2000 Carlson D6/545
- D448,958 S * 10/2001 Gross D6/545

* cited by examiner

Primary Examiner—Brian N. Vinson

(57) **CLAIM**

The ornamental design for a liquid container, as shown and described.

DESCRIPTION

FIG. 1 is a perspective view of a liquid container showing my new design;
 FIG. 2 is a front elevational view thereof;
 FIG. 3 is a rear elevational view thereof;
 FIG. 4 is a top plan view thereof;
 FIG. 5 is a bottom plan view thereof;
 FIG. 6 is a left side elevational view thereof; and,
 FIG. 7 is a right side elevational view thereof.

1 Claim, 4 Drawing Sheets

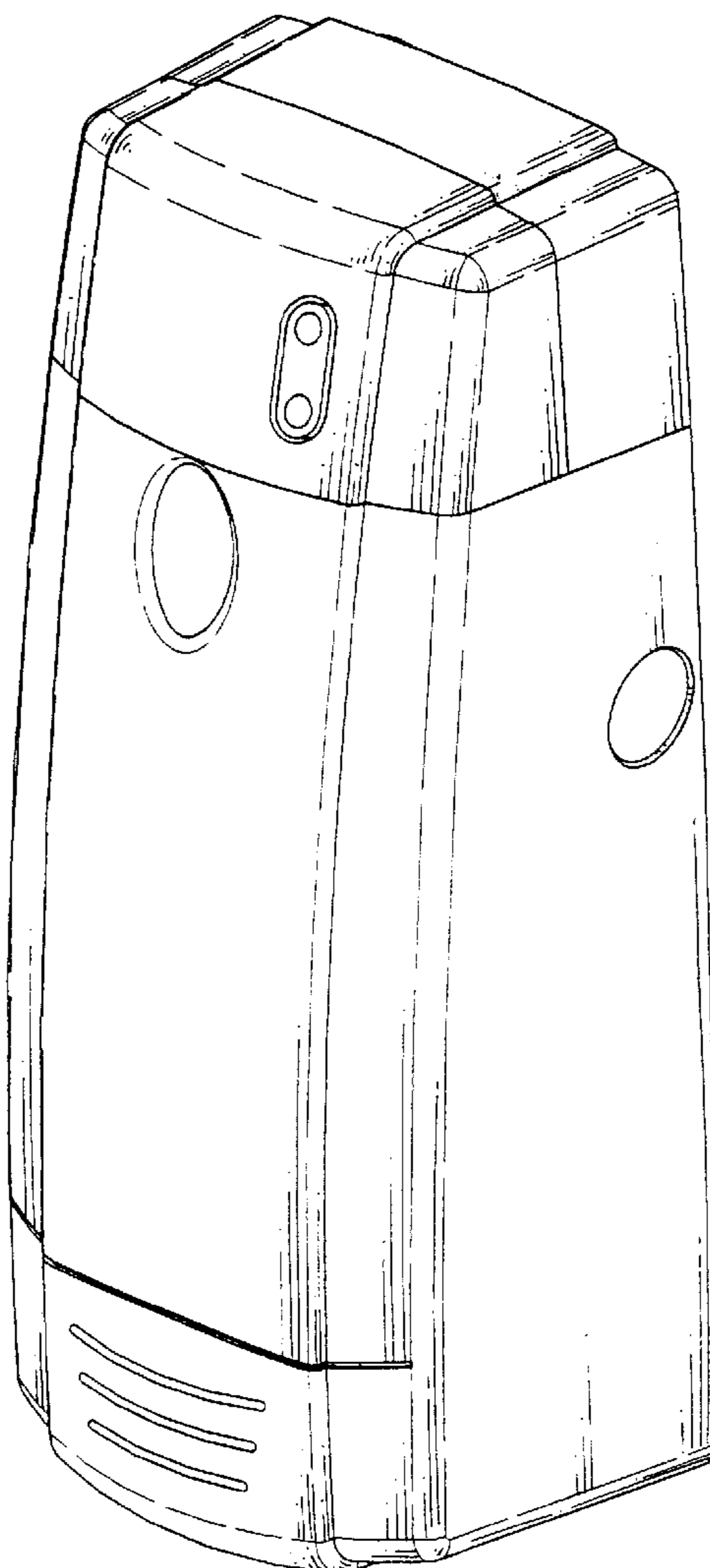

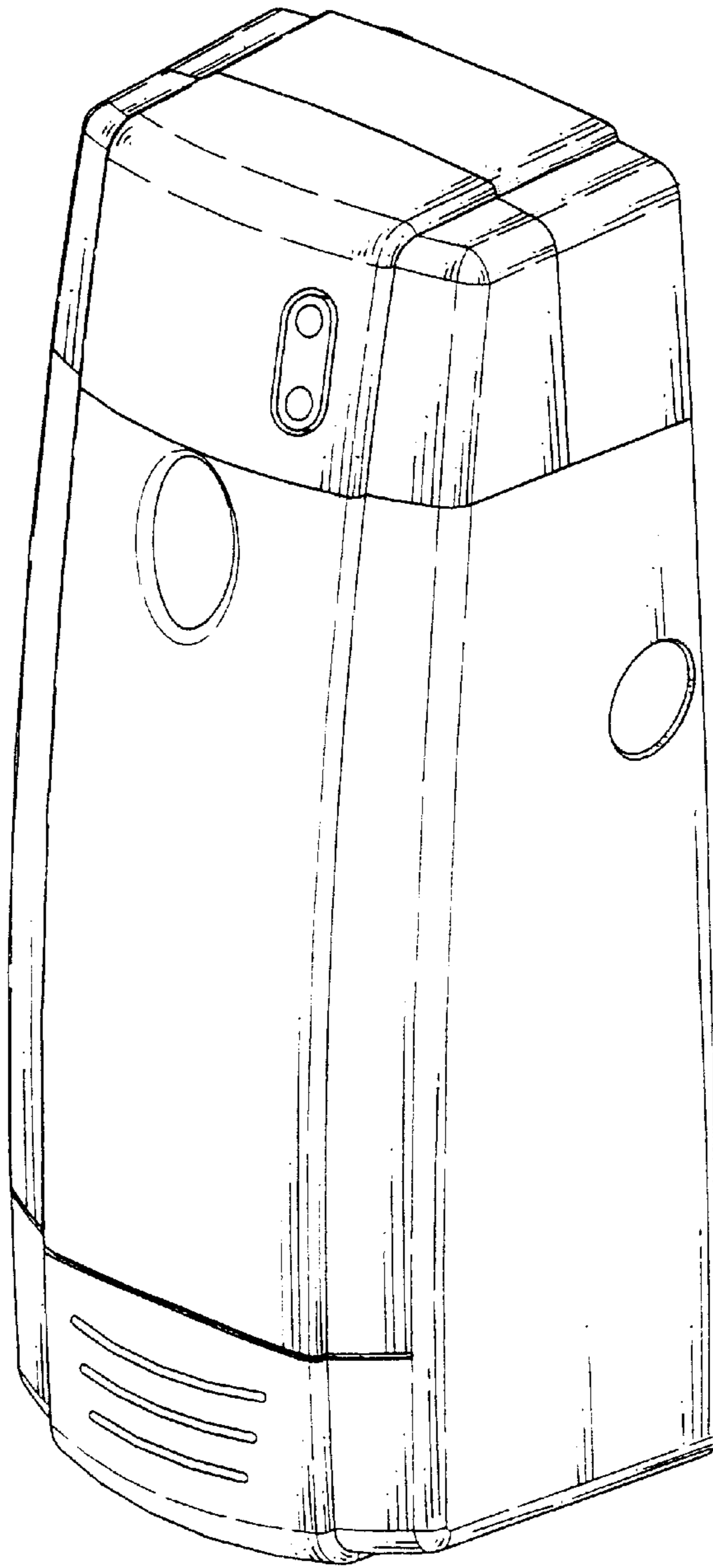

FIG. 1

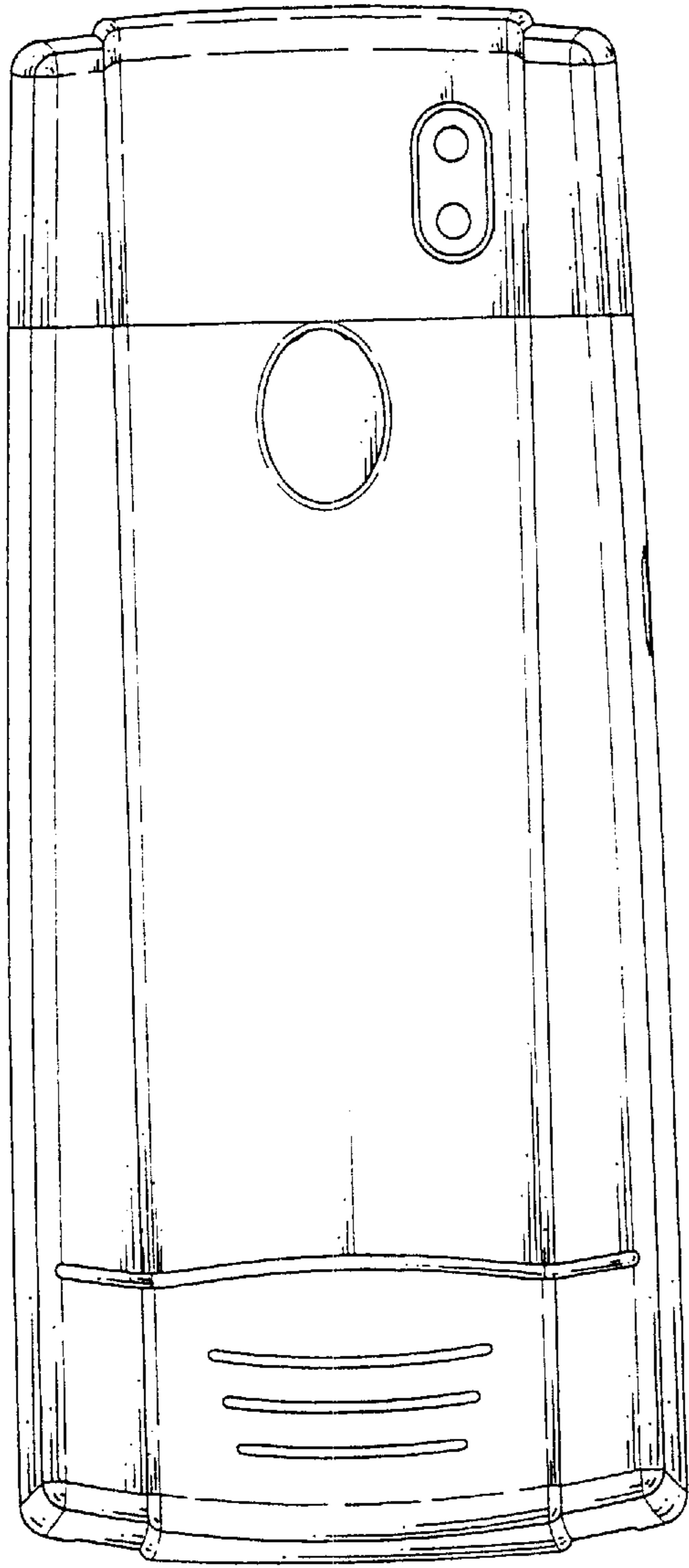

FIG. 2

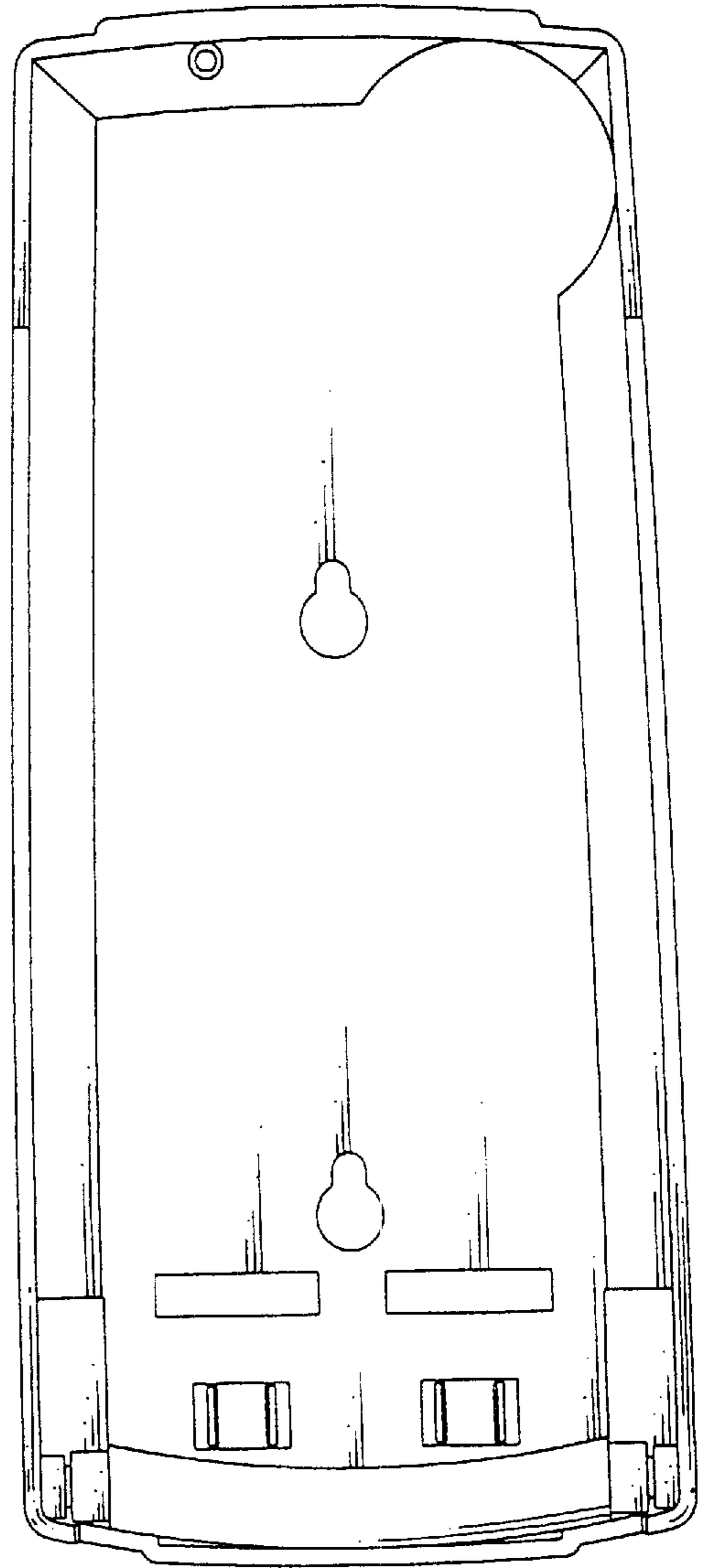

FIG. 3

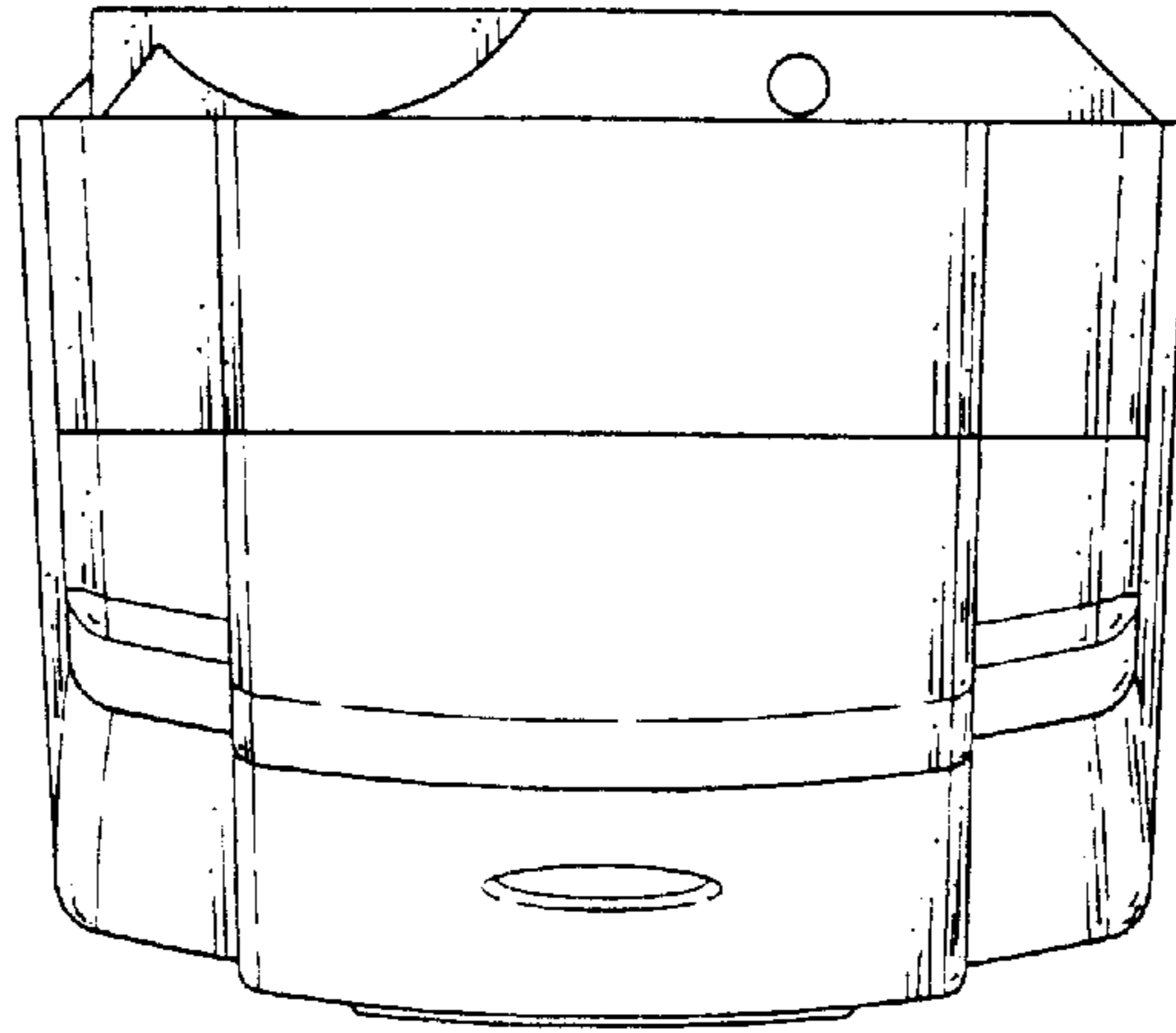

FIG. 4

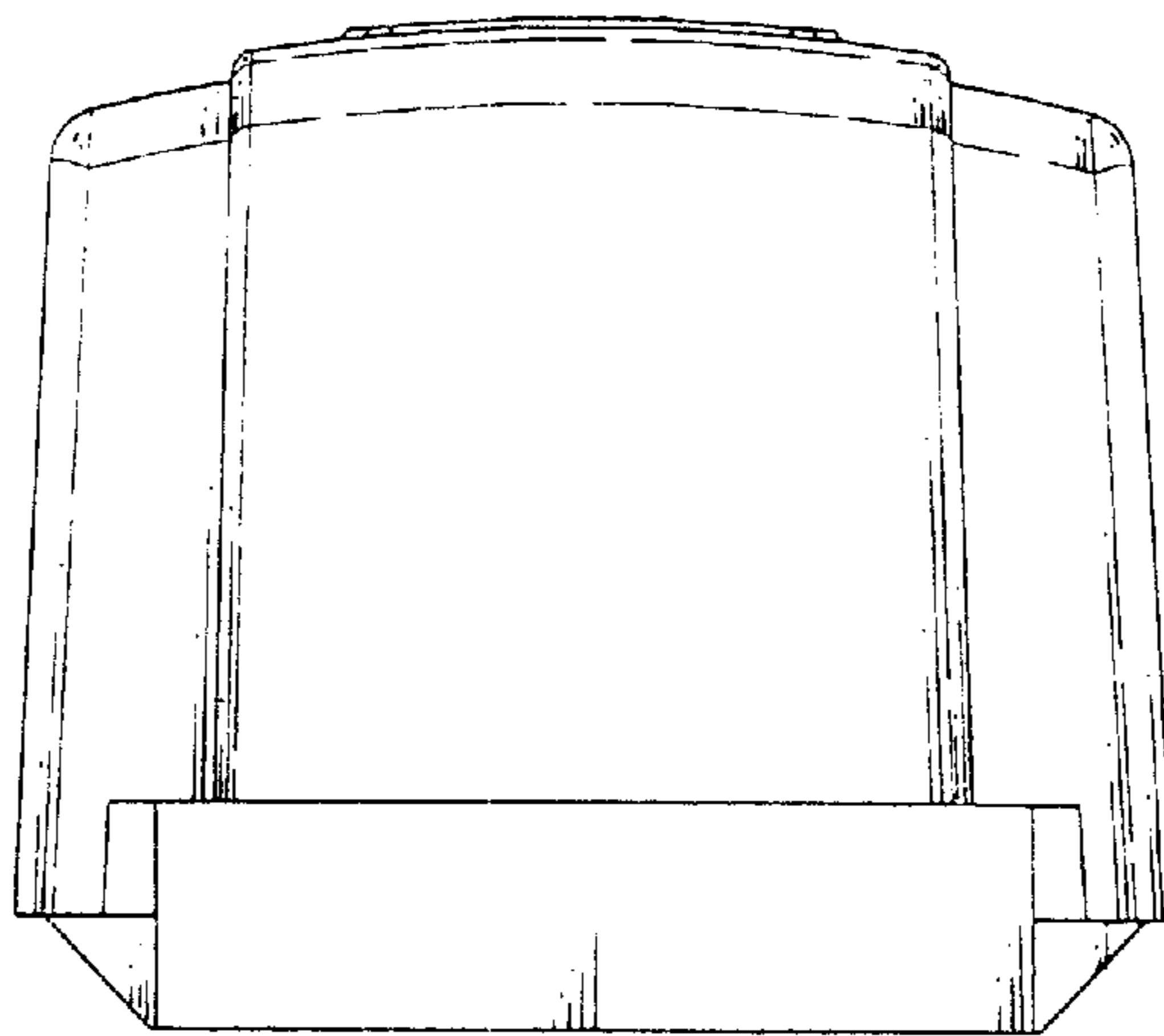

FIG. 5

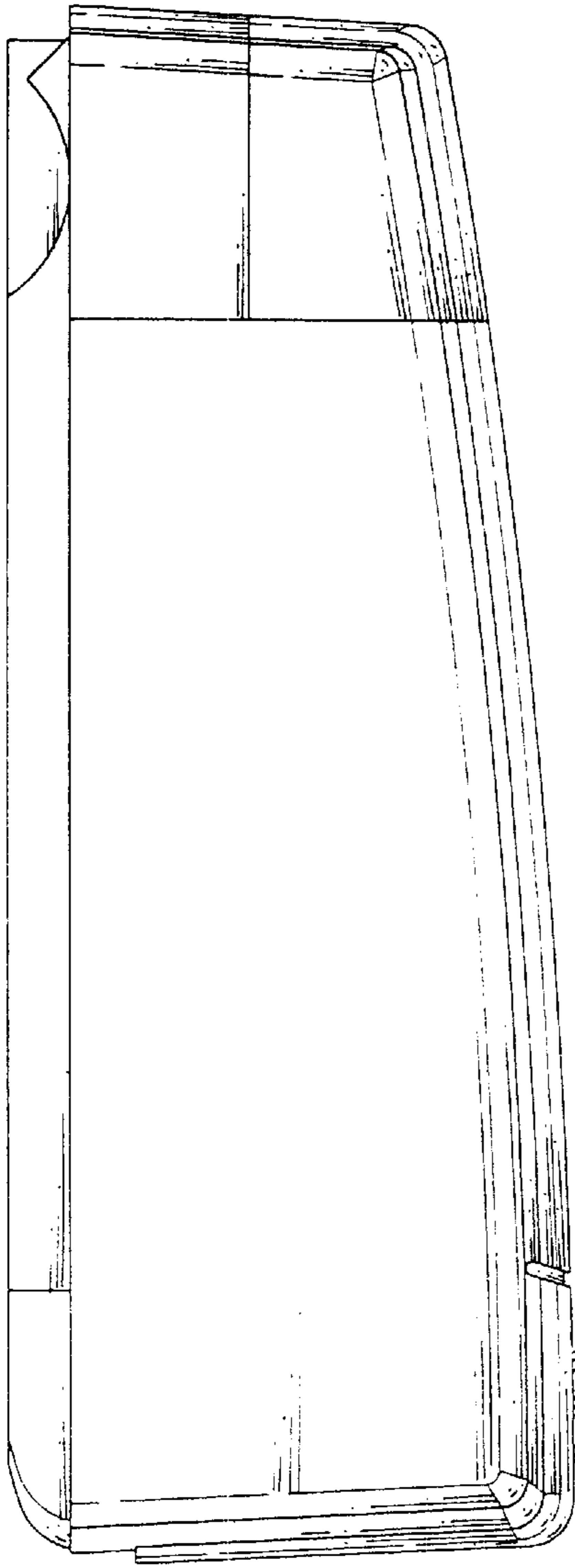

FIG. 6

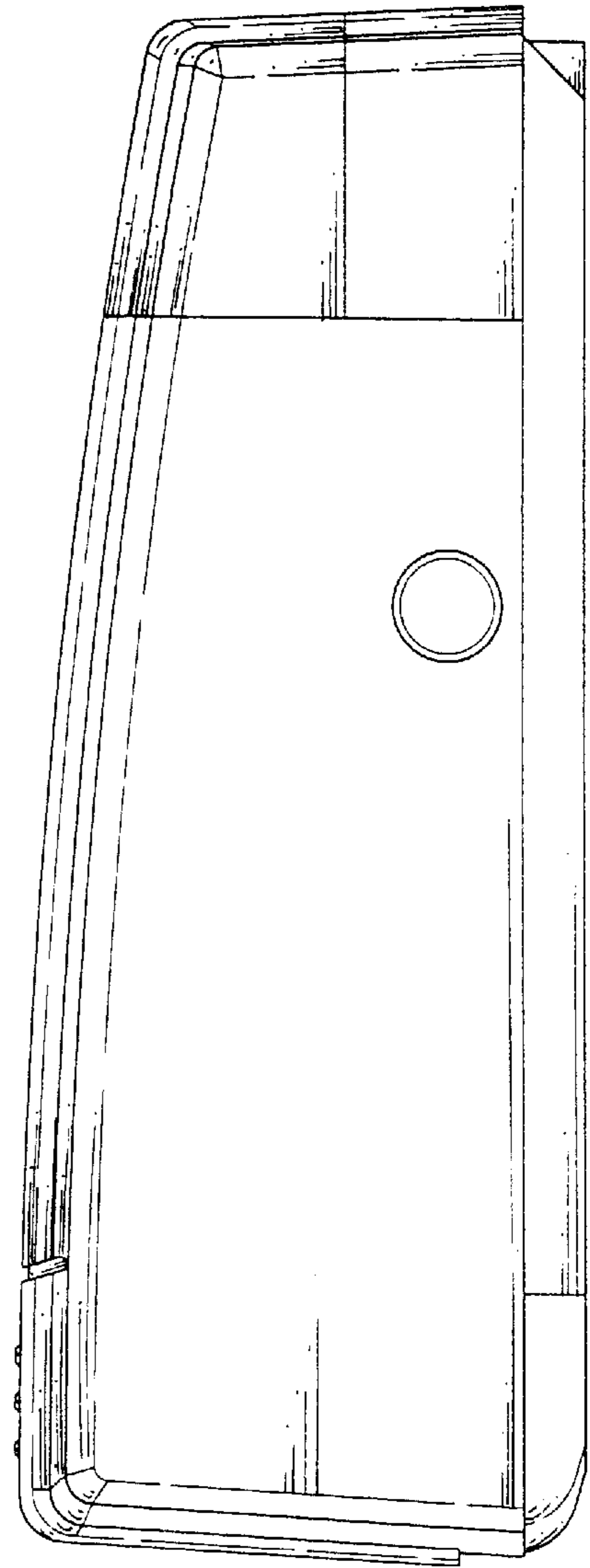

FIG. 7