



US00D475872S

(12) **United States Design Patent**  
**Picone**

(10) **Patent No.:** **US D475,872 S**

(45) **Date of Patent:** **\*\* Jun. 17, 2003**

(54) **MAGNETIC LOCKER DRAWER**

4,971,390 A \* 11/1990 McGinley ..... 297/188.11  
D326,381 S \* 5/1992 Heiligenthal et al. .... D6/510

(76) Inventor: **Anthony Picone**, 9319 Boston State Rd., Boston, NY (US) 14025

\* cited by examiner

(\*\*) Term: **14 Years**

*Primary Examiner*—Cathron C. Brooks  
(74) *Attorney, Agent, or Firm*—Harpman & Harpman

(21) Appl. No.: **29/164,579**

(57) **CLAIM**

(22) Filed: **Jul. 29, 2002**

The ornamental design for a magnetic locker drawer, as shown and described.

(51) **LOC (7) Cl.** ..... **06-06**

(52) **U.S. Cl.** ..... **D6/510**

(58) **Field of Search** ..... D6/396, 397, 491,  
D6/509, 510; 312/249.8, 249.11, 293.2,  
249.2, 245

**DESCRIPTION**

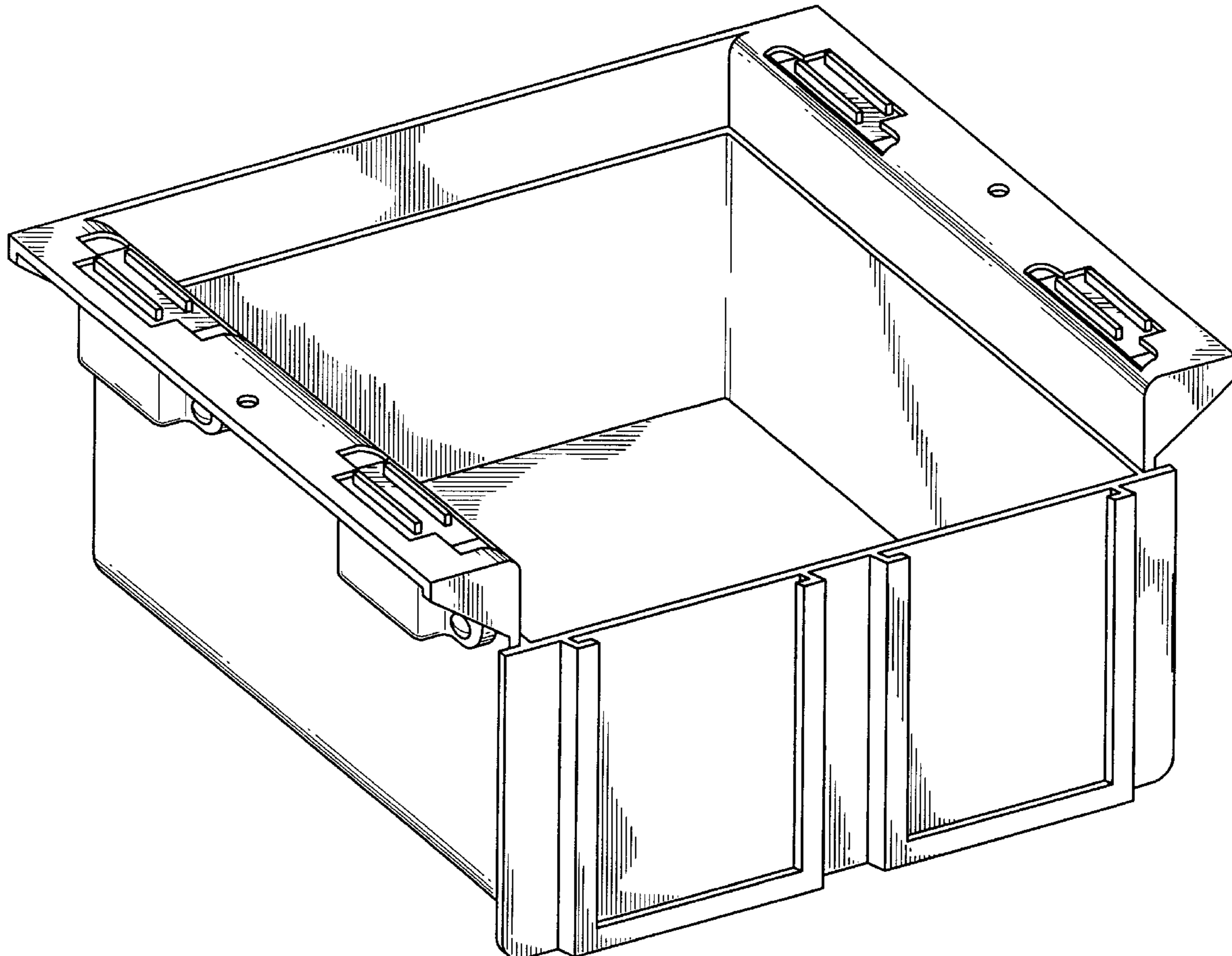
FIG. 1 is a perspective view thereof;  
FIG. 2 is a front elevational view thereof;  
FIG. 3 is a rear elevational view thereof;  
FIG. 4 is a right elevational view thereof;  
FIG. 5 is a top plan view thereof; and,  
FIG. 6 is a bottom plan view thereof.

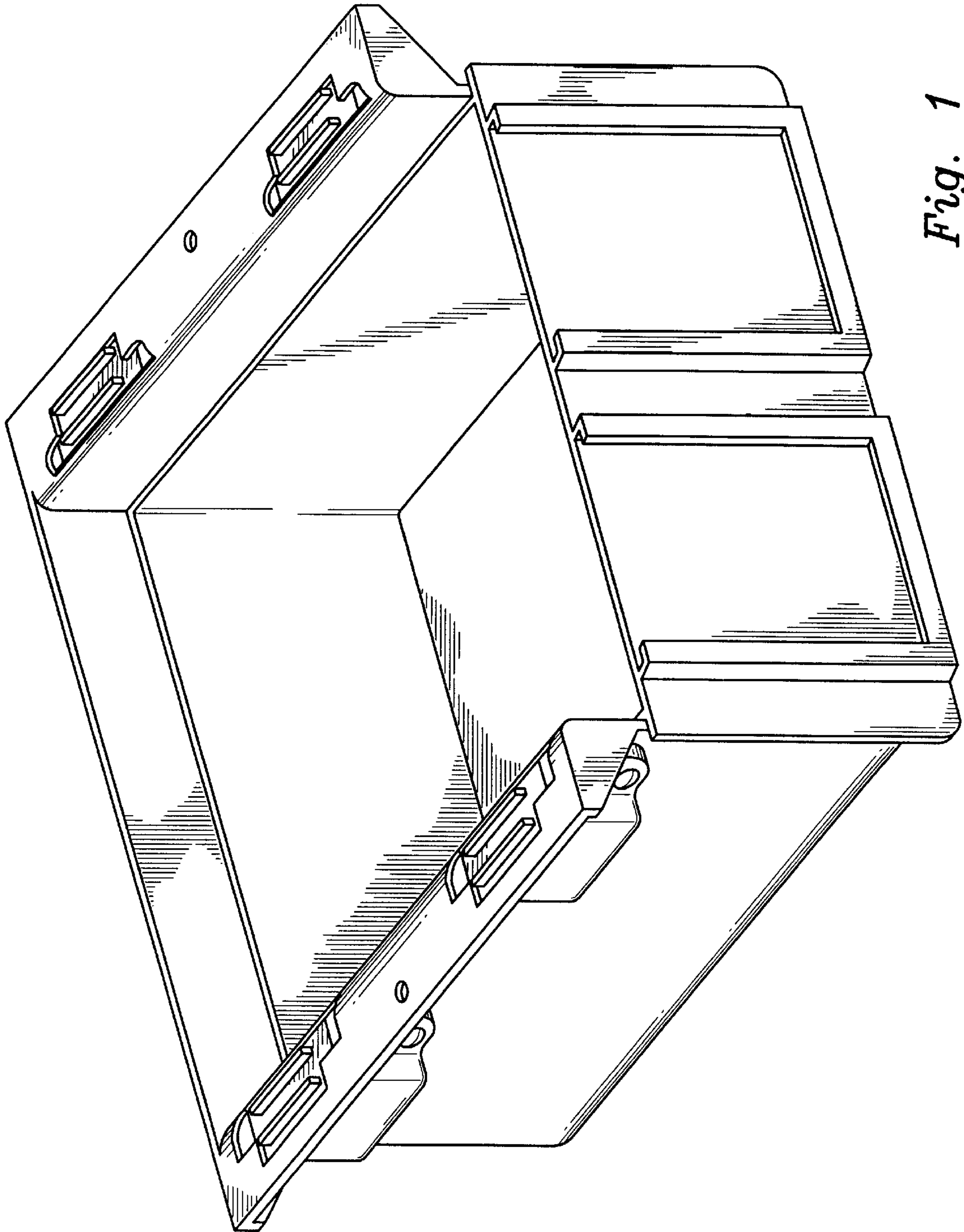
(56) **References Cited**

**U.S. PATENT DOCUMENTS**

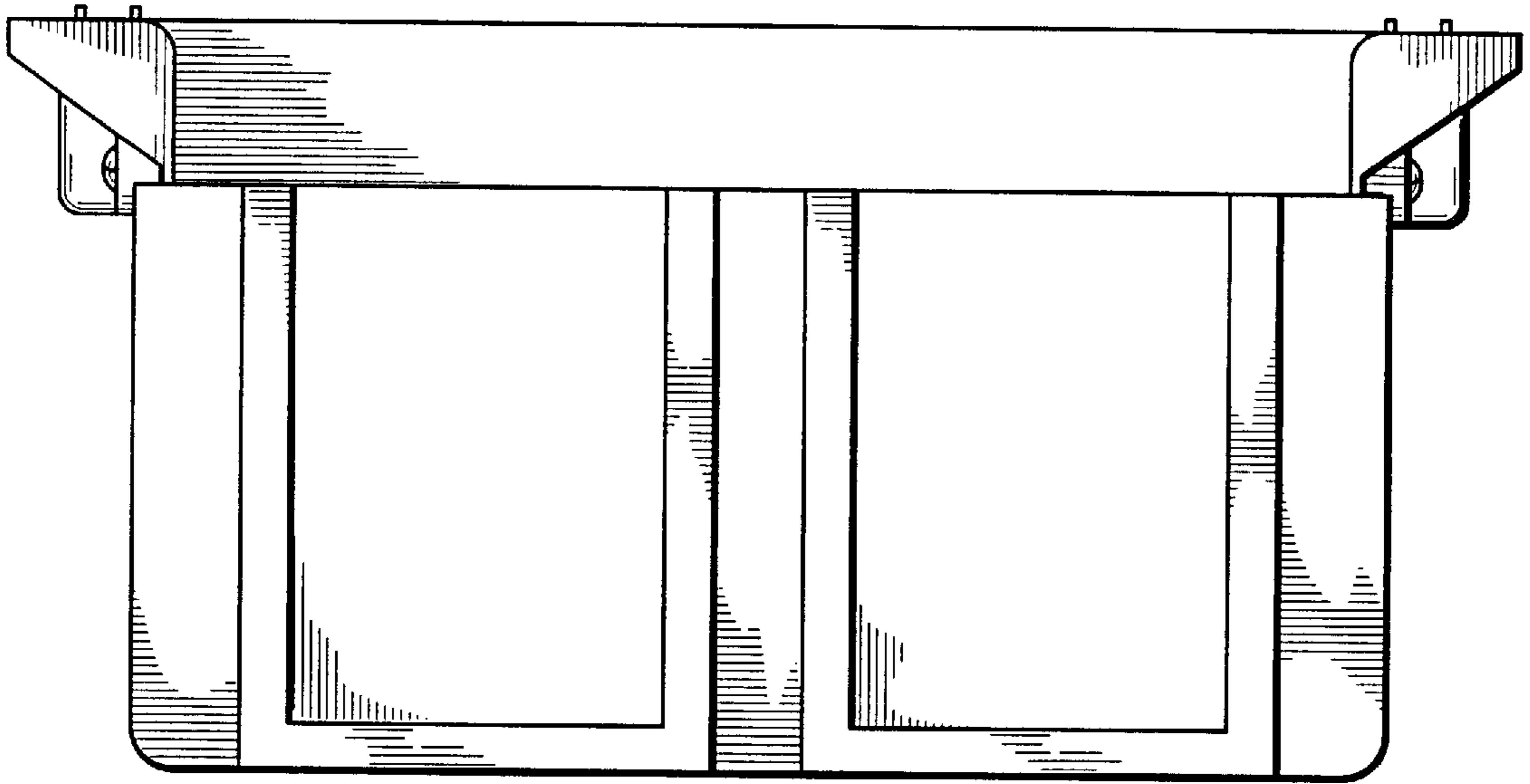
4,318,575 A \* 3/1982 Redlich ..... 312/249.2  
D278,664 S \* 5/1985 Ferdinand et al. .... D6/510  
4,808,875 A \* 2/1989 Edwards ..... 312/245

**1 Claim, 4 Drawing Sheets**

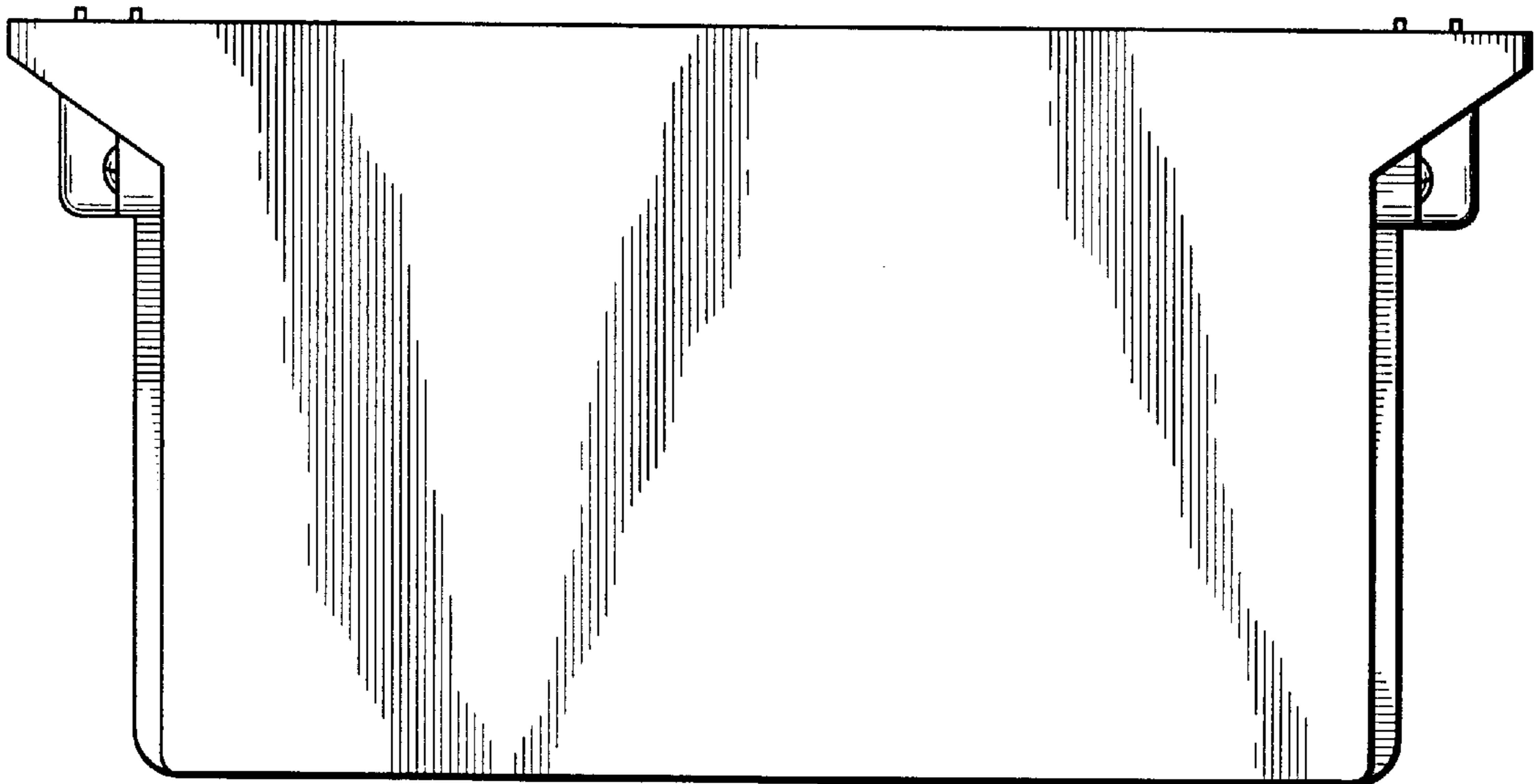




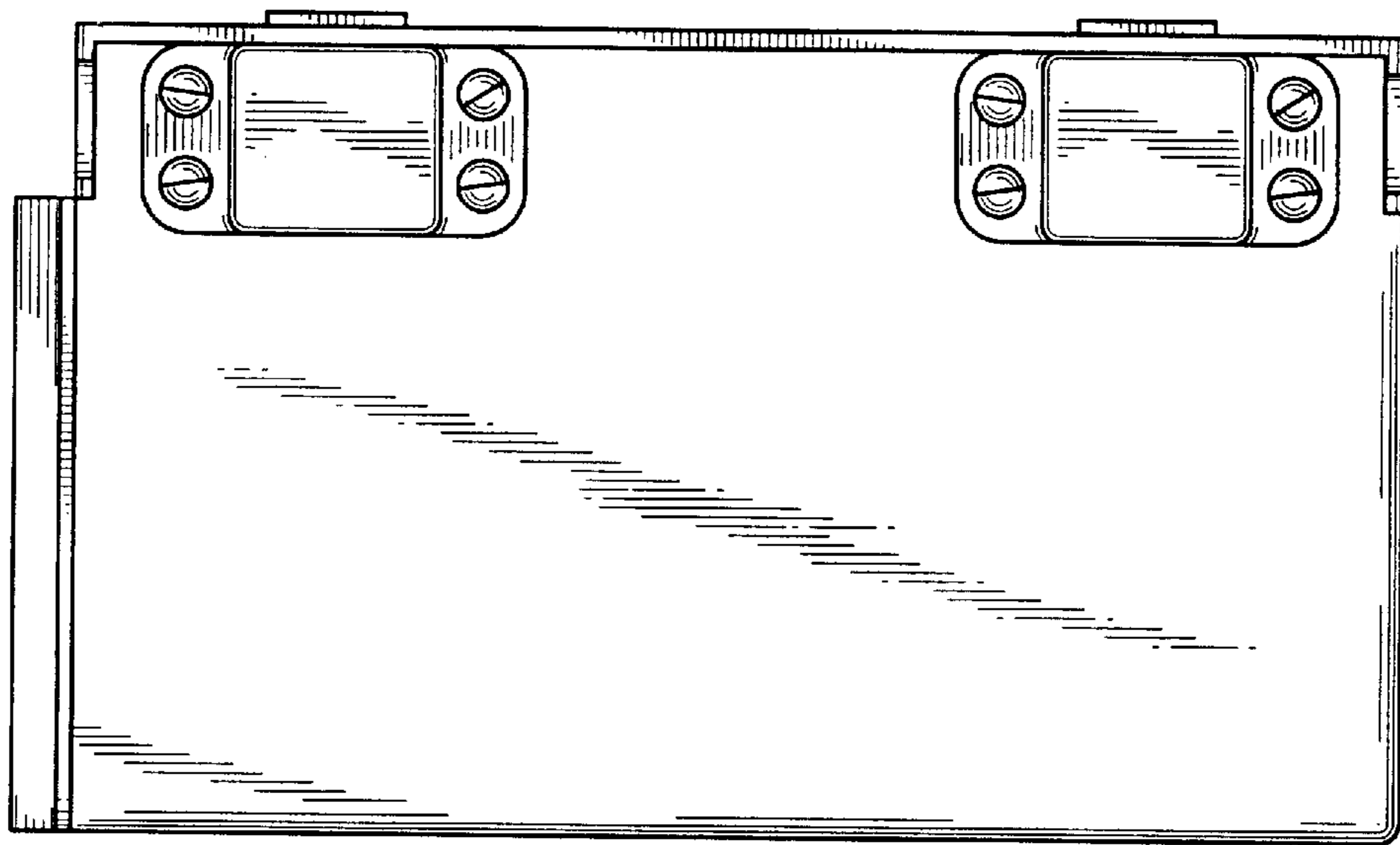
*Fig. 1*



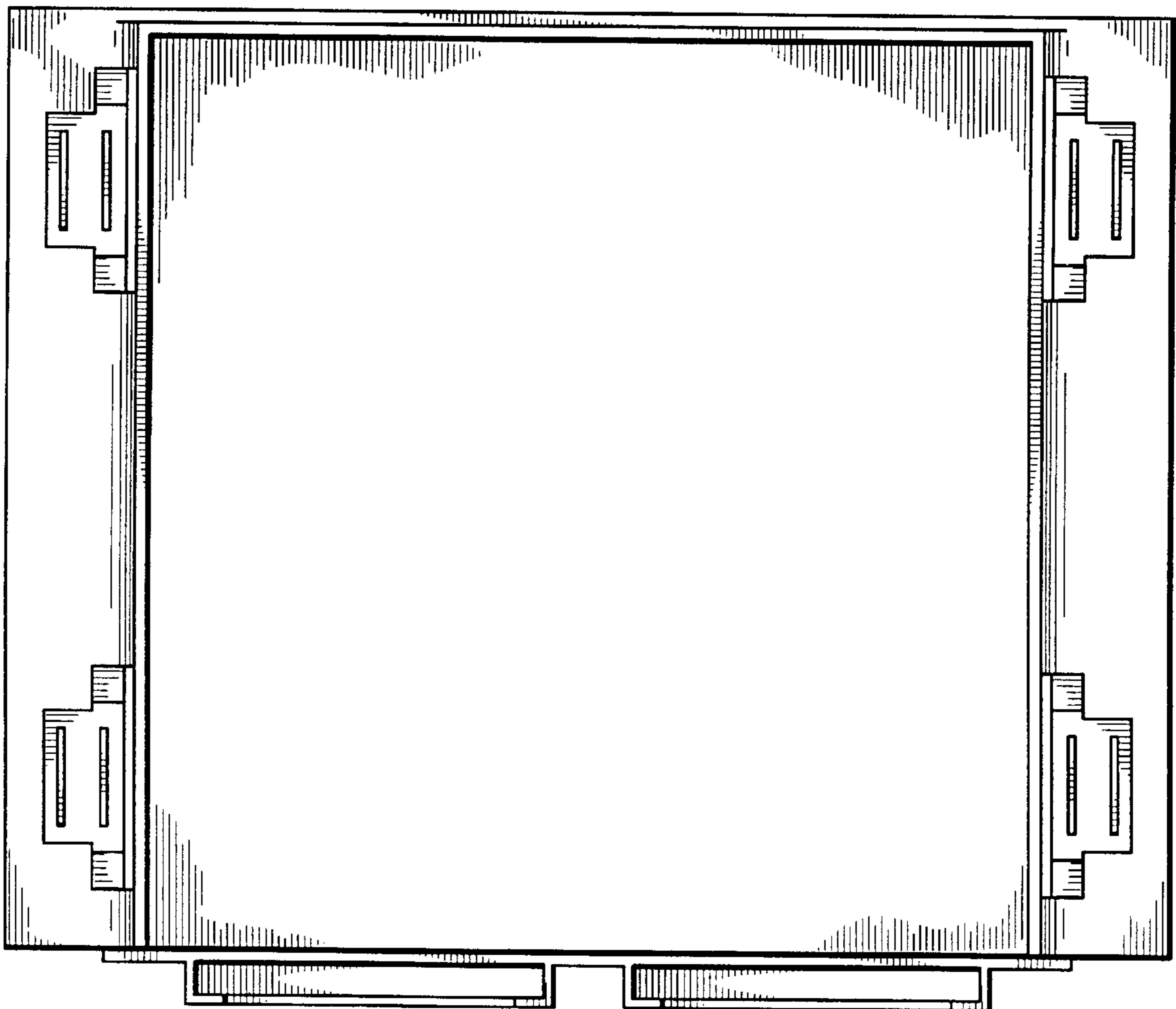
*Fig. 2*



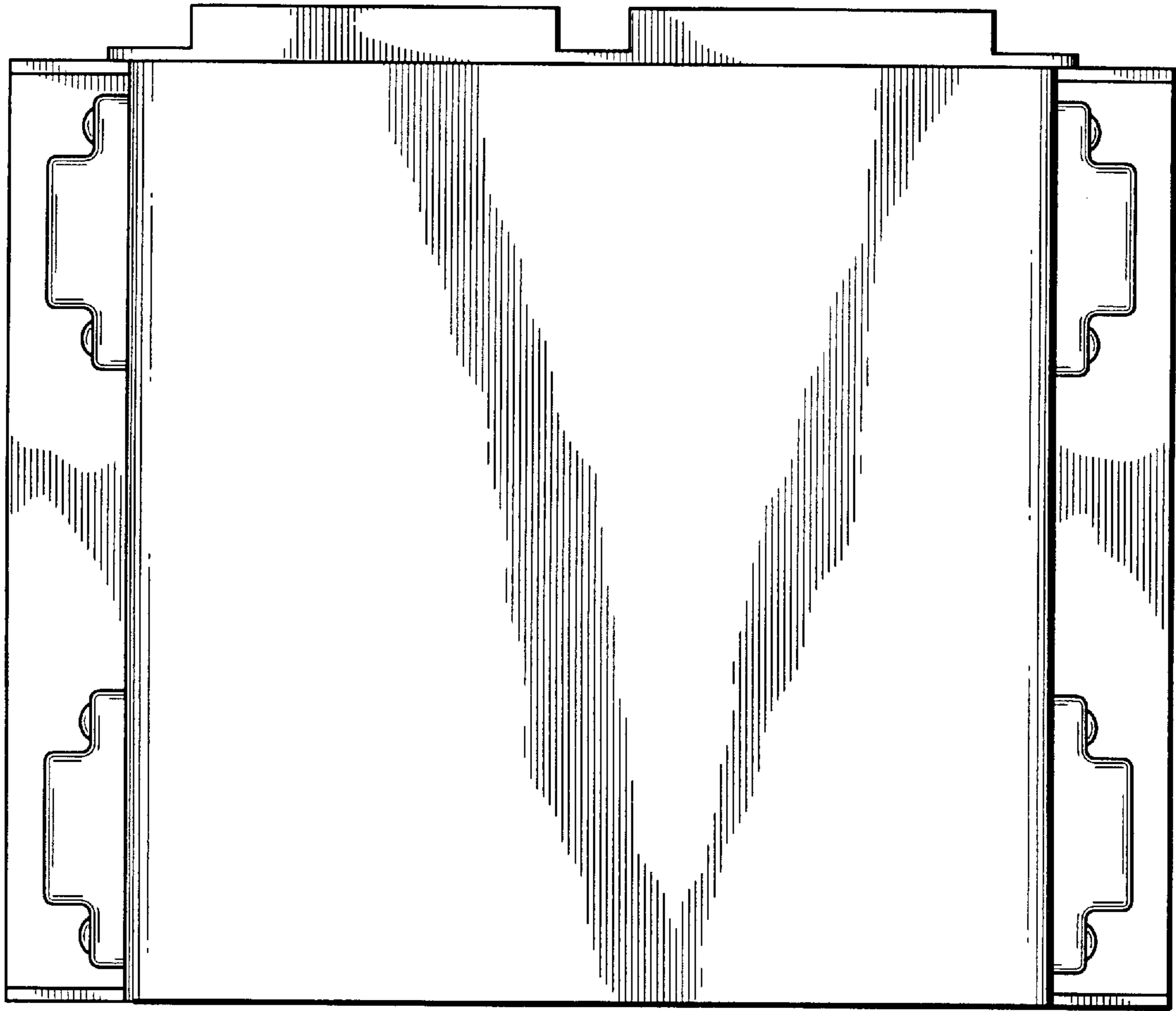
*Fig. 3*



*Fig. 4*



*Fig. 5*



*Fig. 6*