



US00D475815S

(12) **United States Design Patent**  
**Kalhok**

(10) **Patent No.:** **US D475,815 S**

(45) **Date of Patent:** **\*\* Jun. 10, 2003**

(54) **FULL-FACE HELMET**

(75) Inventor: **David Kalhok**, Marion, IL (US)

(73) Assignee: **Bombardier Inc.**, Montreal (CA)

(\*\*) Term: **14 Years**

(21) Appl. No.: **29/149,046**

(22) Filed: **Sep. 28, 2001**

**Related U.S. Application Data**

(62) Division of application No. 29/099,598, filed on Jan. 25, 1999, now Pat. No. Des. 450,160.

(30) **Foreign Application Priority Data**

Dec. 22, 1998 (CA) ..... 1998-3127

(51) **LOC (7) Cl.** ..... **29-02**

(52) **U.S. Cl.** ..... **D29/107**

(58) **Field of Search** ..... D29/102-107,  
D29/122; 2/414, 418, 423, 425, 9, 455

(56) **References Cited**

**U.S. PATENT DOCUMENTS**

1,706,602 A	3/1929	Drager
2,317,608 A	4/1943	Heidbrink
2,348,277 A	5/1944	Boothby et al.
2,867,812 A	1/1959	Roth et al.
3,065,747 A	11/1962	Forkel
3,110,034 A	11/1963	Aileo
3,237,202 A	3/1966	Aileo
3,239,843 A	3/1966	Lobelle
3,310,811 A	3/1967	Iacono, Jr.
3,400,407 A	9/1968	Aileo
3,721,994 A	3/1973	DeSimone et al.
3,768,100 A	10/1973	Colman et al.
3,833,935 A	9/1974	Ansite et al.

(List continued on next page.)

**FOREIGN PATENT DOCUMENTS**

DE	28 46 636	4/1980
DE	44 16 921	11/1995

EP	0371858	6/1990
EP	0 590 255	4/1994
EP	0 638 253	2/1995
GB	2 052 244	1/1981

**OTHER PUBLICATIONS**

Office Action for Canadian Patent Appln. No. 2,354,131, dated Sep. 6, 2001.

*Primary Examiner*—Ruth McInroy

(74) *Attorney, Agent, or Firm*—Pillsbury Winthrop LLP

(57) **CLAIM**

I claim the ornamental design for a full-face helmet, as shown and described.

**DESCRIPTION**

FIG. 1 is a frontal perspective view of a full-face helmet showing my new design;

FIG. 2 is a front elevation view of FIG. 1;

FIG. 3 is a top plan view of FIG. 1;

FIG. 4 is a right side elevation view of FIG. 1;

FIG. 5 is a left side elevation view of FIG. 1;

FIG. 6 is a bottom plan view of FIG. 1;

FIG. 7 is a rear elevation view of FIG. 1;

FIG. 8 is a frontal perspective view of a second embodiment thereof;

FIG. 9 is a front elevation view of FIG. 8;

FIG. 10 is a top plan view of FIG. 8;

FIG. 11 is a right side elevation view of FIG. 8;

FIG. 12 is a left side elevation view of FIG. 8;

FIG. 13 is a bottom plan view of FIG. 8;

FIG. 14 is a rear elevation view of FIG. 8;

FIG. 15 is a frontal perspective view of a third embodiment thereof;

FIG. 16 is a front elevation view of FIG. 15;

FIG. 17 is a top plan view of FIG. 15;

FIG. 18 is a right side elevation view of FIG. 15;

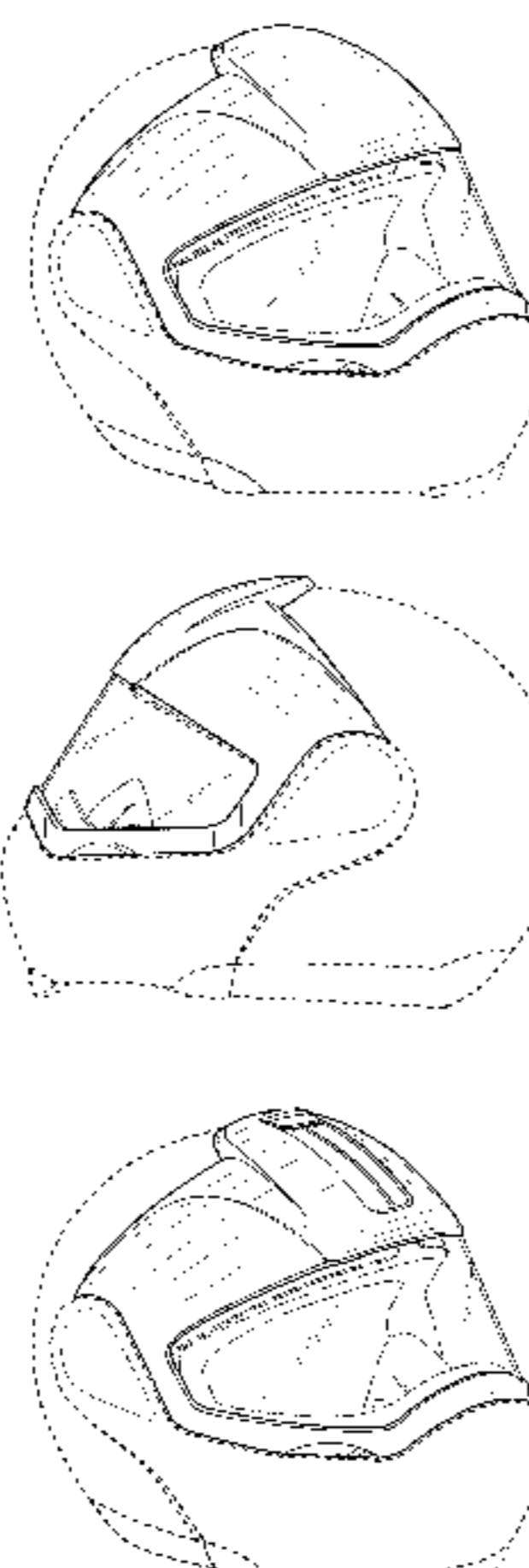
FIG. 19 is a left side elevation view of FIG. 15;

FIG. 20 is a bottom plan view of FIG. 15; and,

FIG. 21 is a rear elevation view of FIG. 15.

Where indicated, dotted lines showing structure form no part of the claimed design.

**1 Claim, 12 Drawing Sheets**



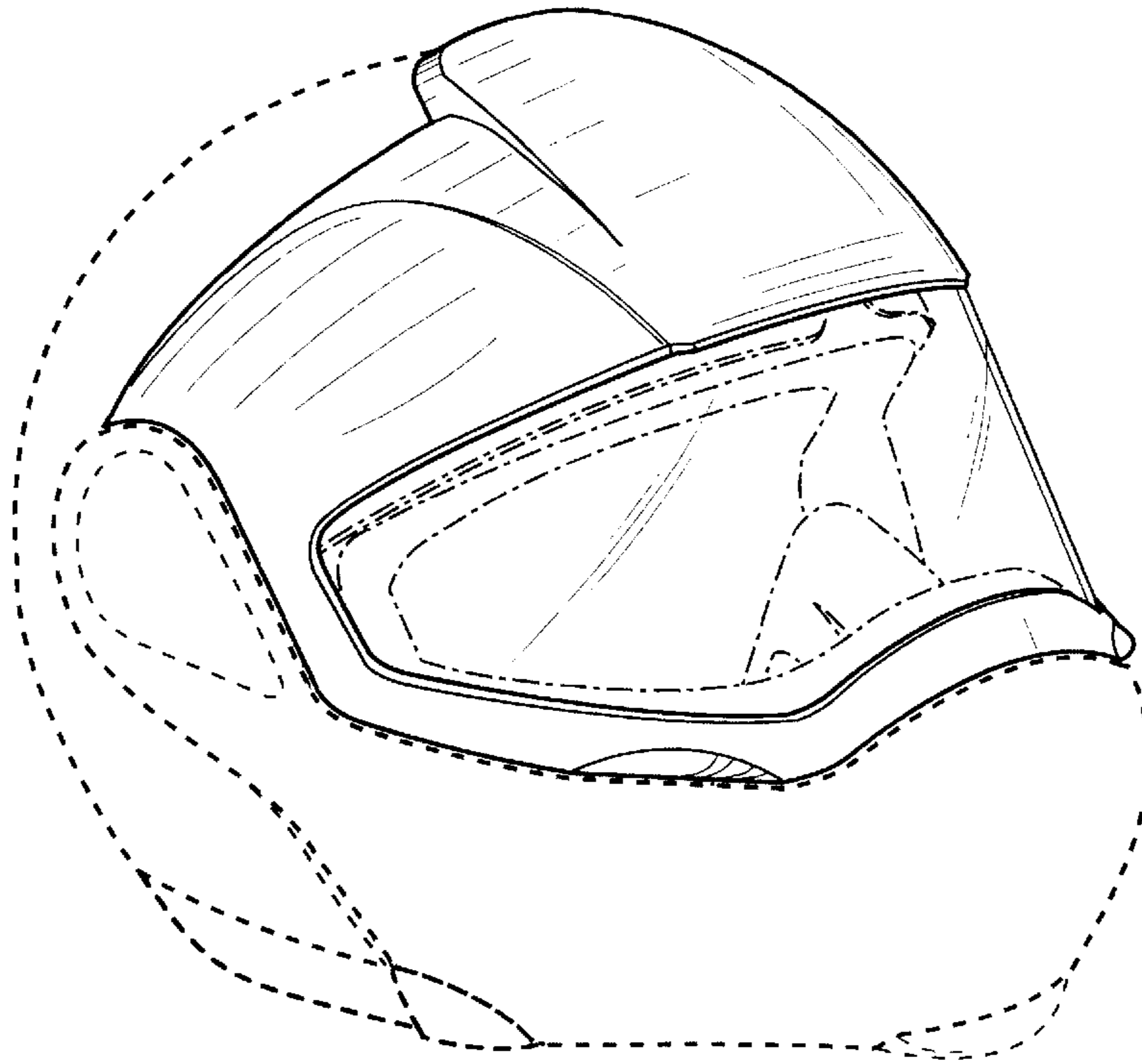
# US D475,815 S

Page 2

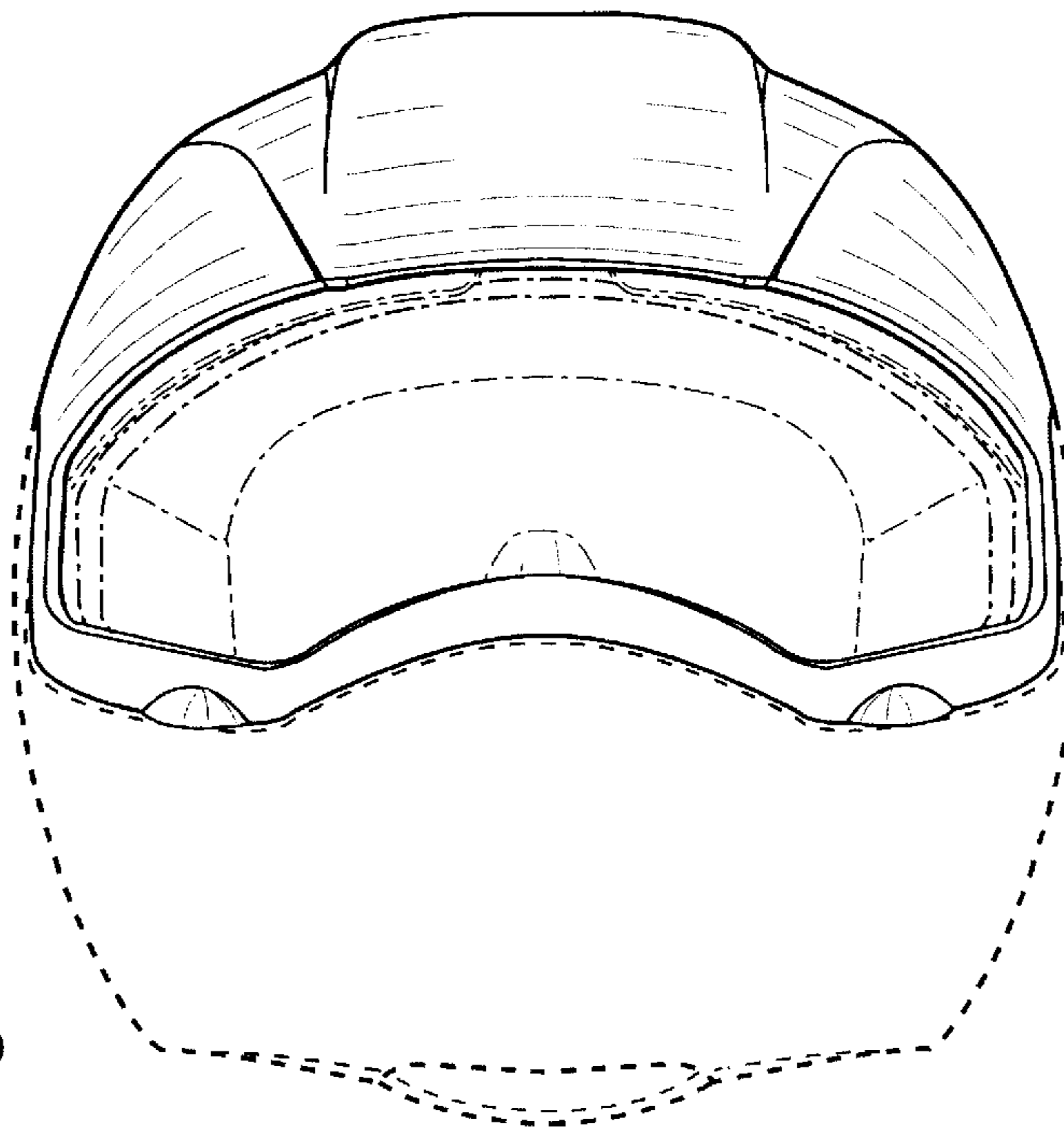
## U.S. PATENT DOCUMENTS

3,971,368 A	7/1976	Forbes et al.	5,396,661 A	3/1995	Sutter et al.
4,170,042 A	10/1979	Aileo	D361,867 S	8/1995	Taniuchi
4,195,328 A	3/1980	Harris, Jr.	5,444,875 A	8/1995	Taniuchi
4,315,335 A	2/1982	Kennedy, Jr. et al.	5,500,953 A	3/1996	Reuber et al.
4,400,591 A	8/1983	Jennings et al.	5,515,843 A	5/1996	Chang
4,555,815 A	12/1985	Walther	5,549,104 A	8/1996	Crump et al.
4,556,994 A	12/1985	Kawasaki et al.	5,555,569 A	9/1996	Lane
4,579,113 A	4/1986	McCreadie et al.	5,584,073 A	12/1996	Radzelovage et al.
4,584,721 A	4/1986	Yamamoto	5,603,317 A	2/1997	Farmer
4,595,003 A	6/1986	Shoemaker et al.	5,619,755 A	4/1997	Casartelli
4,598,430 A	7/1986	Nava	5,630,412 A	5/1997	Dubruille et al.
4,667,348 A	5/1987	Sundahl	5,653,225 A	8/1997	Schegerin
4,676,236 A	6/1987	Piorkowski et al.	5,694,650 A	12/1997	Hong
4,689,836 A	9/1987	Vitaloni	5,722,091 A	3/1998	Keller et al.
4,734,940 A	4/1988	Galet et al.	5,758,639 A	6/1998	Ikonen
4,764,990 A	8/1988	Markert	5,765,235 A	6/1998	Arnold
4,803,980 A	2/1989	Nowakowski et al.	5,794,260 A	8/1998	Schegerin
4,886,056 A	12/1989	Simpson	5,797,146 A	8/1998	Matich
4,907,300 A	3/1990	Dampney et al.	5,910,764 A	6/1999	Hayden
D312,513 S	11/1990	Morin	D411,900 S	7/1999	Puleo
5,003,632 A	4/1991	Claude	5,924,420 A	7/1999	Reischel et al.
5,078,130 A	1/1992	Van Oosten et al.	5,930,843 A	8/1999	Kelly
5,093,939 A	3/1992	Noyerie et al.	D418,255 S	12/1999	Hohdorf
H1039 H	4/1992	Tripp, Jr. et al.	6,047,409 A	4/2000	Simpson
D331,299 S	11/1992	Kamata	6,075,857 A	6/2000	Doss, Jr. et al.
5,187,502 A	2/1993	Howell	6,161,225 A	12/2000	Arai
D334,250 S	3/1993	Gallet	6,249,918 B1	6/2001	Lacroix
D340,545 S	10/1993	Kamata	D446,357 S *	8/2001	Shida ..... D29/107
D340,546 S	10/1993	Kamata	D447,605 S *	9/2001	Kalhok ..... D29/107
5,291,880 A	3/1994	Almovist et al.	D450,160 S *	11/2001	Kalhok ..... D29/107
D351,685 S	10/1994	Kamata	D451,643 S *	12/2001	Kalhok ..... D29/107
5,351,339 A	10/1994	Reuber et al.	D452,592 S *	12/2001	Kalhok ..... D29/107
5,394,566 A	3/1995	Hong			

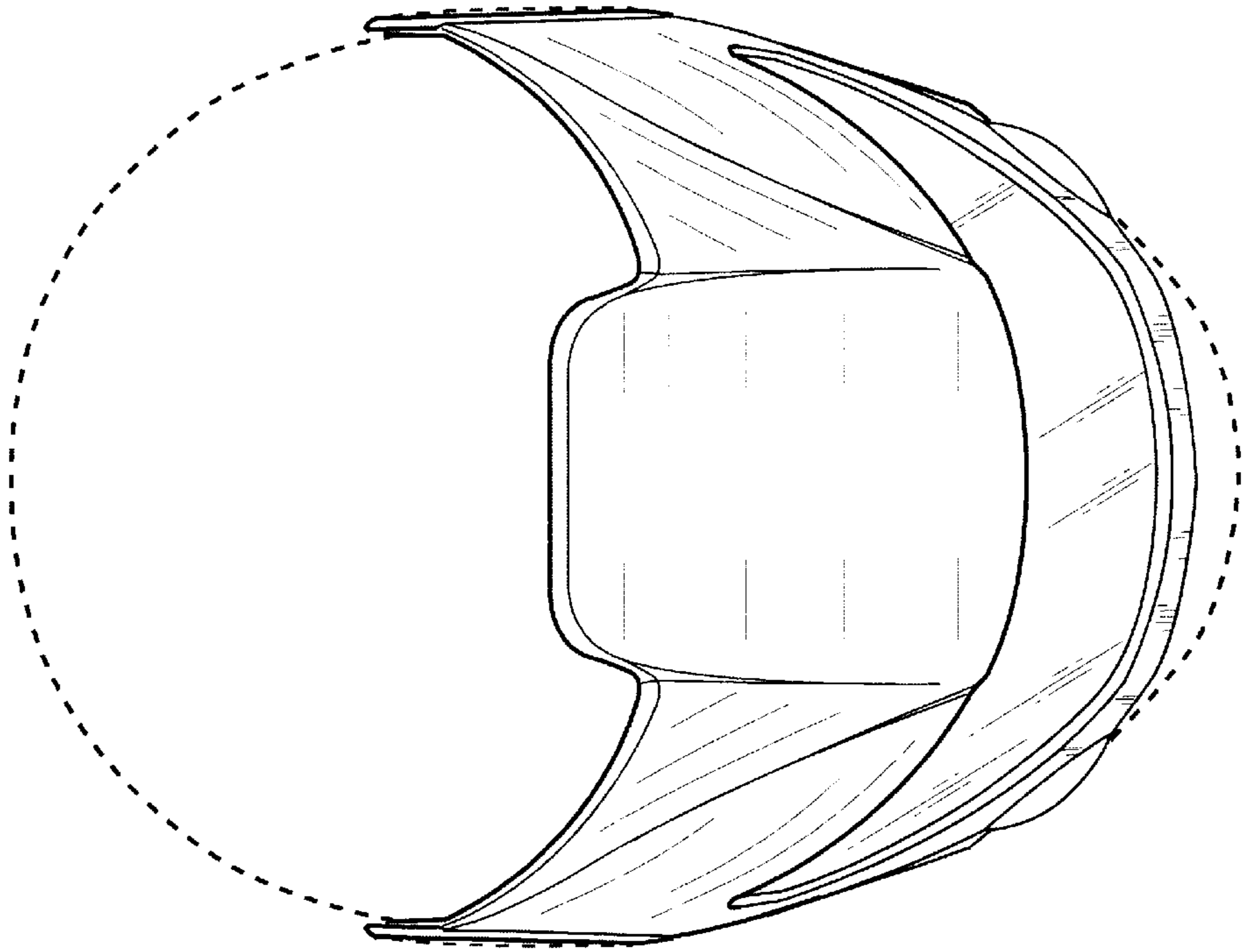
\* cited by examiner



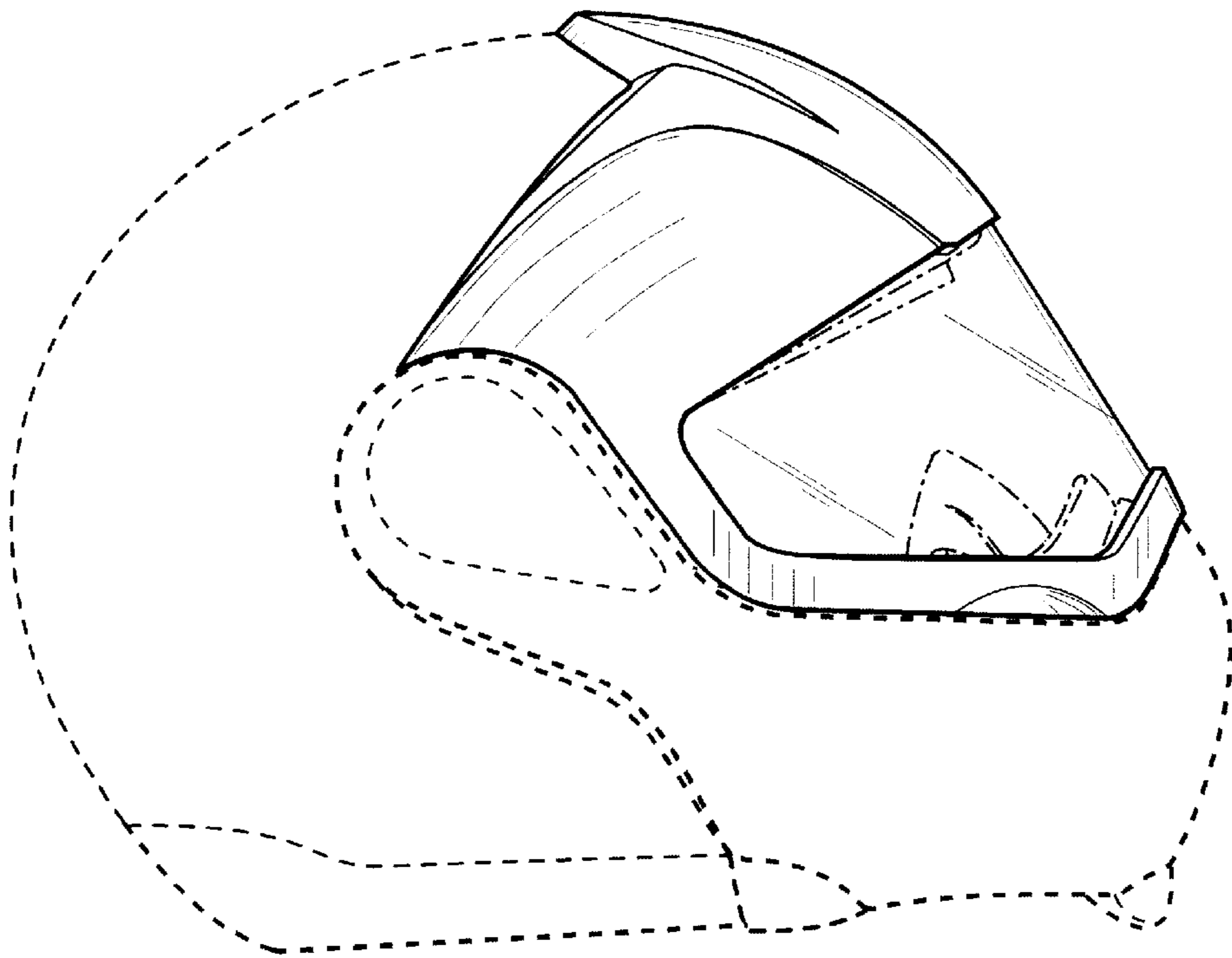
**FIG. 1**



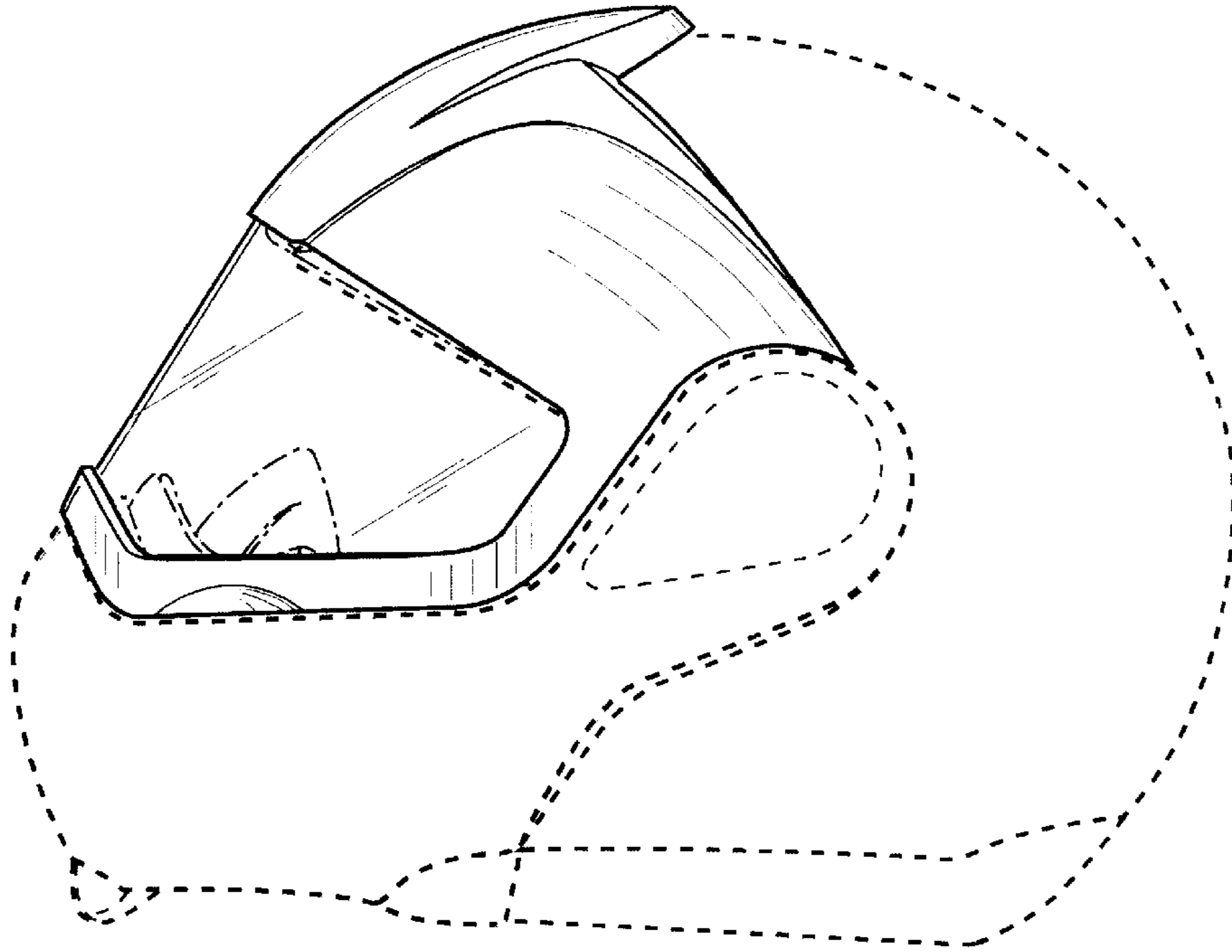
**FIG. 2**



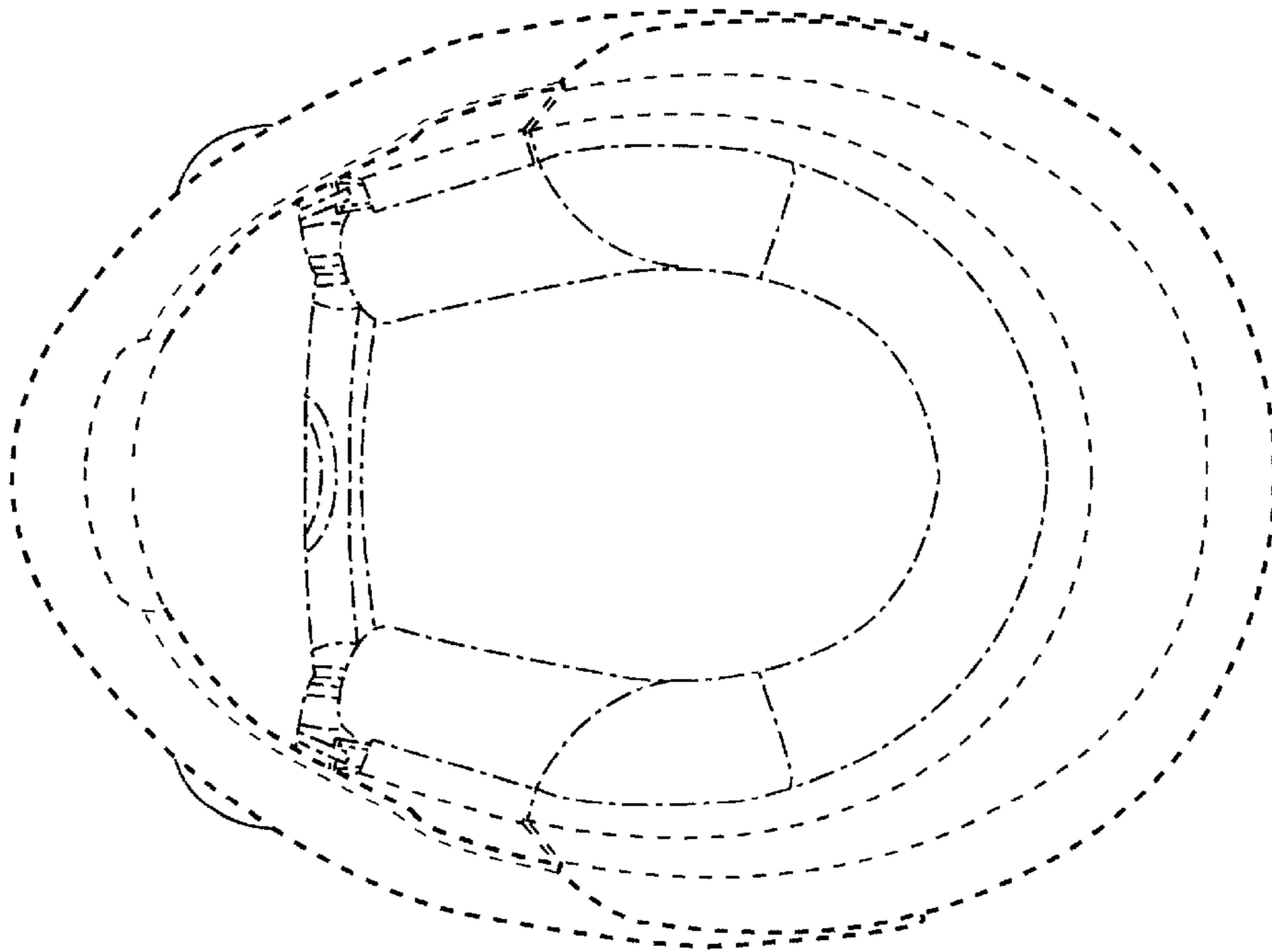
**FIG. 3**



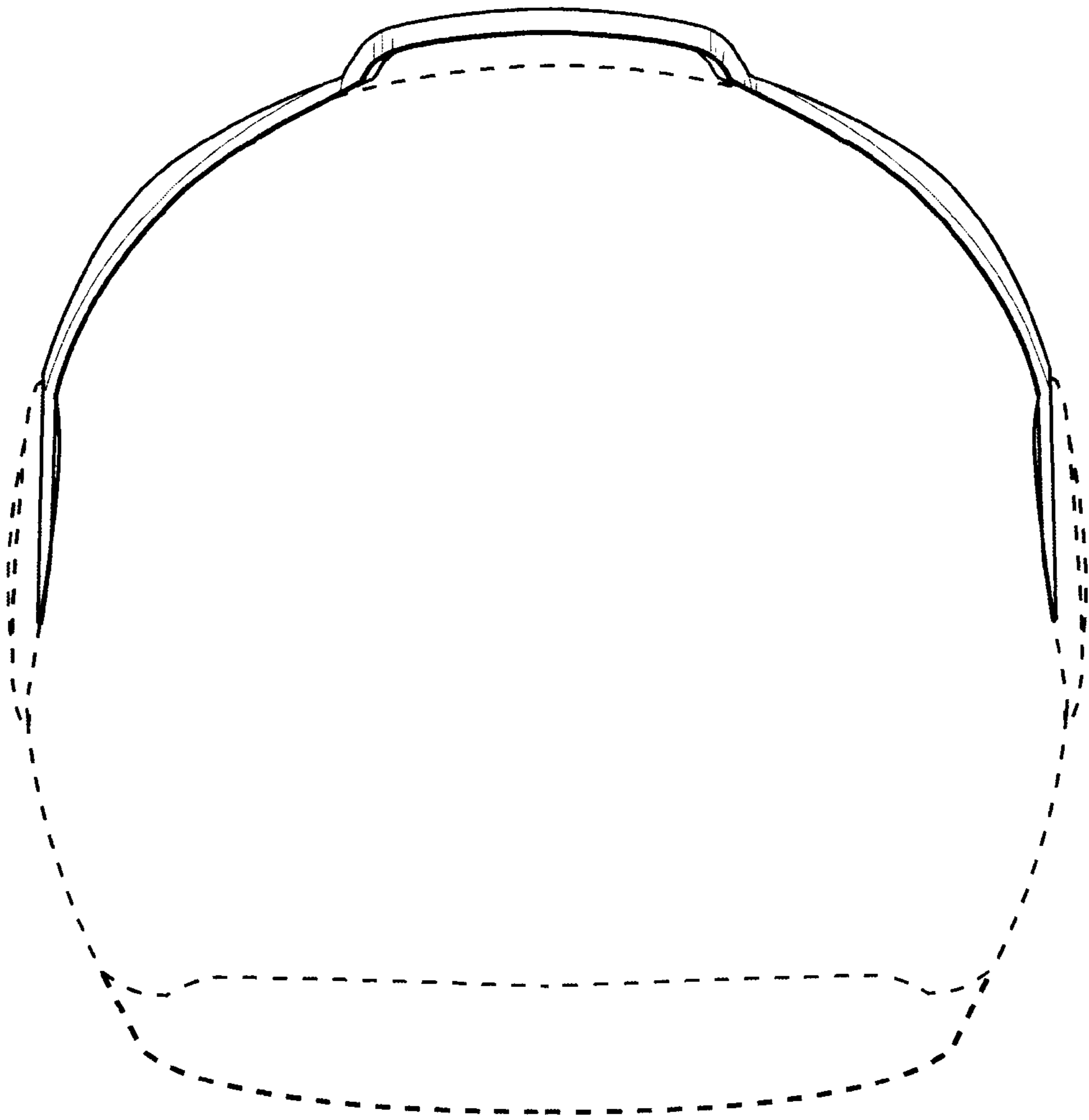
**FIG. 4**



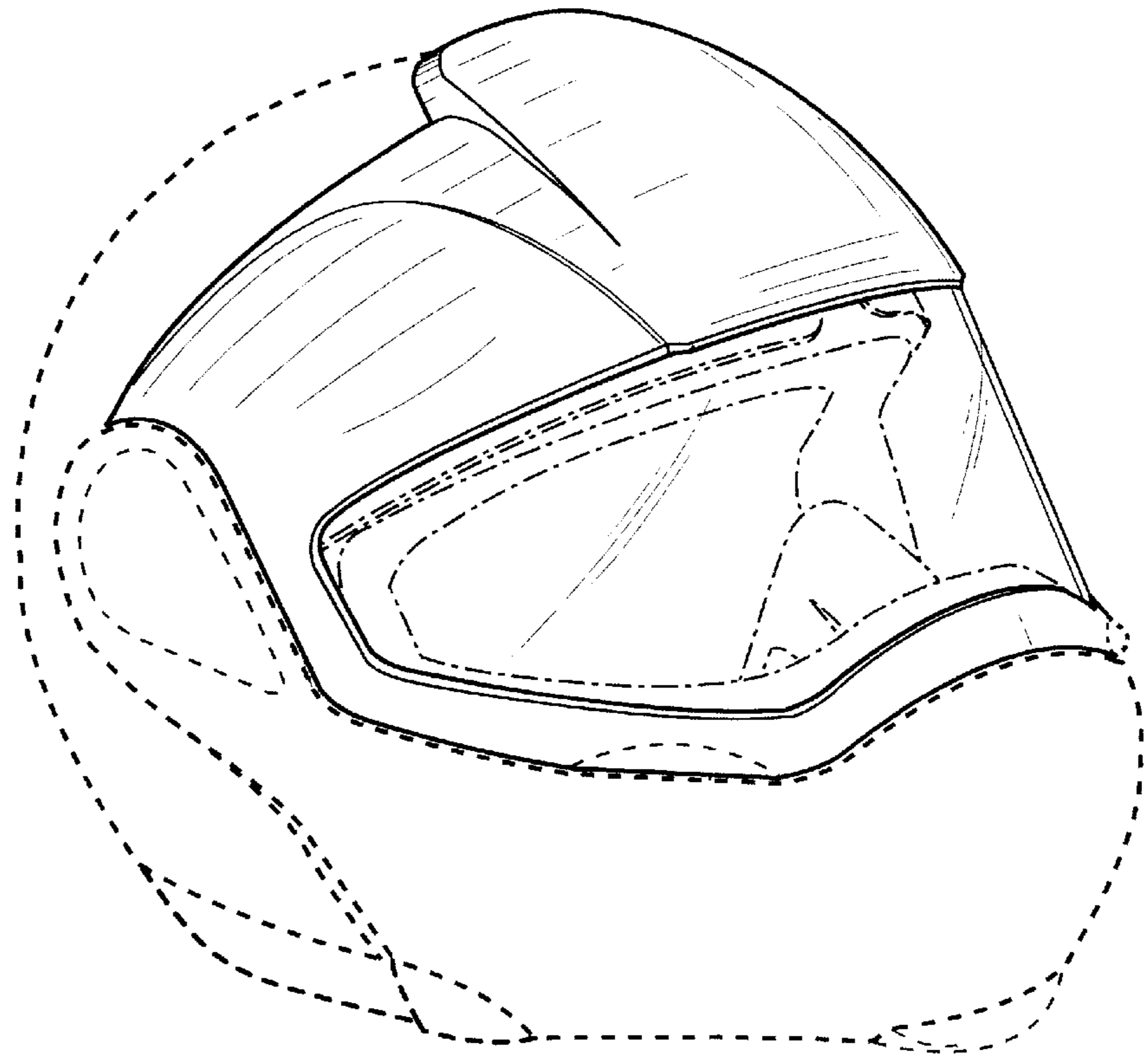
**FIG. 5**



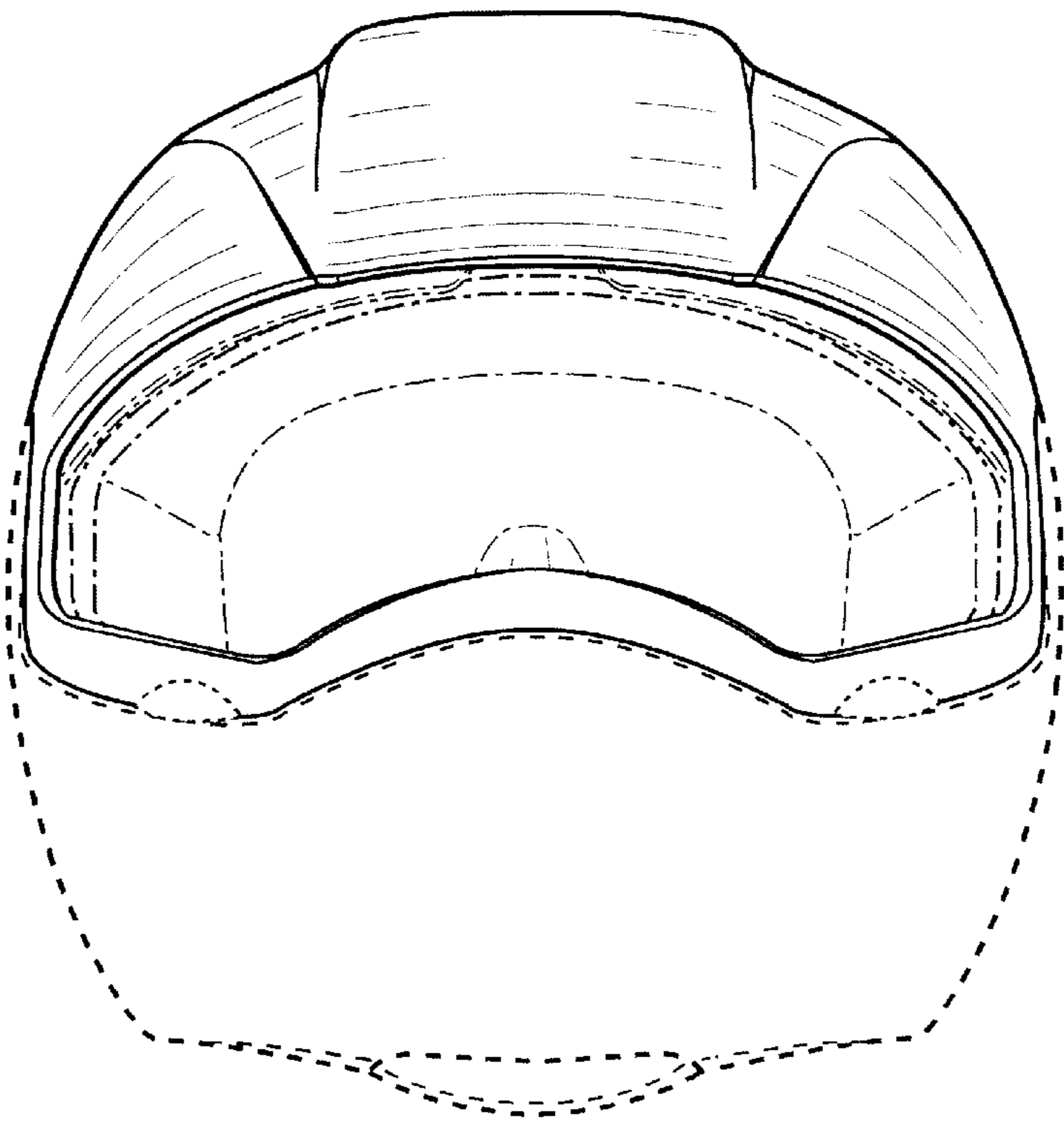
**FIG. 6**



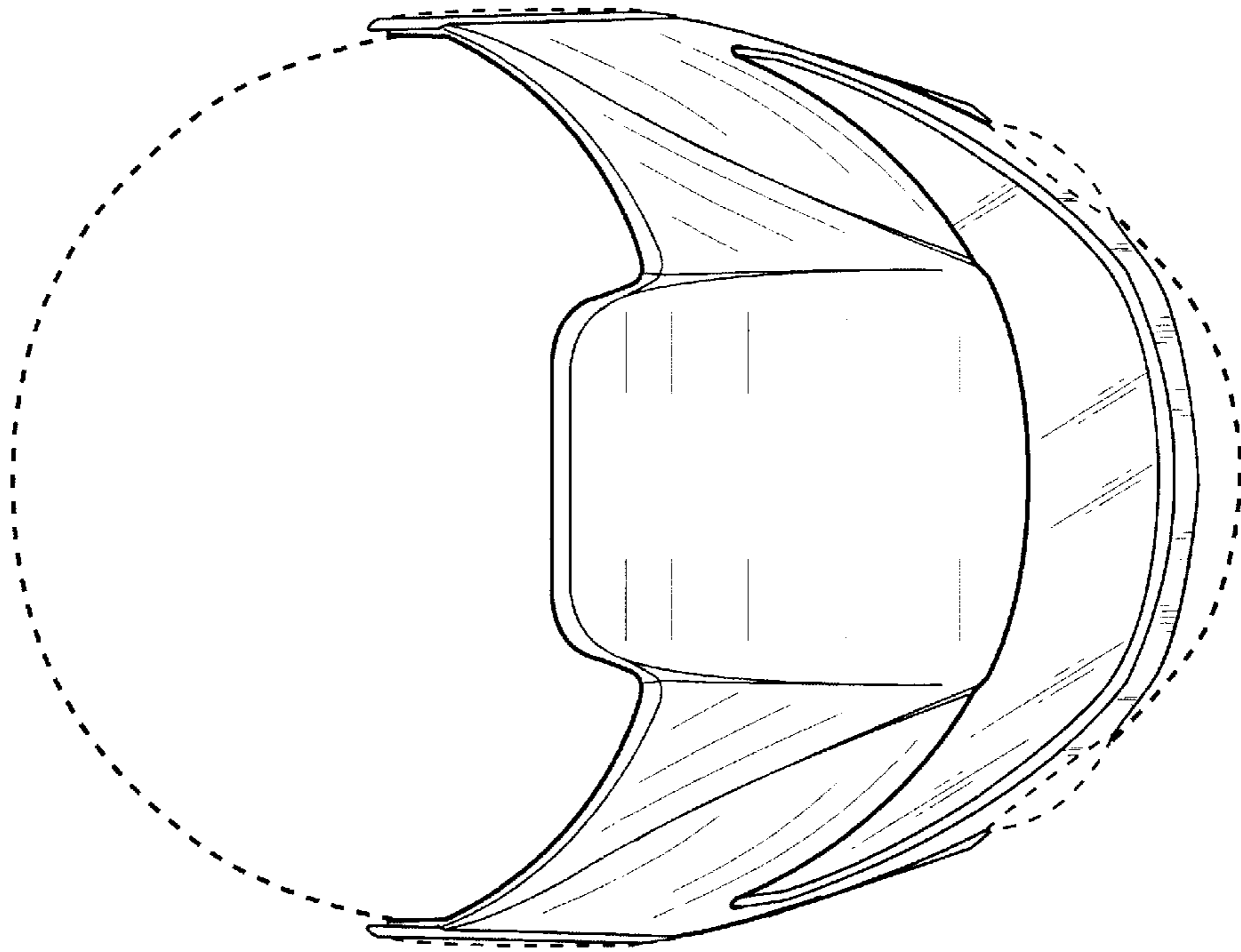
**FIG. 7**



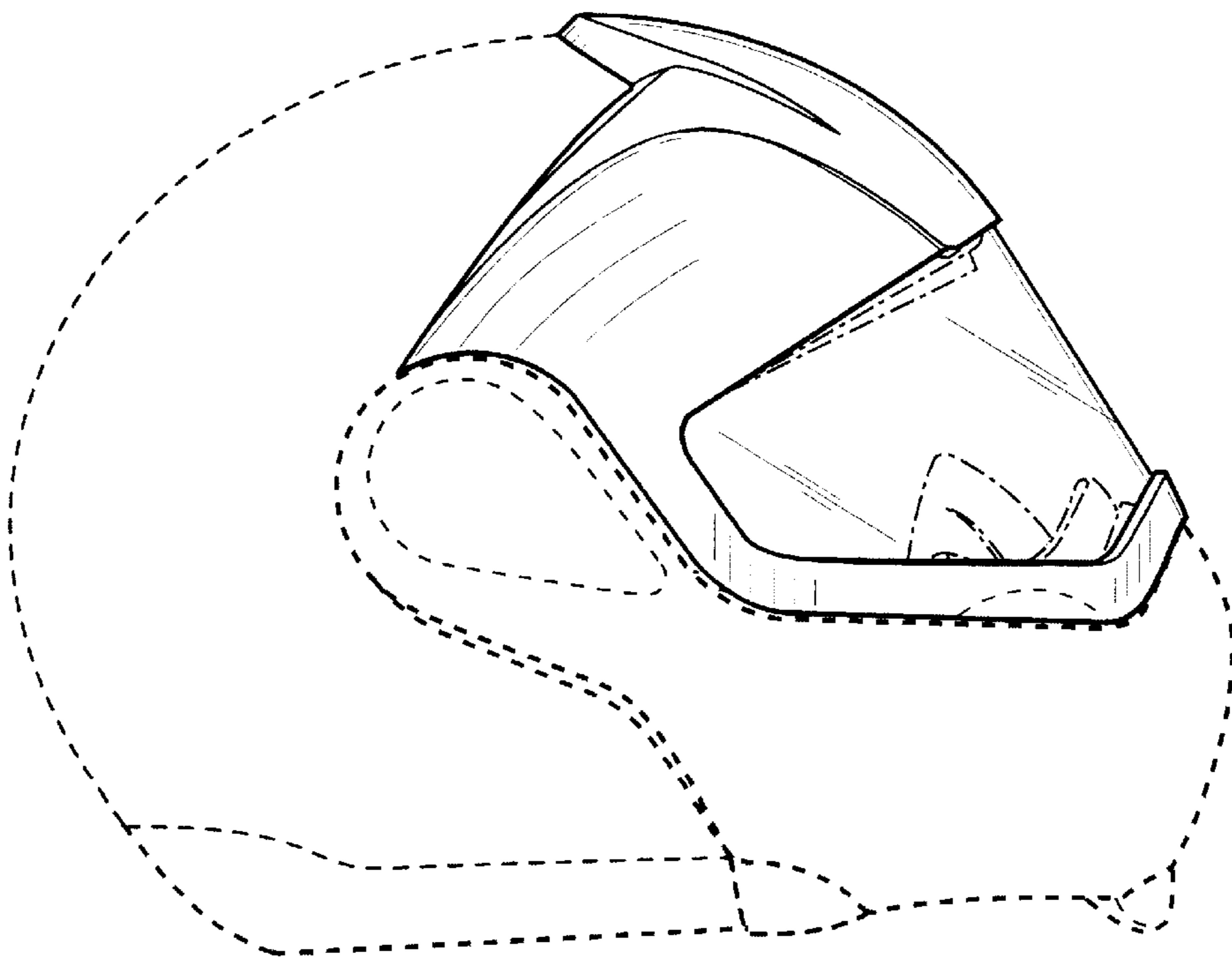
**FIG. 8**



**FIG. 9**

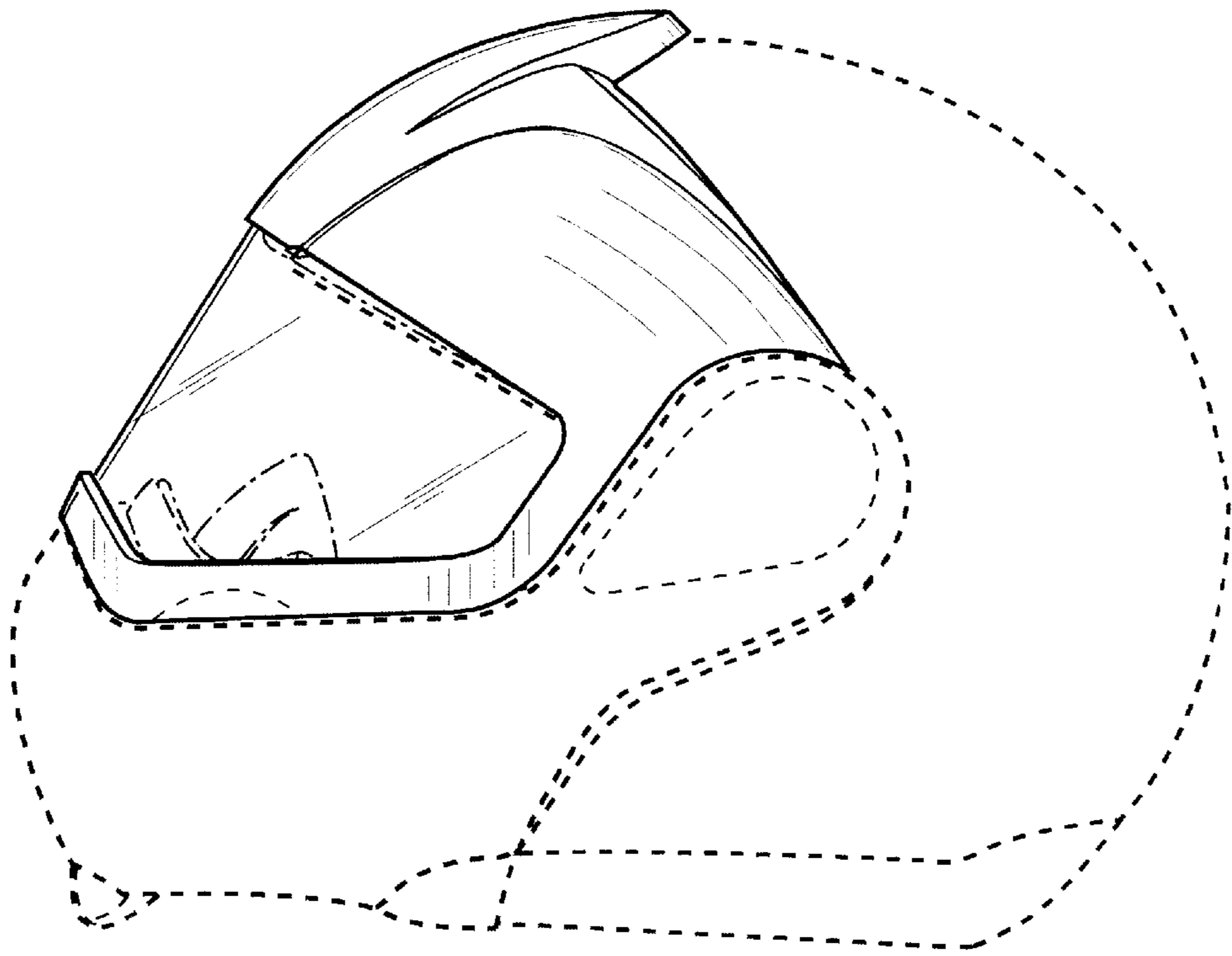


**FIG. 10**

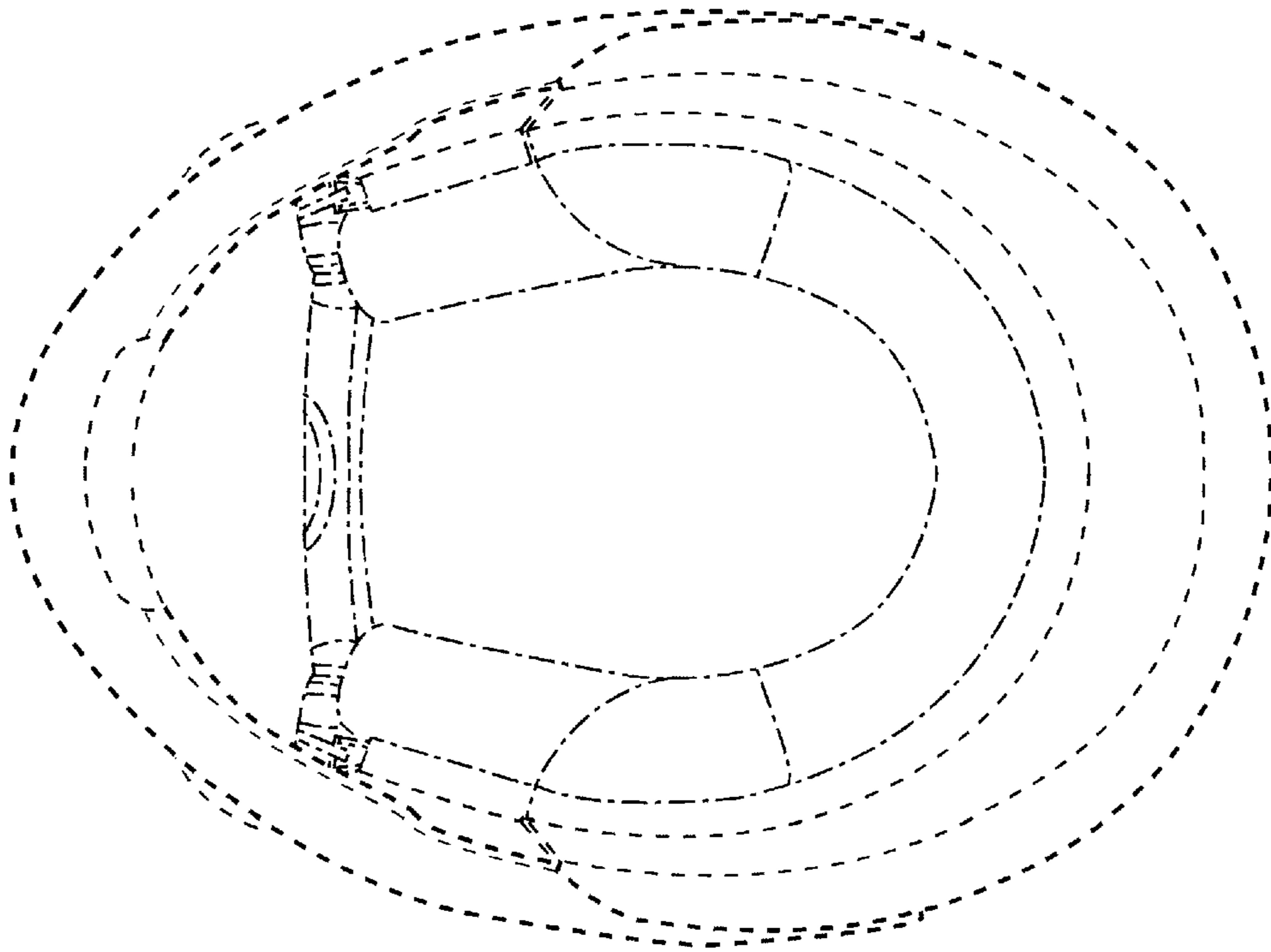


**FIG. 11**

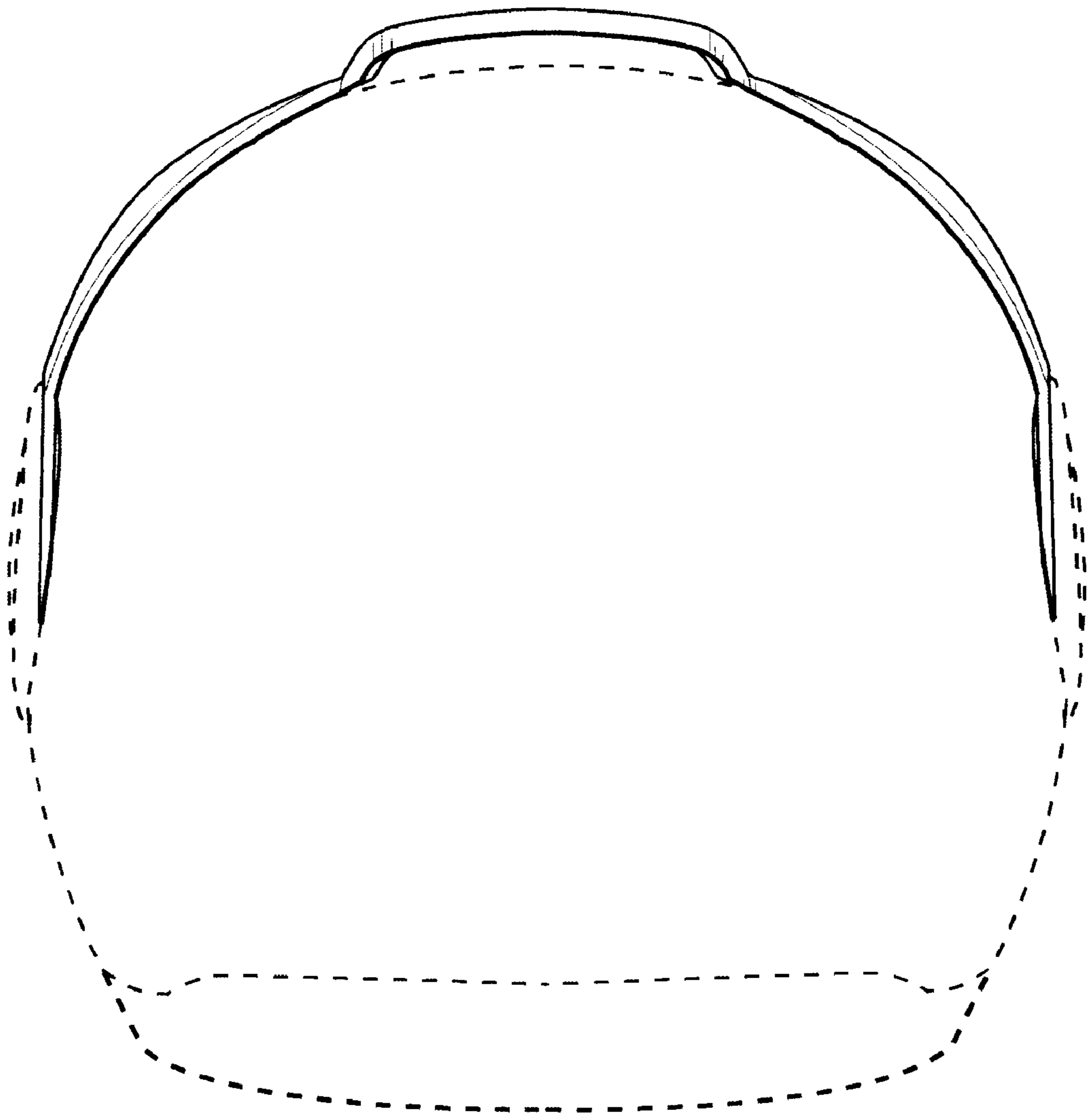




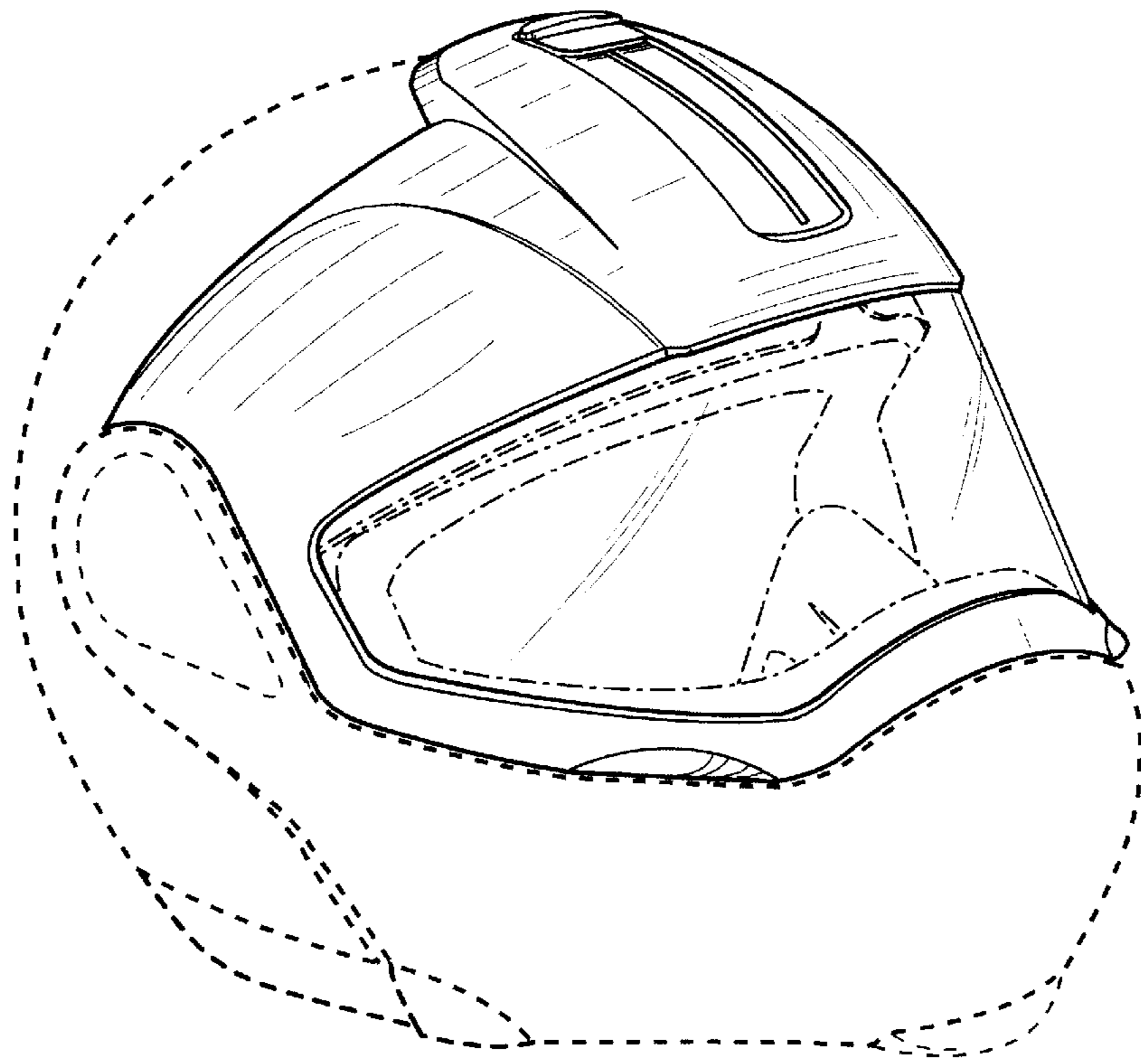
**FIG. 12**



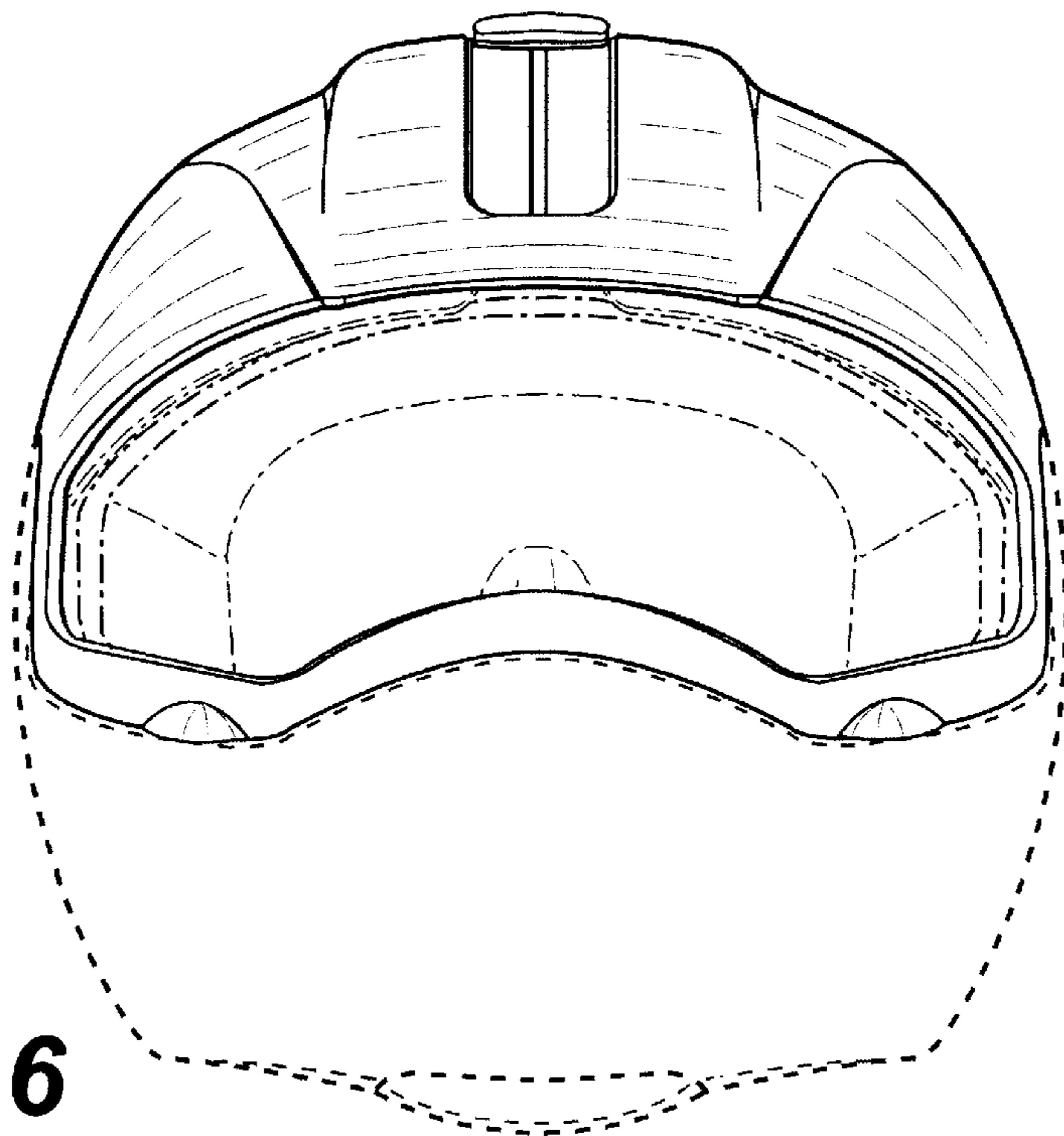
**FIG. 13**



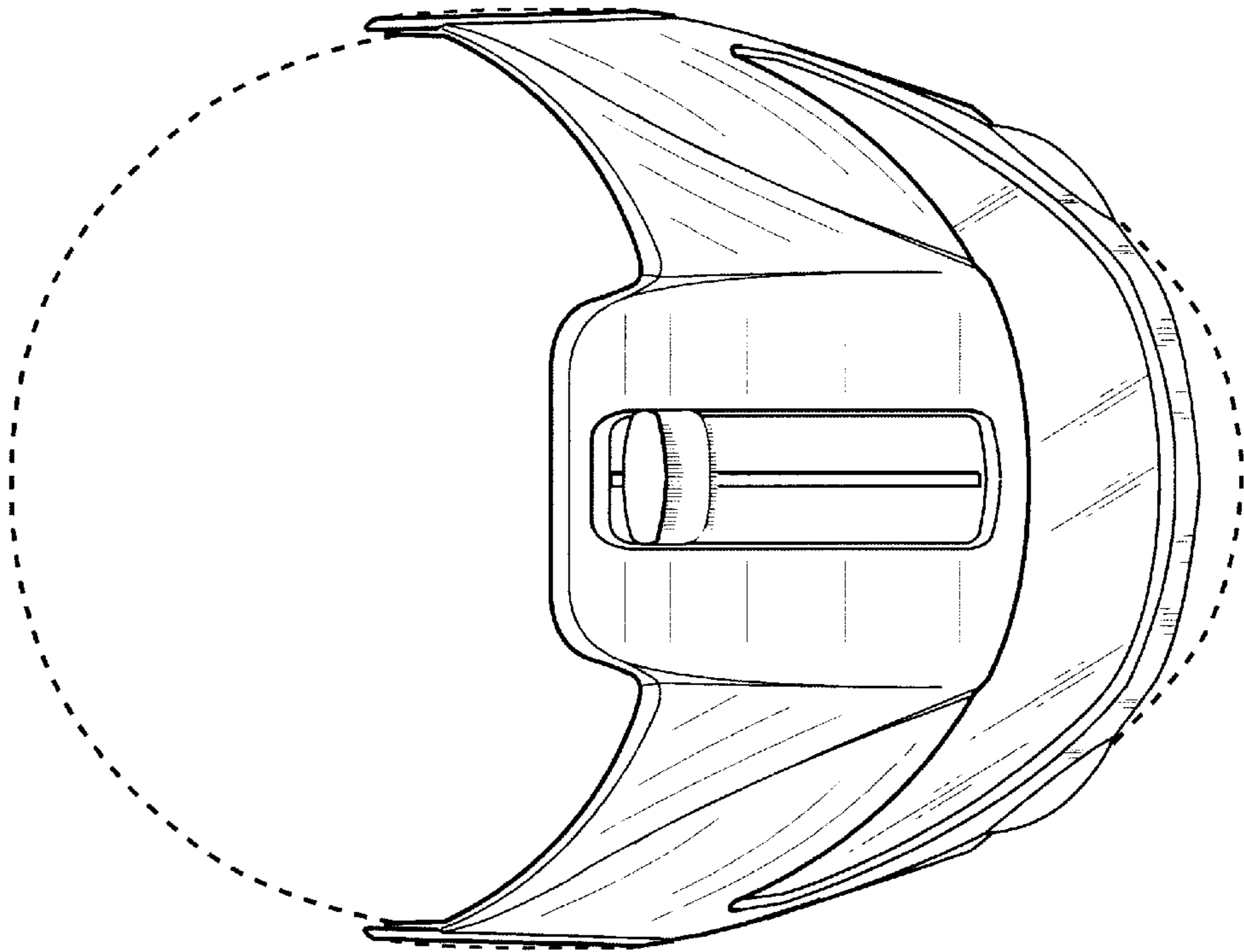
**FIG. 14**



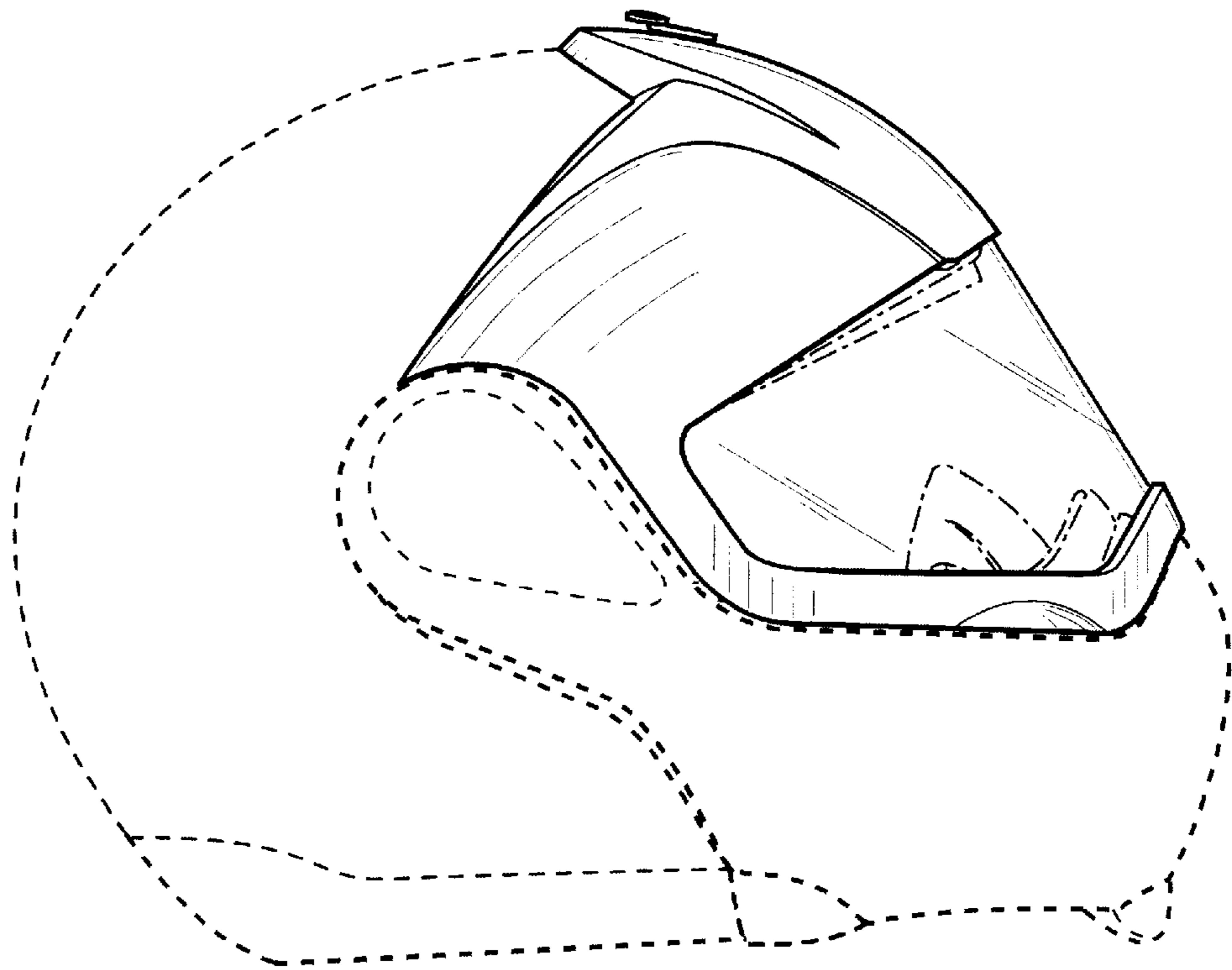
**FIG. 15**



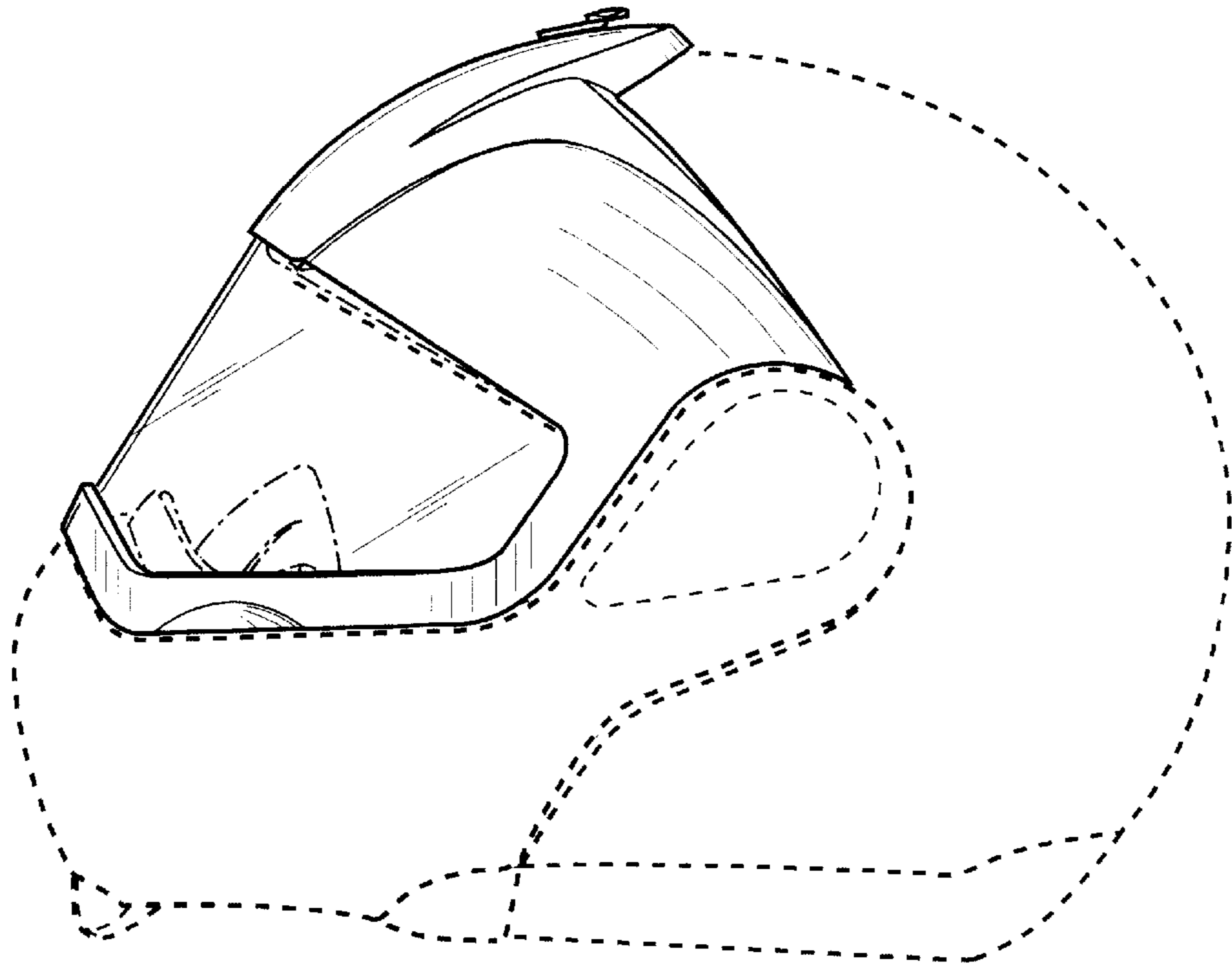
**FIG. 16**



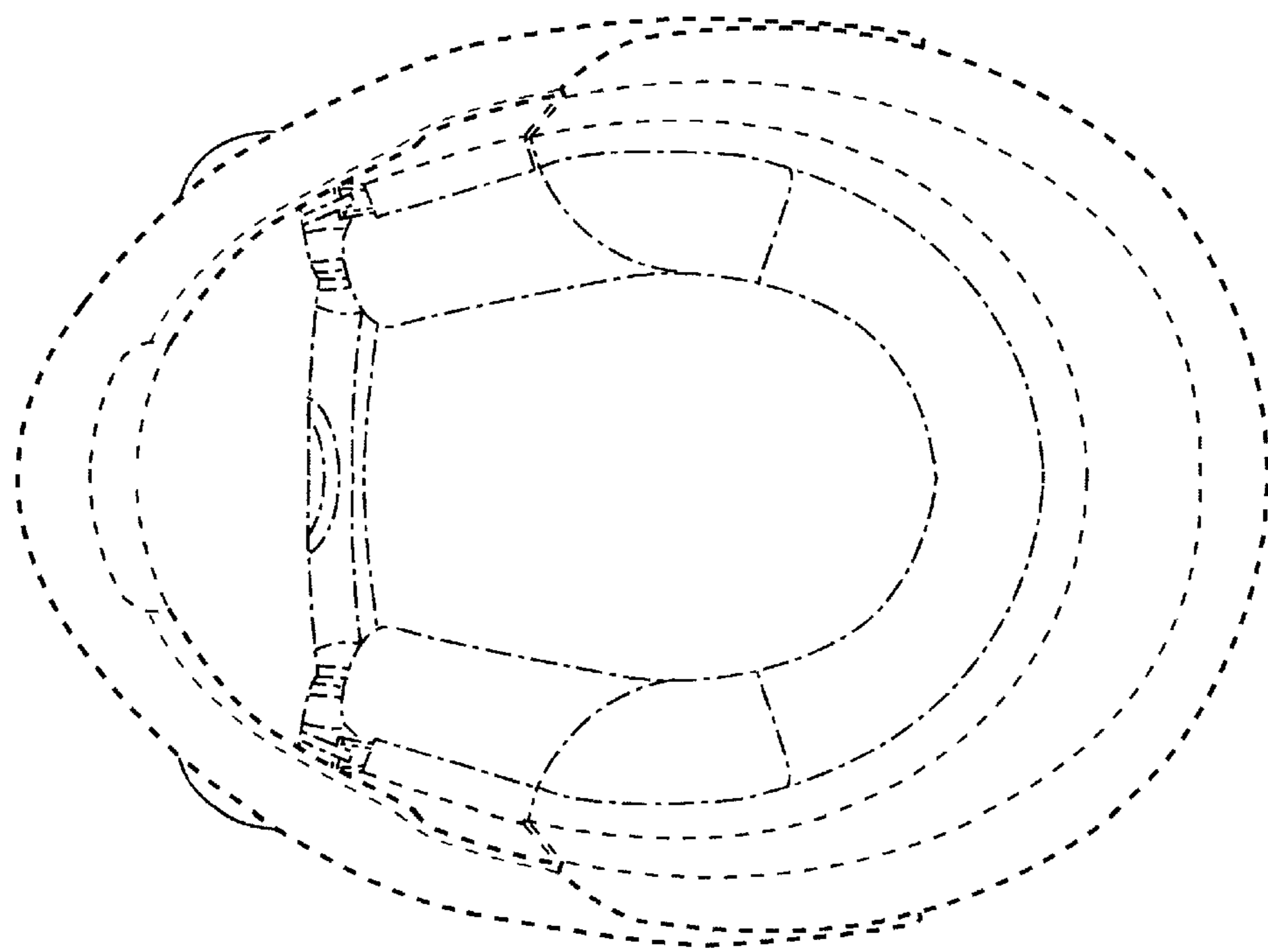
**FIG. 17**



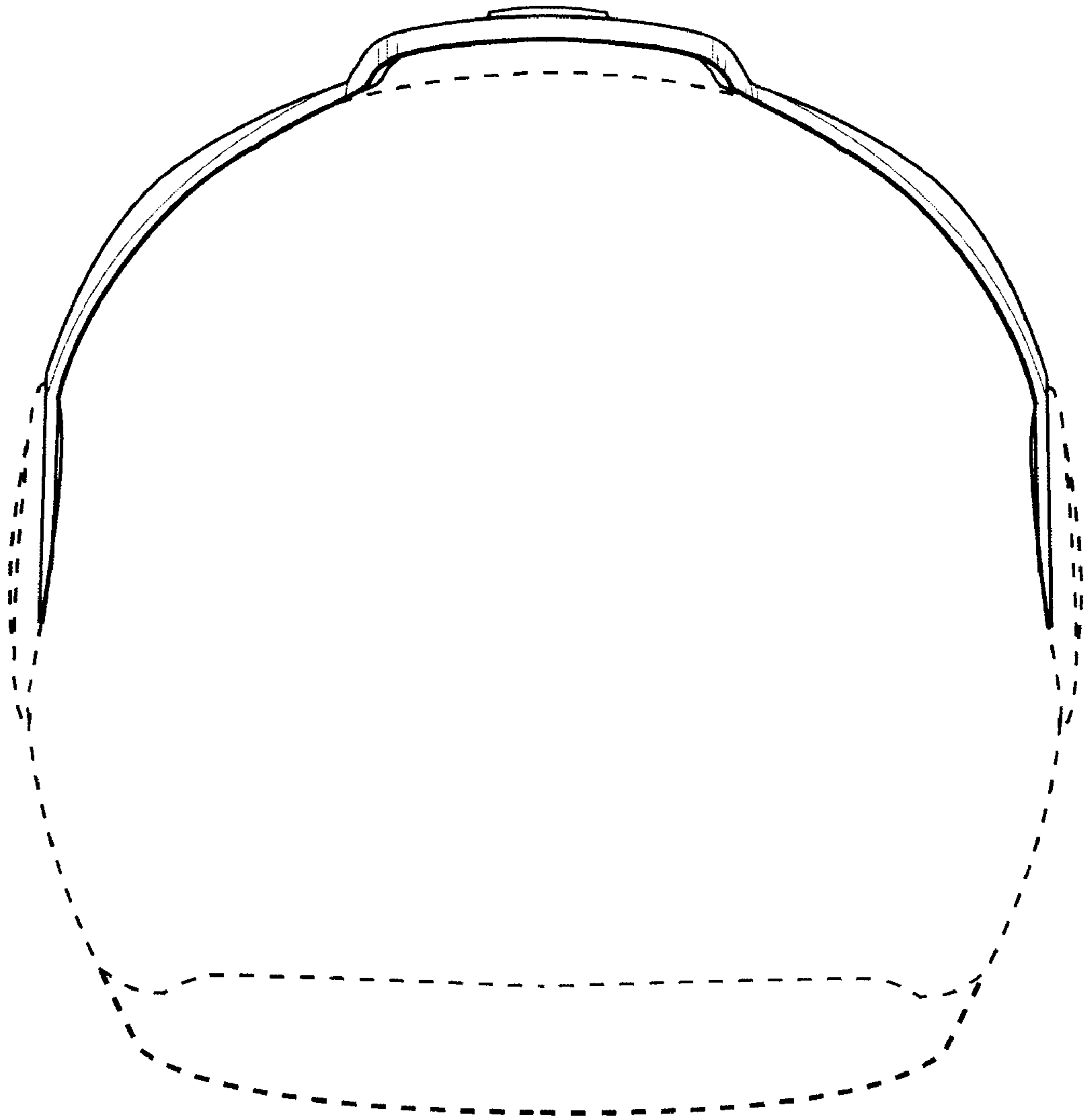
**FIG. 18**



**FIG. 19**



**FIG. 20**



**FIG. 21**