



US00D475798S

(12) **United States Design Patent**
Galli

(10) **Patent No.:** **US D475,798 S**

(45) **Date of Patent:** **** Jun. 10, 2003**

(54) **FLASHLIGHT**

D468,851 S * 1/2003 Galli D26/37

(76) **Inventor:** **Robert D. Galli**, 8176 Horseshoe Bend
La., Las Vegas, NV (US) 89113

* cited by examiner

(**) **Term:** **14 Years**

Primary Examiner—Marcus A. Jackson
(74) *Attorney, Agent, or Firm*—Barlow, Josephs & Holmes,
Ltd.

(21) **Appl. No.:** **29/168,690**

(57) **CLAIM**

(22) **Filed:** **Oct. 7, 2002**

The ornamental design for a flashlight, as shown and
described.

(51) **LOC (7) Cl.** **26-02**

(52) **U.S. Cl.** **D26/37**

(58) **Field of Search** D26/37-50; 362/157,
362/158, 171, 172, 173, 183-208

DESCRIPTION

(56) **References Cited**

U.S. PATENT DOCUMENTS

D434,164 S	11/2000	Galli	D26/49
D455,510 S	4/2002	Galli	D26/37
D455,513 S	4/2002	Galli	D26/49
D463,593 S	9/2002	Galli	D26/49
D468,464 S	* 1/2003	Galli	D26/37

FIG. 1 is a perspective view showing my new design for a
flashlight;
FIG. 2 is a top view thereof;
FIG. 3 is a left view thereof the right view being similar;
FIG. 4 is a bottom view thereof;
FIG. 5 is a front view thereof; and,
FIG. 6 is a rear view thereof.

1 Claim, 6 Drawing Sheets

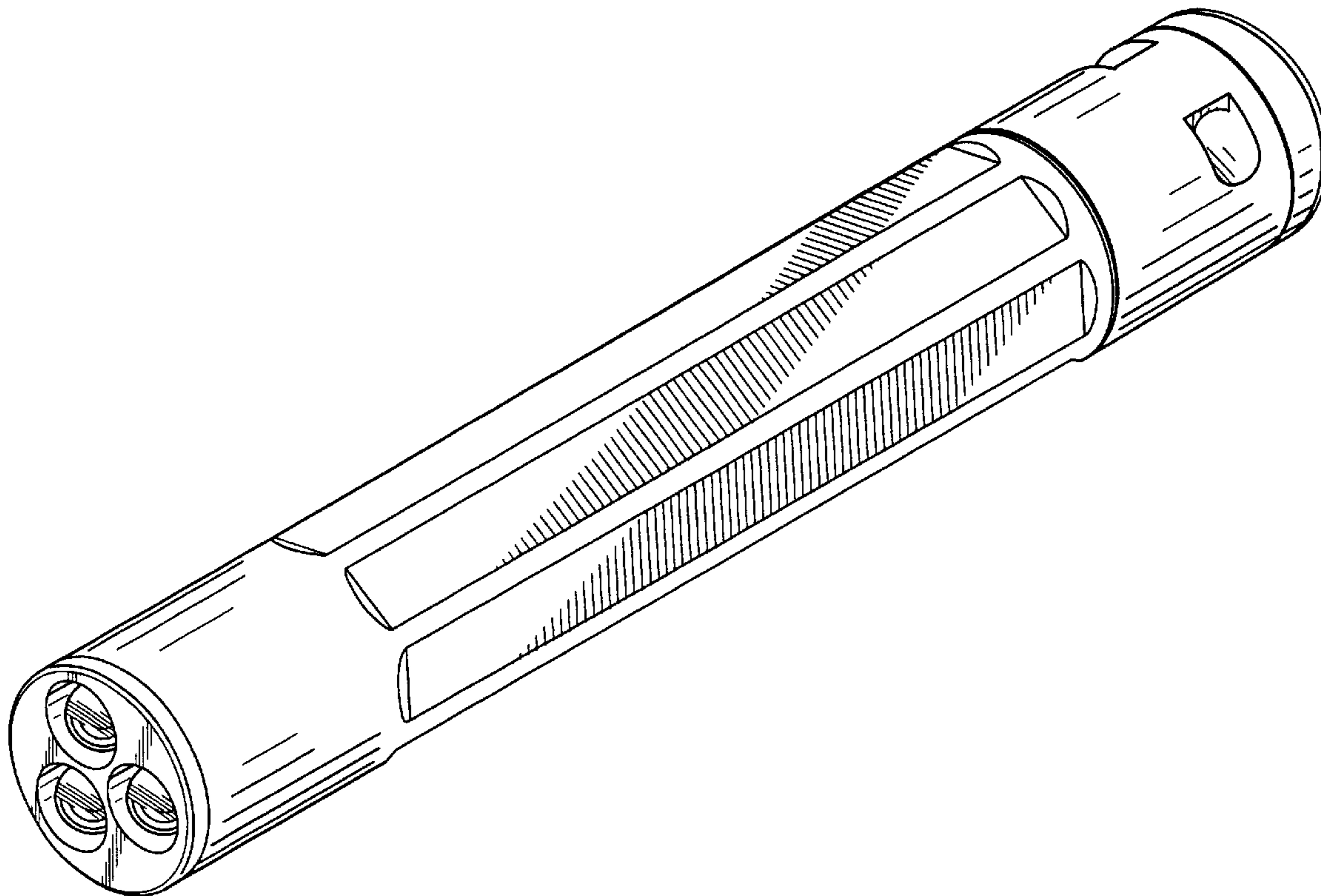

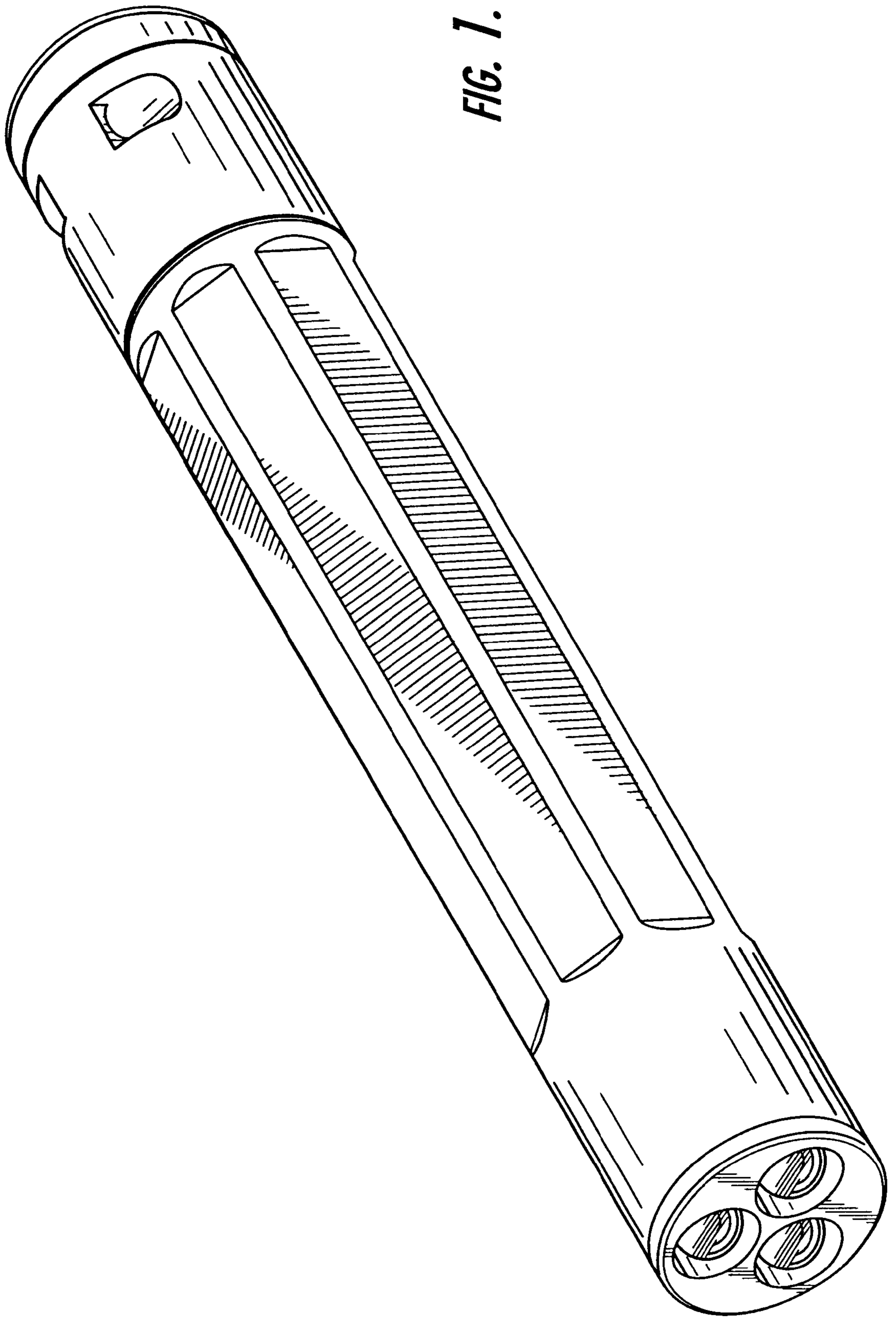

FIG. 1.

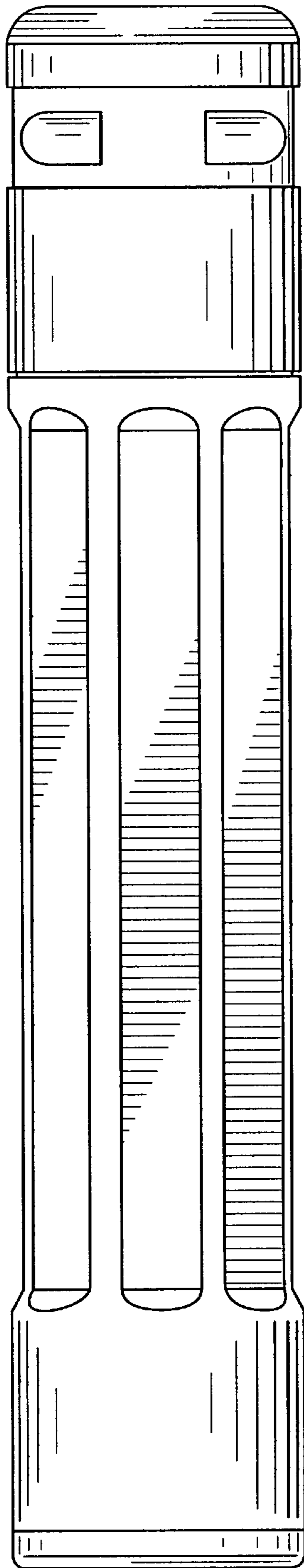

FIG. 2.

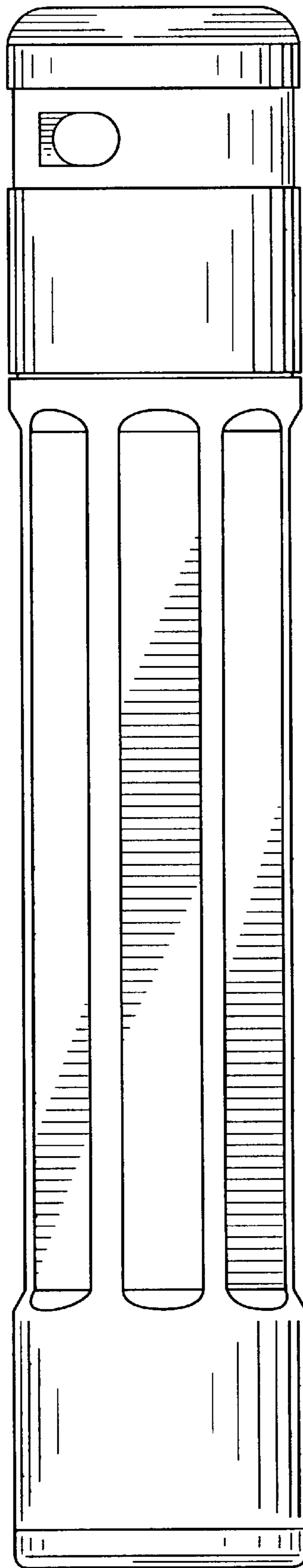

FIG. 3.

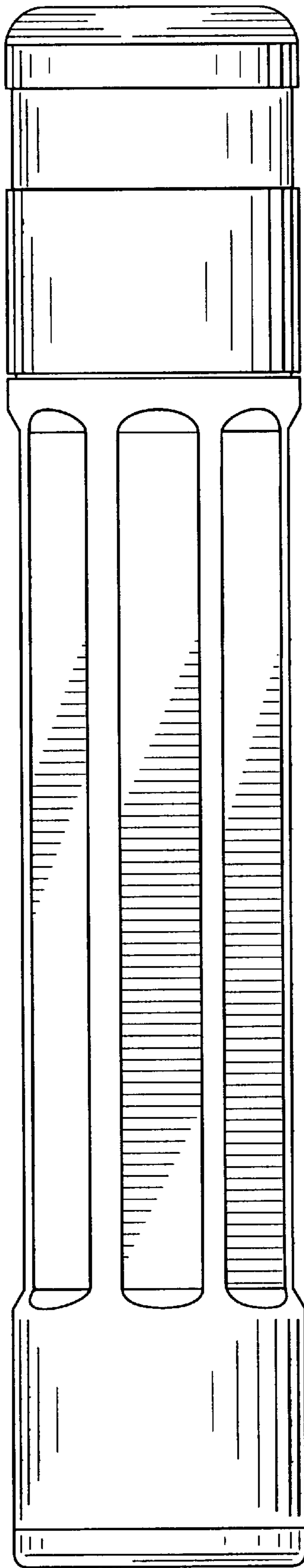

FIG. 4.

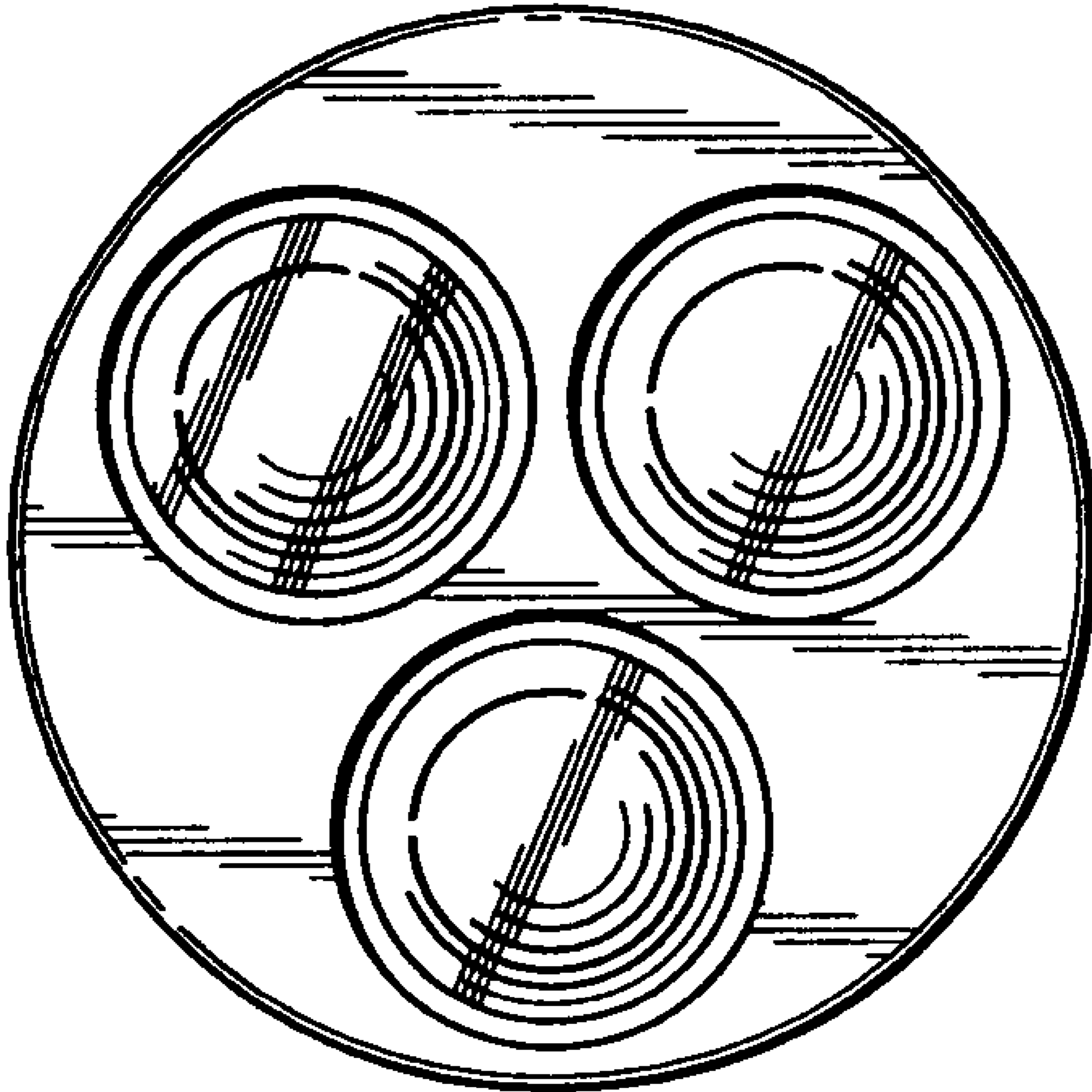

FIG. 5.

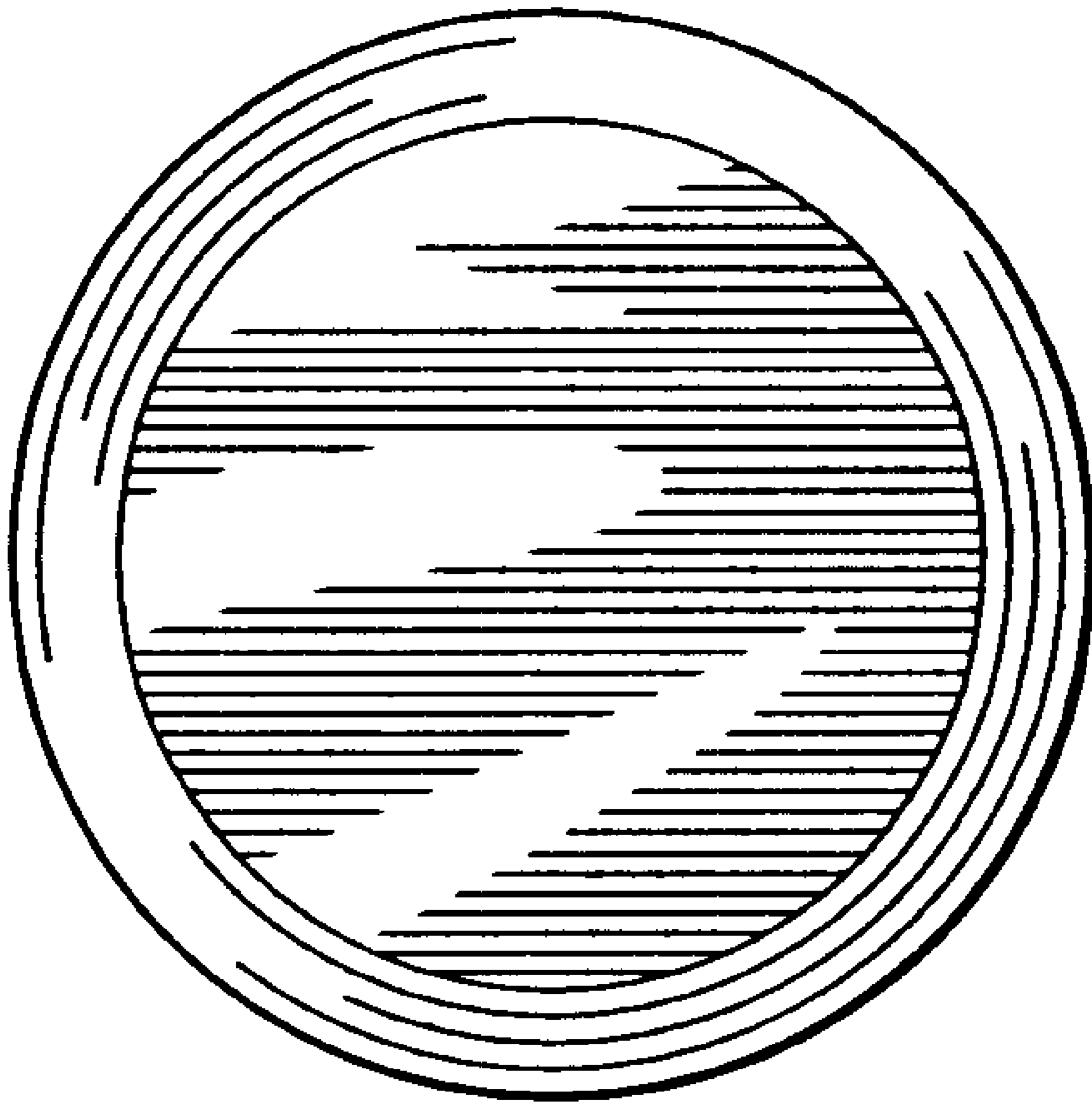

FIG. 6.