



US00D475747S

(12) **United States Design Patent** (10) **Patent No.:** **US D475,747 S**  
**Ono** (45) **Date of Patent:** **\*\* Jun. 10, 2003**

(54) **FILM-TRANSFERRING DEVICE FOR OFFICE USE**

(75) Inventor: **Satoru Ono**, Tokorozawa (JP)  
(73) Assignee: **Plus Stationery Corporation**, Tokyo (JP)  
(\*\*) Term: **14 Years**

(21) Appl. No.: **29/162,233**  
(22) Filed: **Jun. 11, 2002**

(30) **Foreign Application Priority Data**

Jan. 9, 2002 (JP) ..... 2002-000212

(51) **LOC (7) Cl.** ..... **19-06**  
(52) **U.S. Cl.** ..... **D19/69**  
(58) **Field of Search** ..... D19/53, 65, 66, D19/67-69, 72, 89, 99, 100; 225/6, 7, 11, 12, 19, 22, 25, 34, 35, 46, 56, 57, 77, 89; 242/588, 588.1-588.6, 590; 156/510, 327, 523, 527, 577; 15/104.93, 104.94

(56) **References Cited**

**U.S. PATENT DOCUMENTS**

5,393,368 A \* 2/1995 Stevens ..... 156/577

(List continued on next page.)

**OTHER PUBLICATIONS**

Jacobs Gardner Office Products Catalog, 2000, p. 464, see item B indicated, upper left corner.\*

*Primary Examiner*—Martie K. Holtje  
(74) *Attorney, Agent, or Firm*—Darby & Darby

(57) **CLAIM**

The ornamental design for a film-transferring device for office use, as shown and described.

**DESCRIPTION**

FIG. 1 is a plan view showing my new design for a film-transferring device for office use;

FIG. 2 is a front elevation view thereof;  
FIG. 3 is a cross-sectional view taken in the direction of arrows 3—3 in FIG. 1;  
FIG. 4 is a left side elevational view thereof;  
FIG. 5 is a right side elevational view thereof;  
FIG. 6 is a bottom view thereof;  
FIG. 7 is a rear elevational view thereof;  
FIG. 8 is a cross-sectional view taken in the direction of arrows 8—8 in FIG. 2;  
FIG. 9 is a cross-sectional view taken in the direction of arrows 9—9 in FIG. 2;  
FIG. 10 is a front elevational view in an in-use position with the cover member folded back, the ground line being shown for illustrative purposes only and forming no part of the claimed design;  
FIG. 11 is a top plan view of the body portion shown separately for each of illustration;  
FIG. 12 is a front elevational view of FIG. 11;  
FIG. 13 is a left side elevational view of FIG. 11;  
FIG. 14 is a right side elevational view of FIG. 11;  
FIG. 15 is a bottom plan view of FIG. 11;  
FIG. 16 is a rear elevational view of FIG. 11;  
FIG. 17 is a cross-sectional view taken in the direction of arrows 17—17 in FIG. 11;  
FIG. 18 is a cross-sectional view taken in the direction of arrows 18—18 in FIG. 12;  
FIG. 19 is a top plan view of the tape cassette portion shown separately for each of illustration;  
FIG. 20 is a front elevational view of FIG. 19;  
FIG. 21 is a cross-sectional view taken in the direction of arrows 21—21 in FIG. 20;  
FIG. 22 is a bottom plan view of FIG. 19;  
FIG. 23 is a rear elevational view of FIG. 19;  
FIG. 24 is a left side elevational view of FIG. 19;  
FIG. 25 is a right side elevational view of FIG. 19;  
FIG. 26 is a cross-sectional view taken in the direction of arrows 26—26 in FIG. 19;  
FIG. 27 is a cross-sectional view taken in the direction of arrows 27—27 in FIG. 20;  
FIG. 28 is a perspective view of FIG. 1;  
FIG. 29 is a perspective view of FIG. 11; and,  
FIG. 30 is a perspective view of FIG. 19.

**1 Claim, 8 Drawing Sheets**

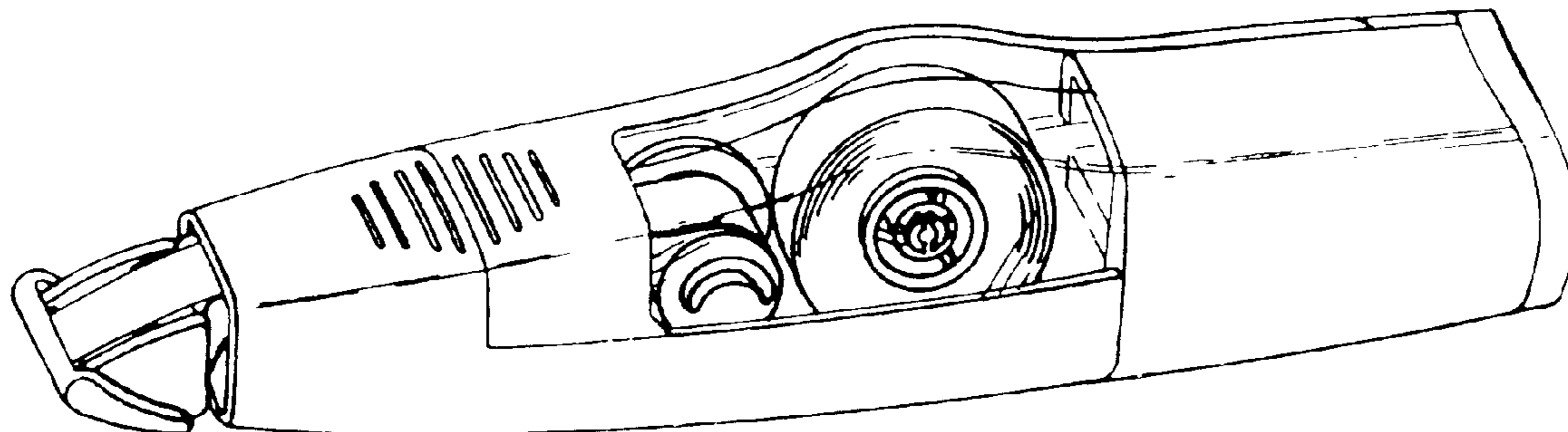

# US D475,747 S

Page 2

---

## U.S. PATENT DOCUMENTS

D467,617 S \* 12/2002 Soetewey ..... D19/69

5,772,840 A \* 6/1998 Morinaga ..... 156/540

6,112,796 A \* 9/2000 Stevens ..... 156/577

\* cited by examiner

Fig. 1

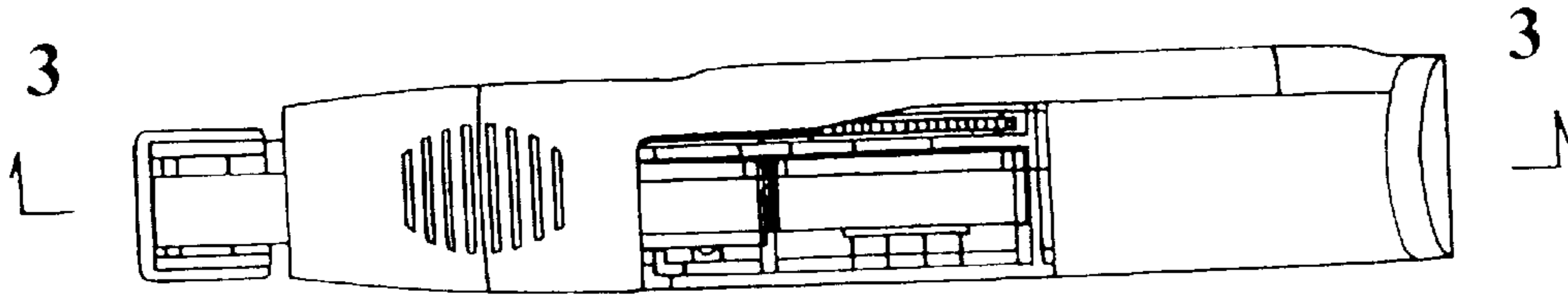

Fig. 2

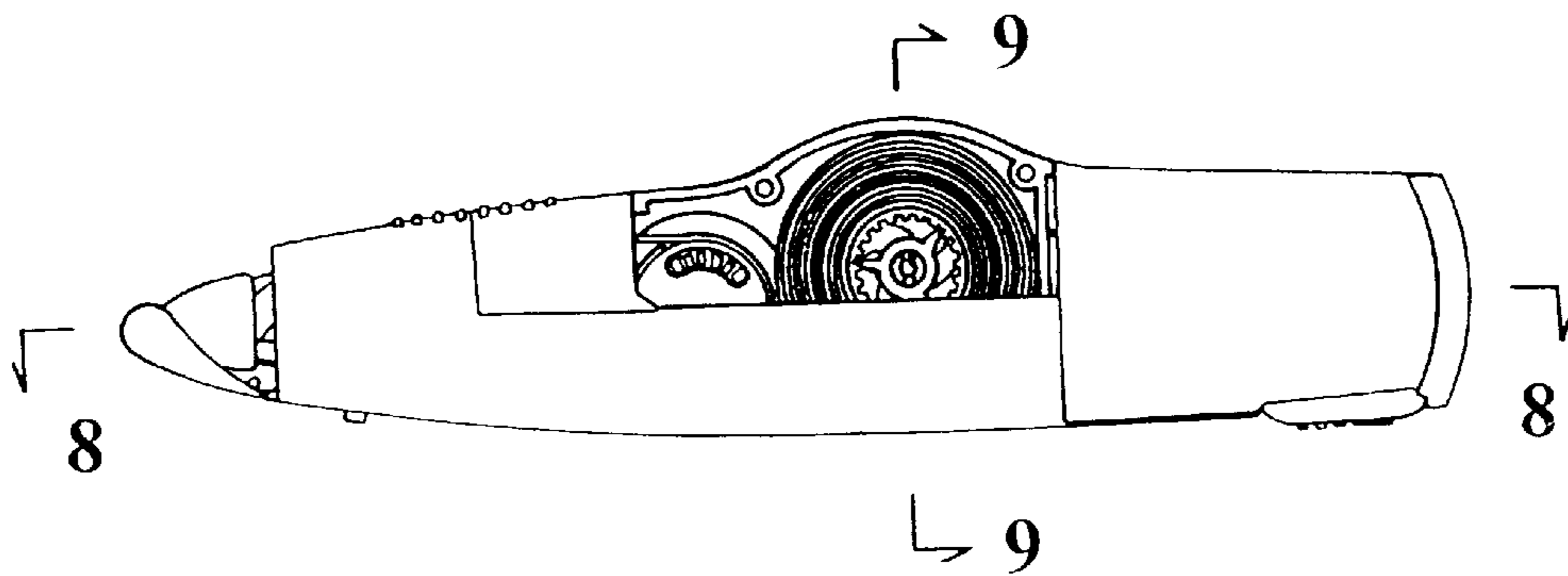

Fig. 3

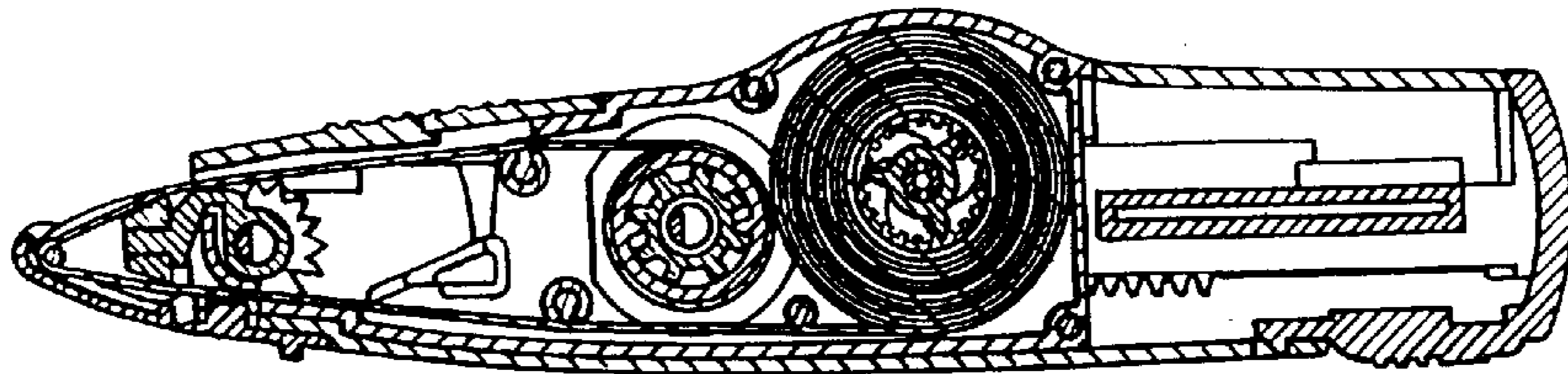

Fig. 4

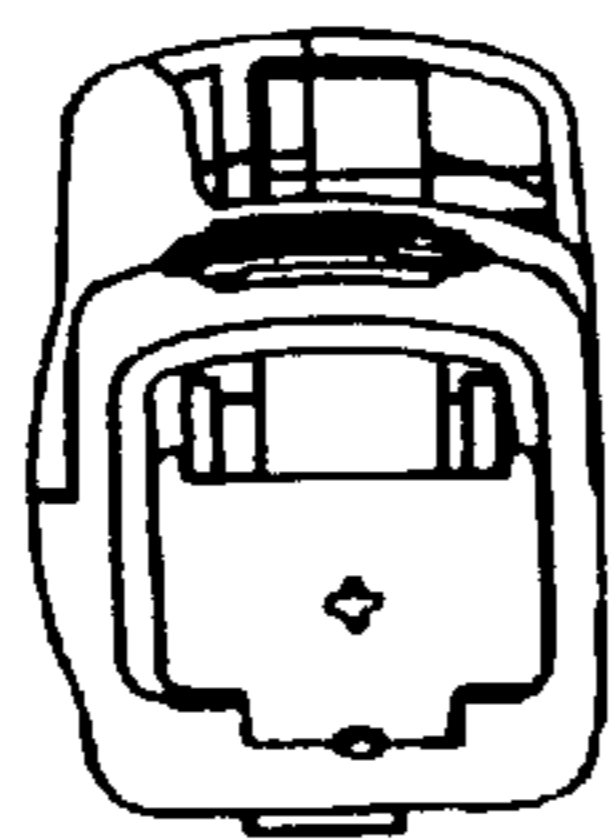

Fig. 5

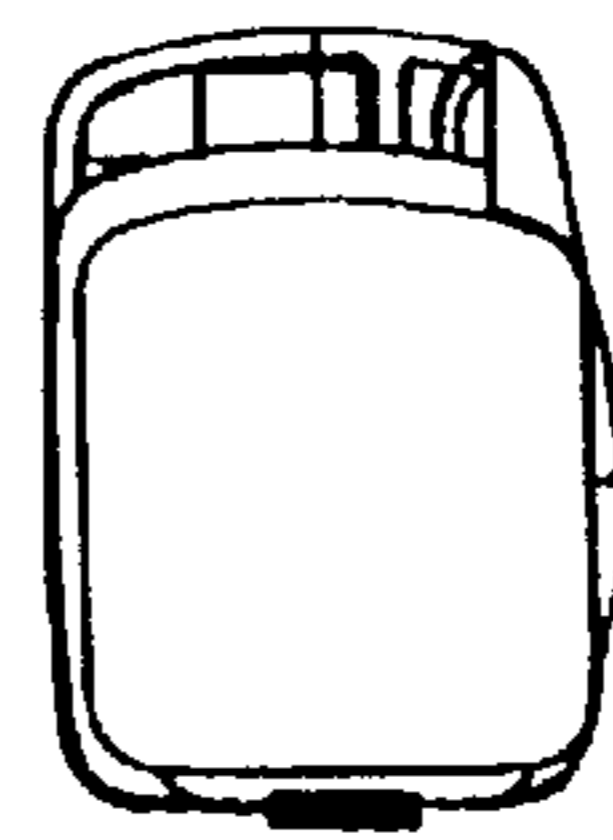

Fig. 6

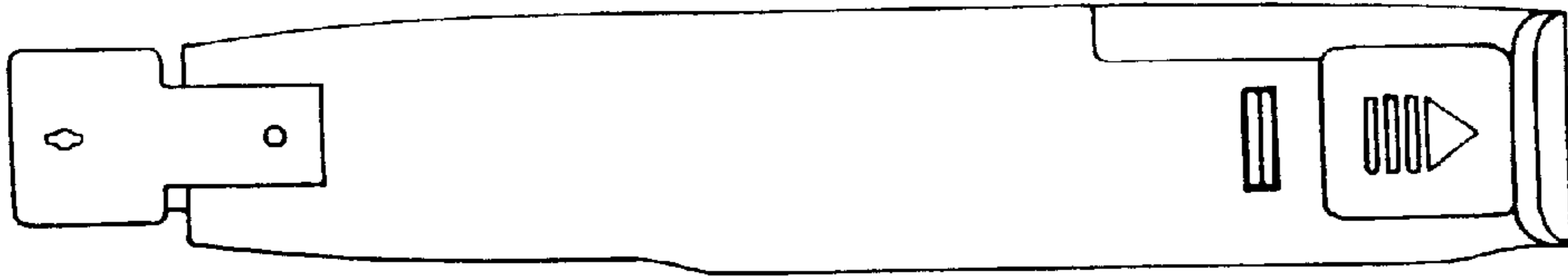

Fig. 7

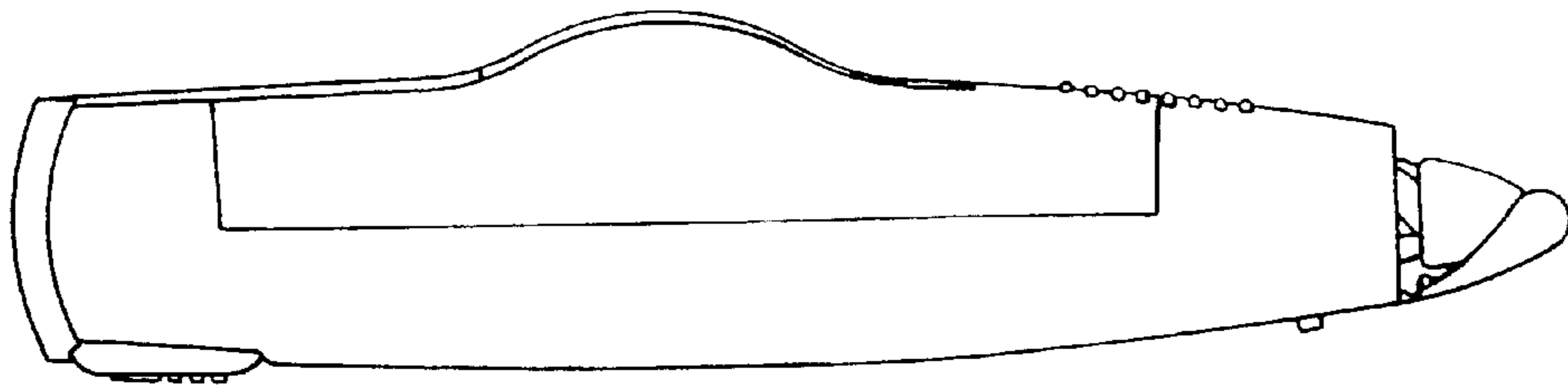

Fig. 8

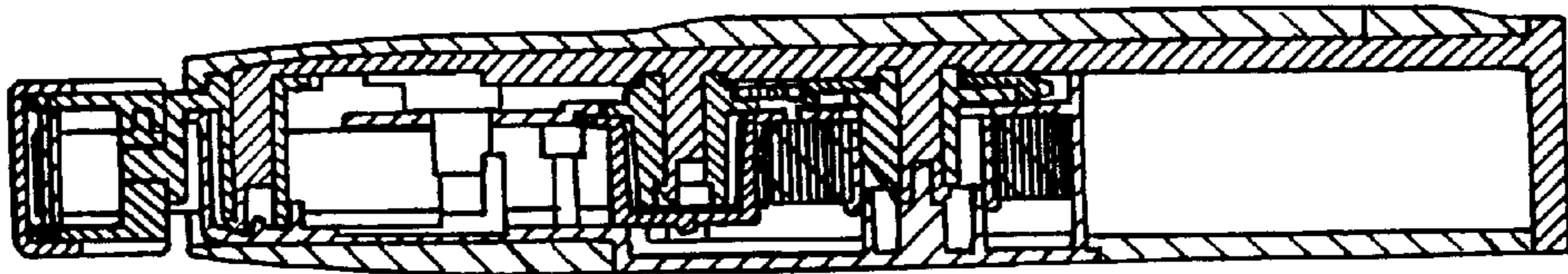

Fig. 9

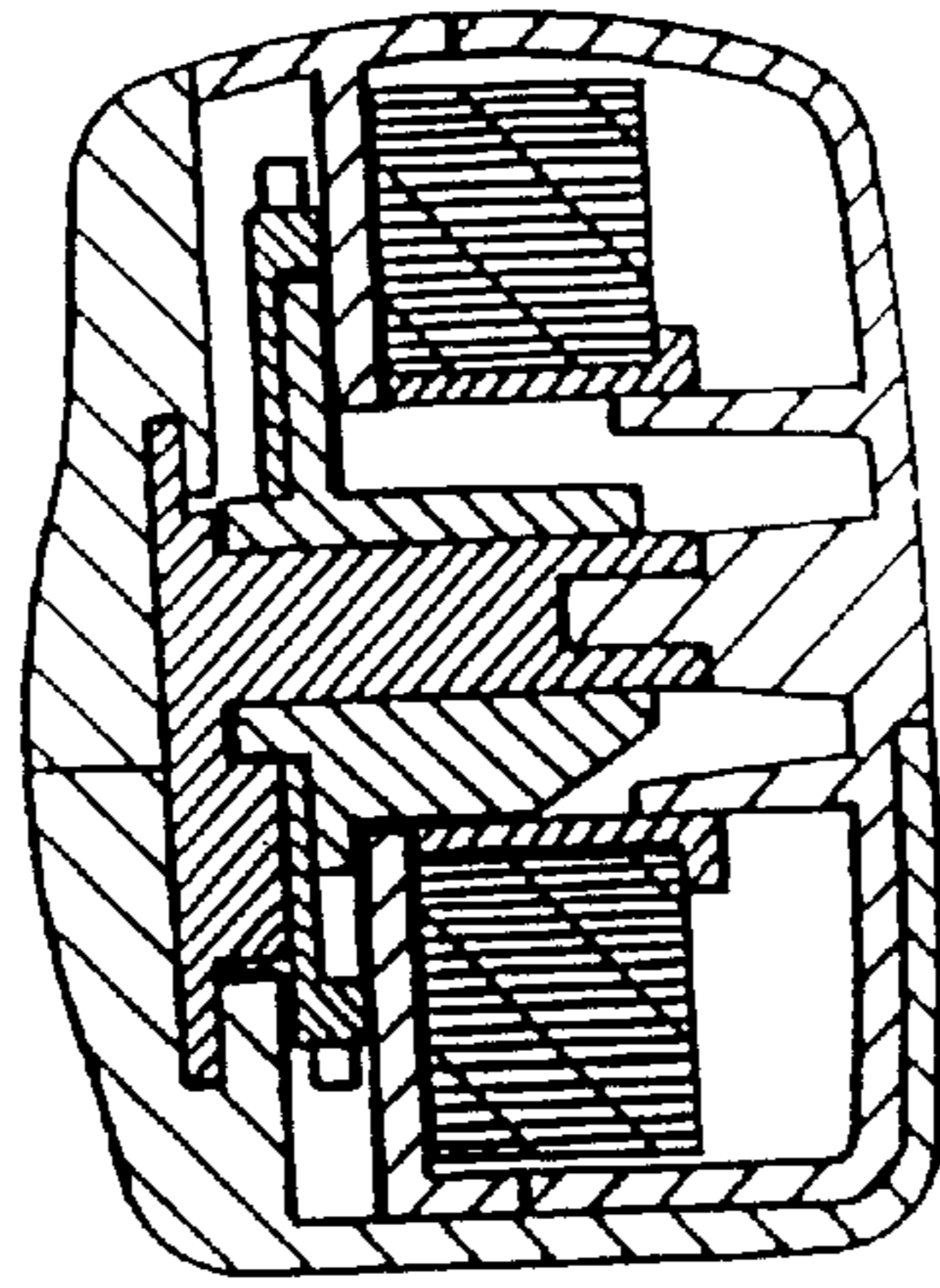

Fig. 10

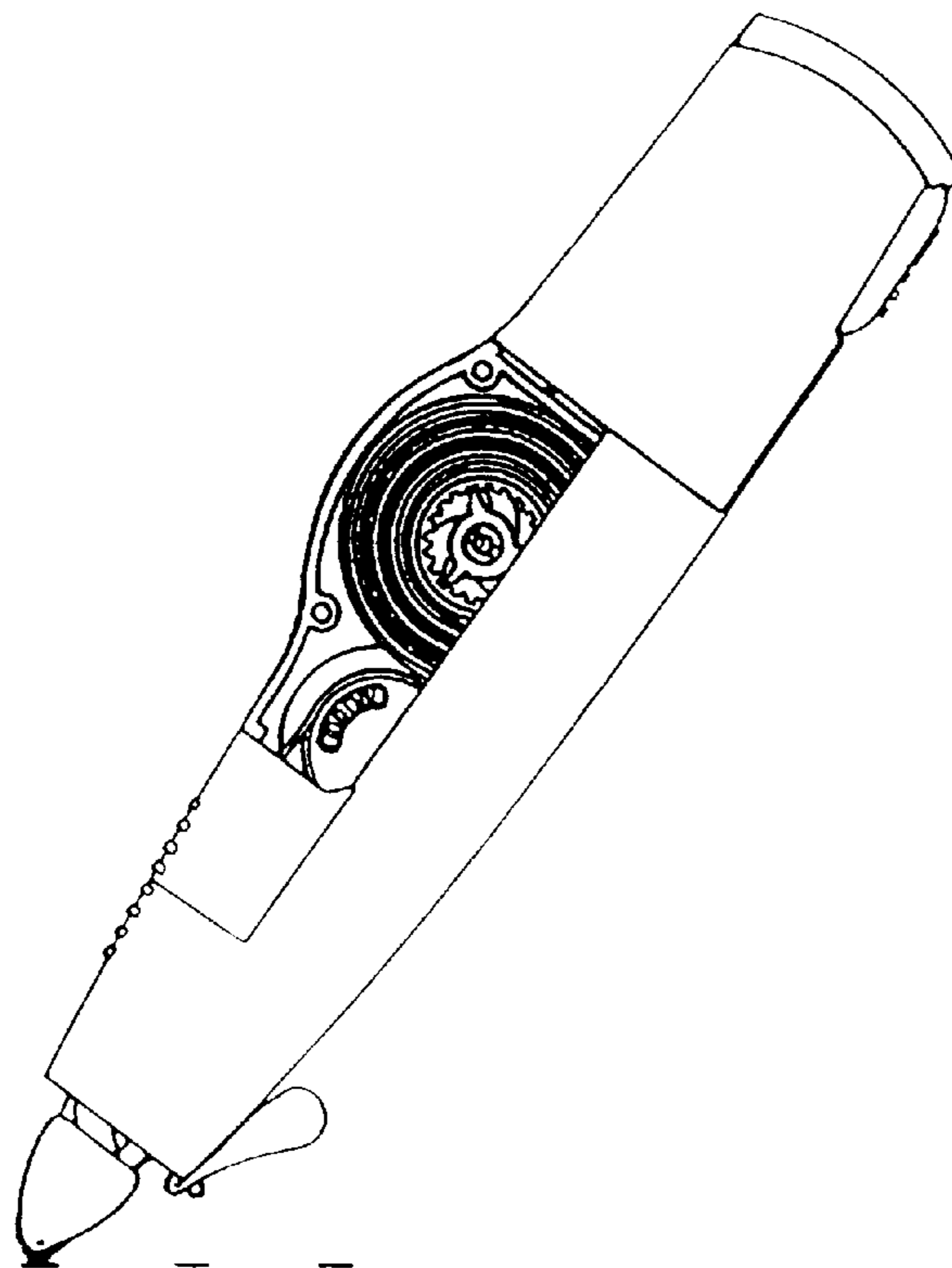

Fig. 11

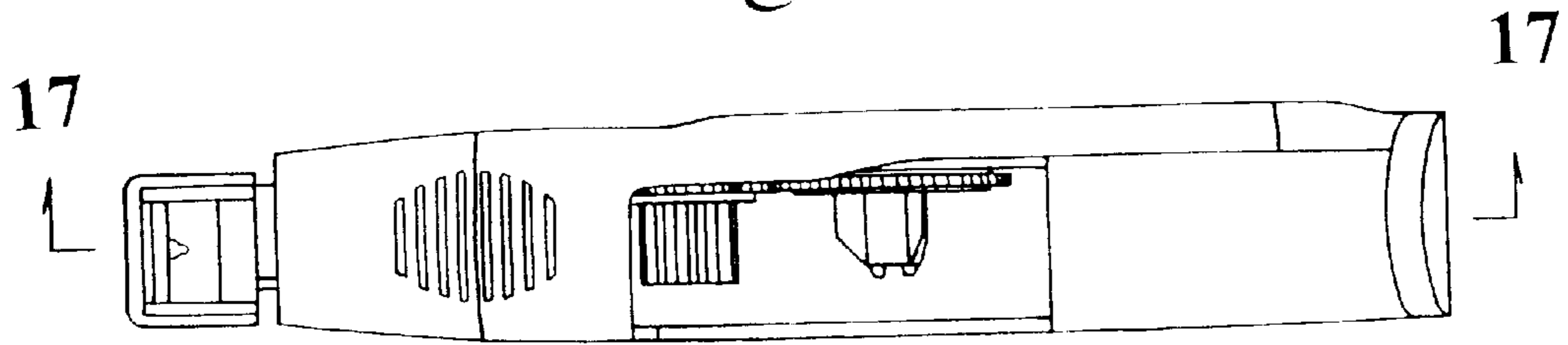

Fig. 12

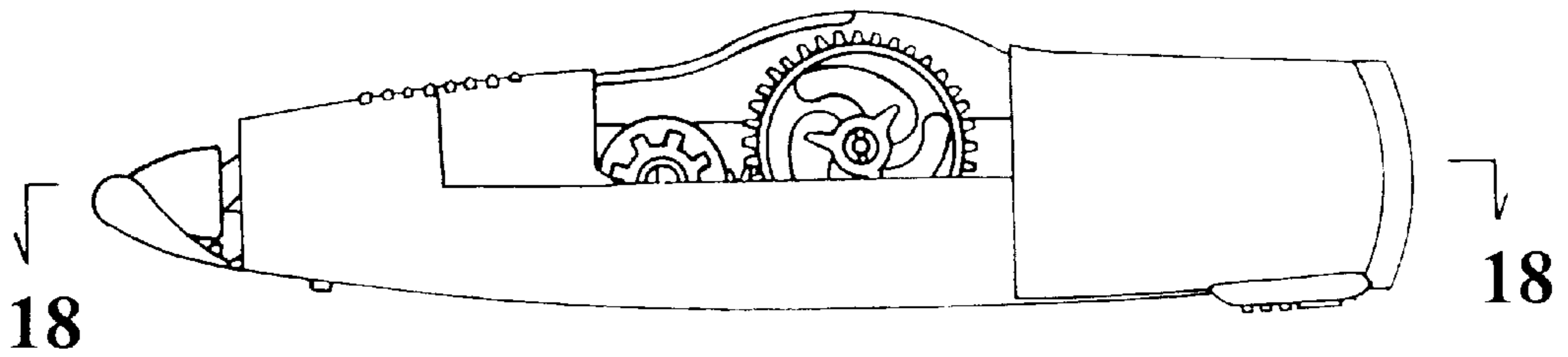

Fig. 13

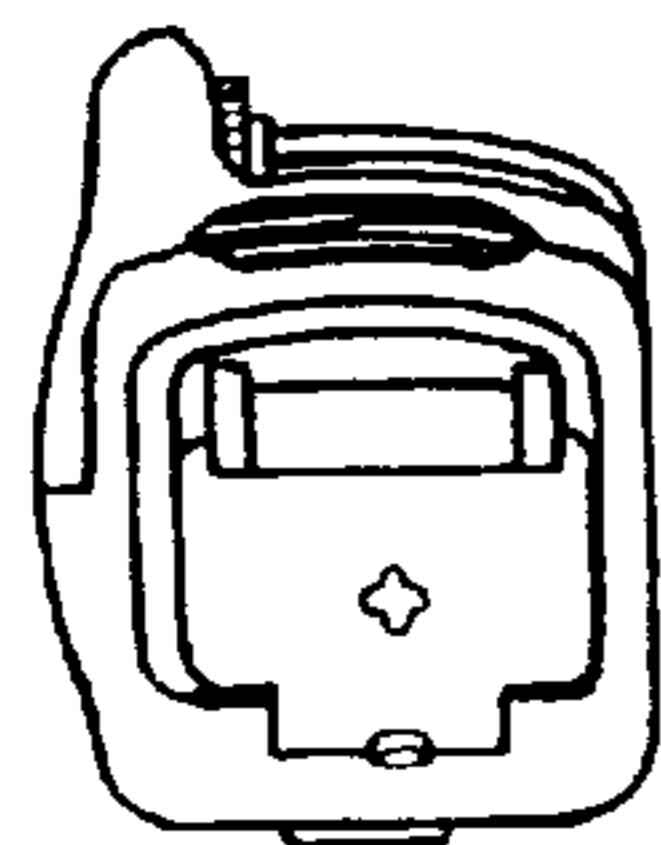

Fig. 14

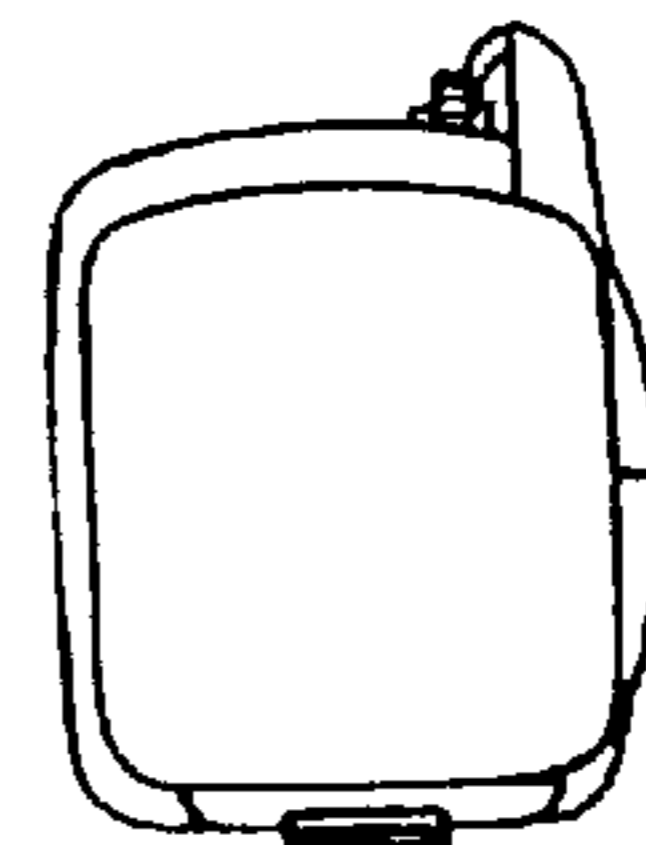

Fig. 15

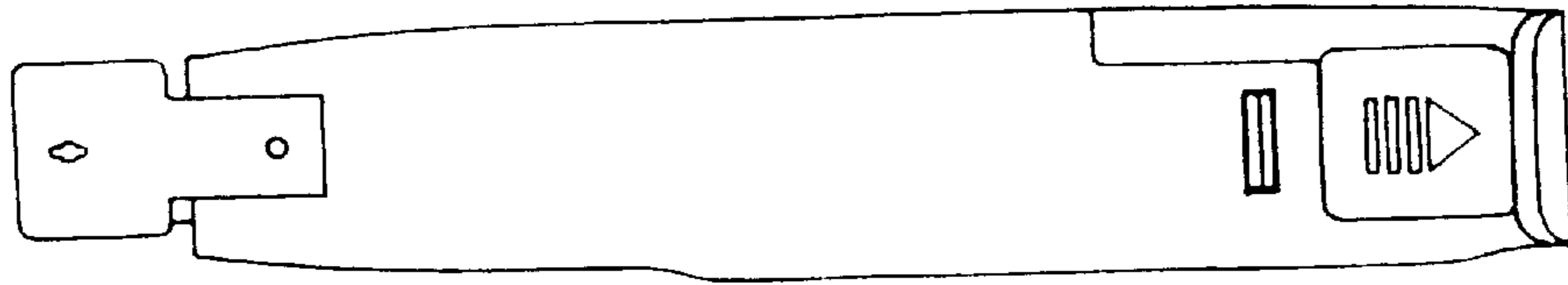

Fig. 16

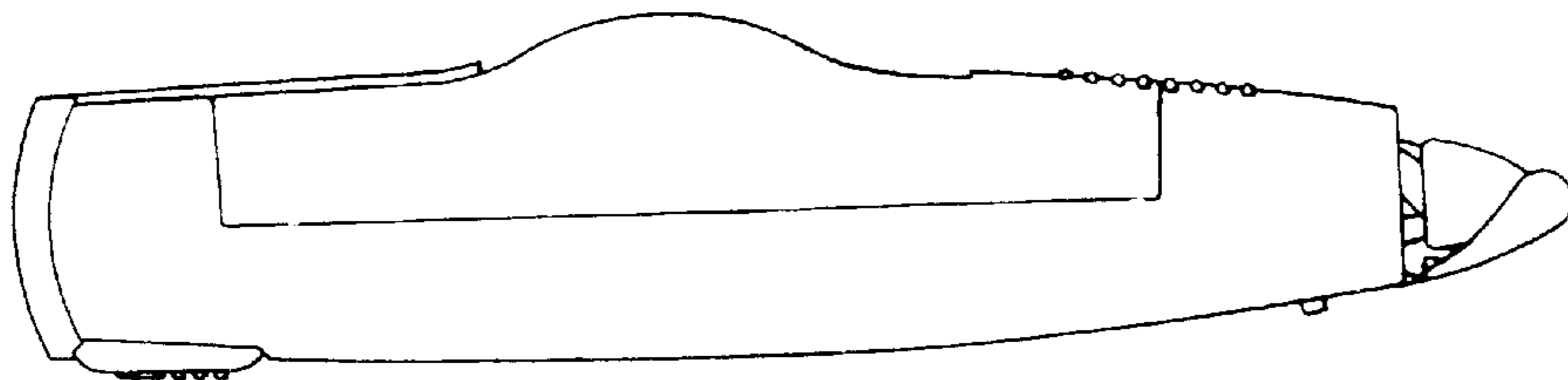

Fig. 17

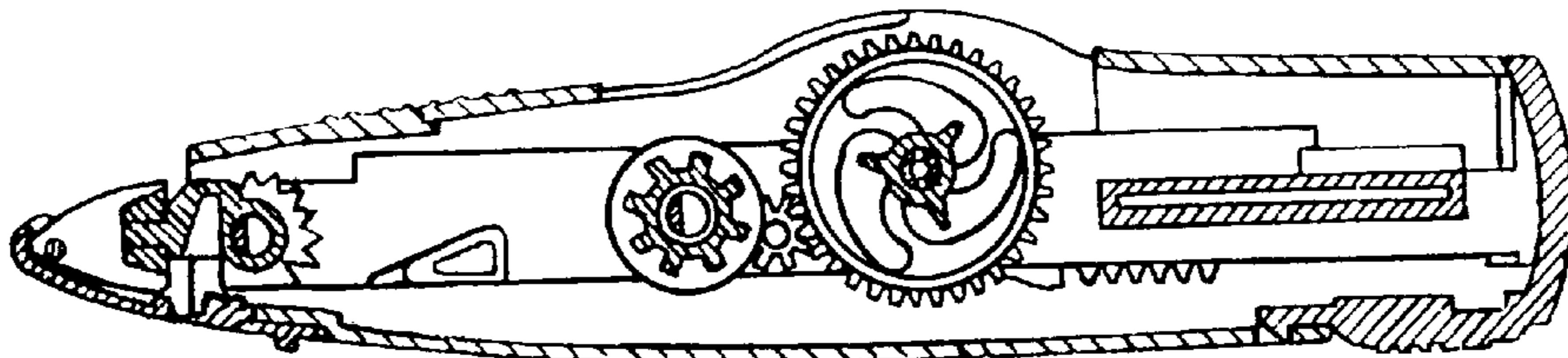
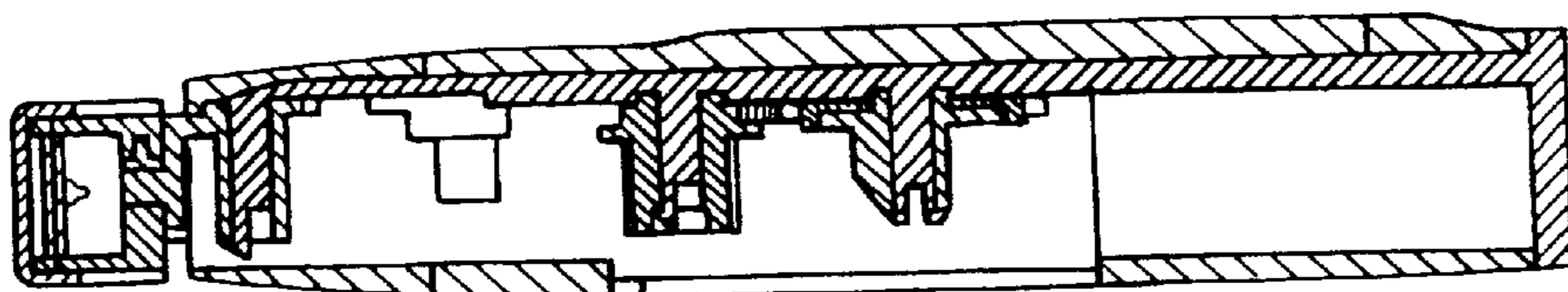

Fig. 18



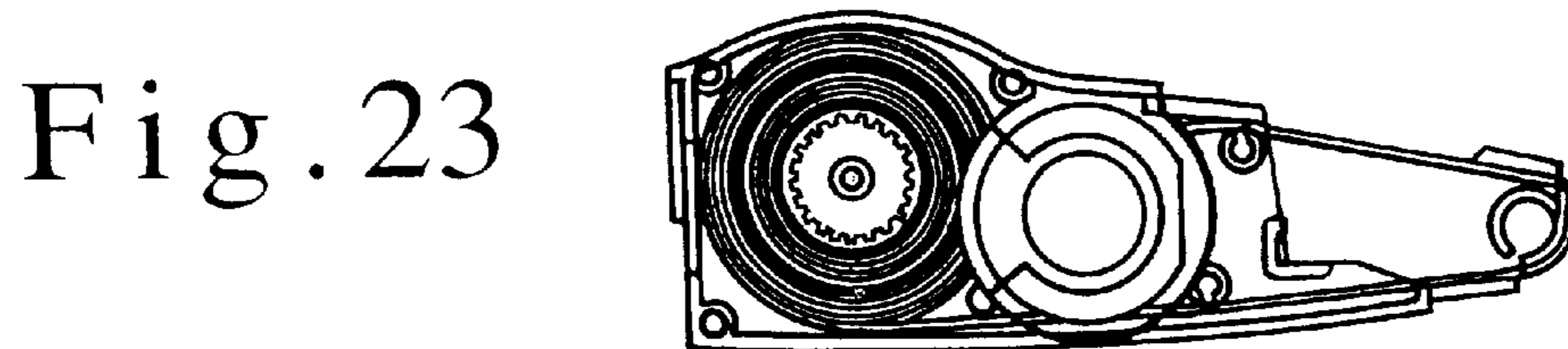
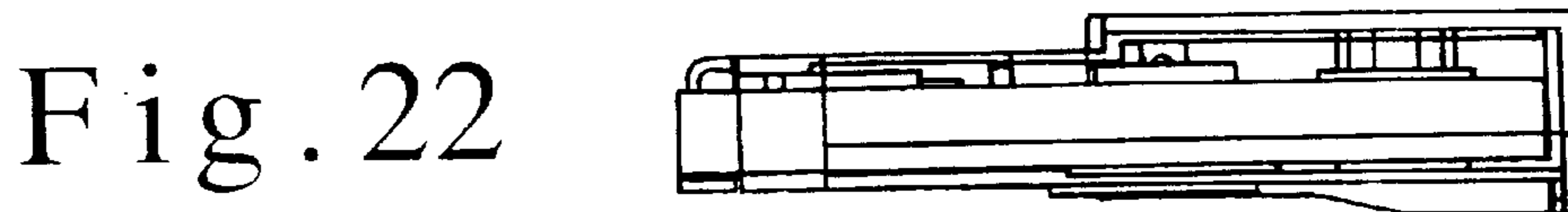
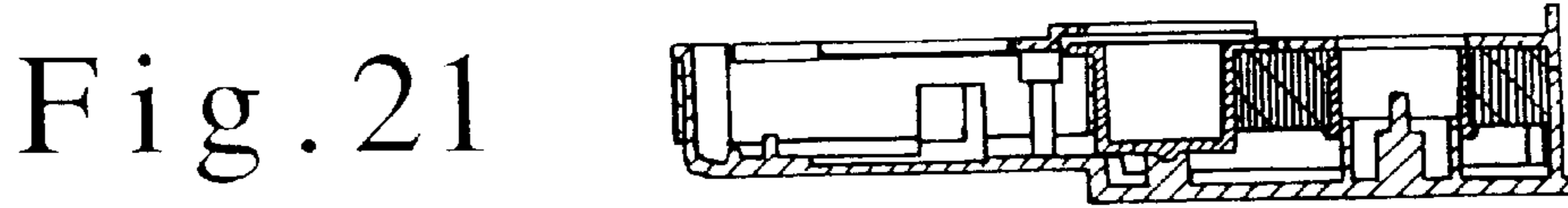
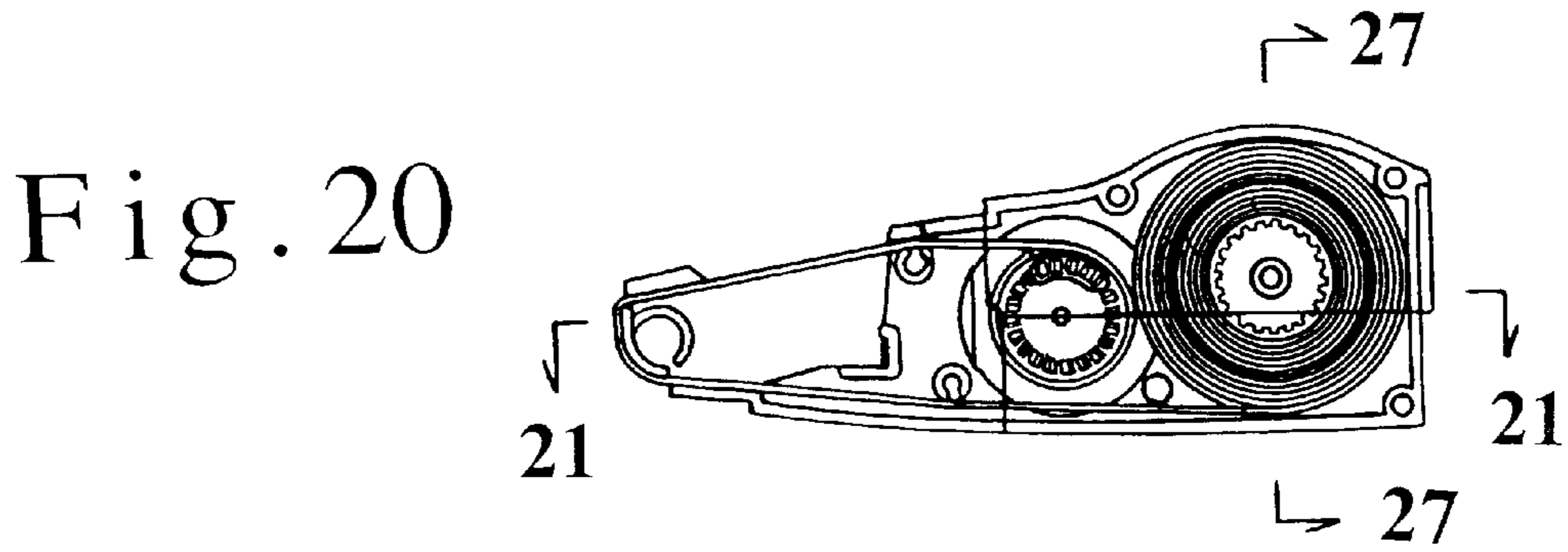
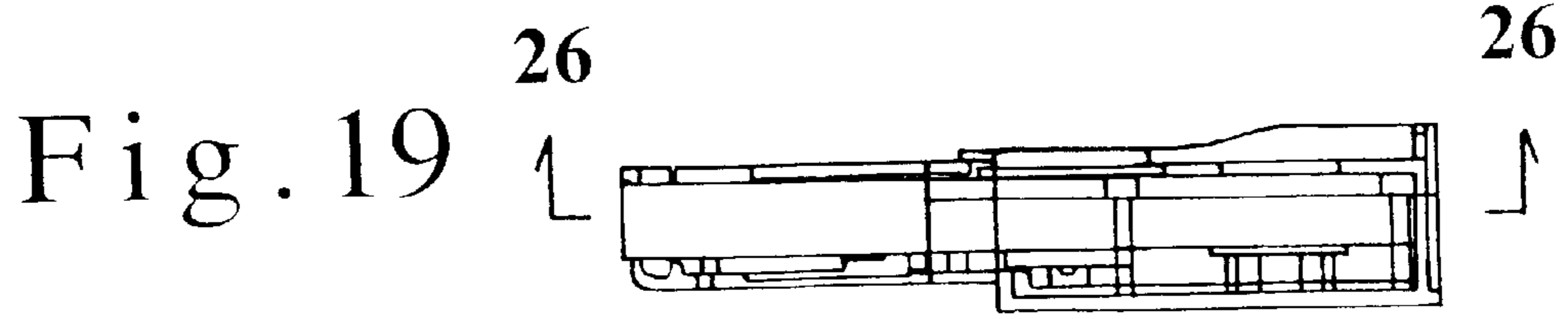



Fig. 24

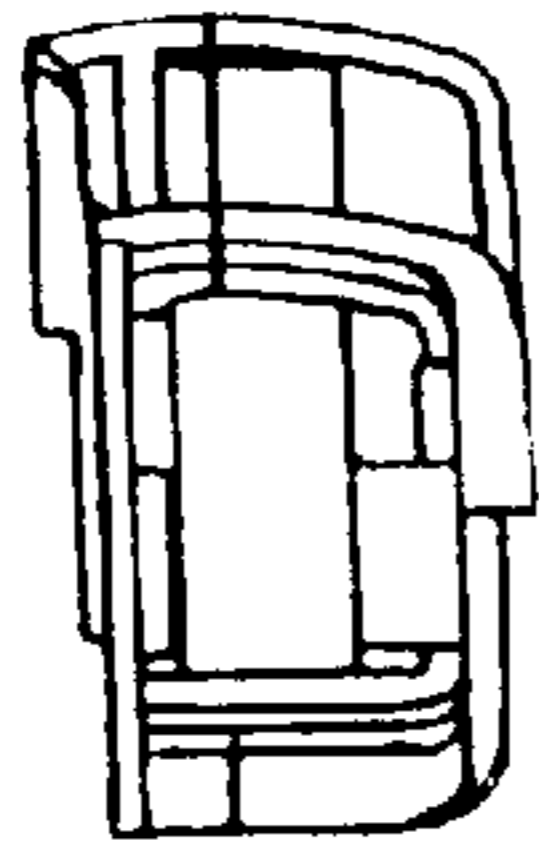

Fig. 25

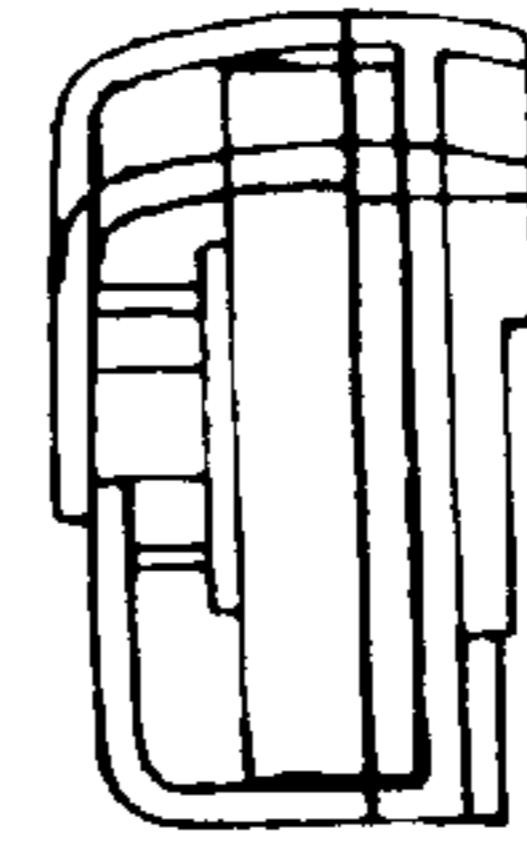

Fig. 26

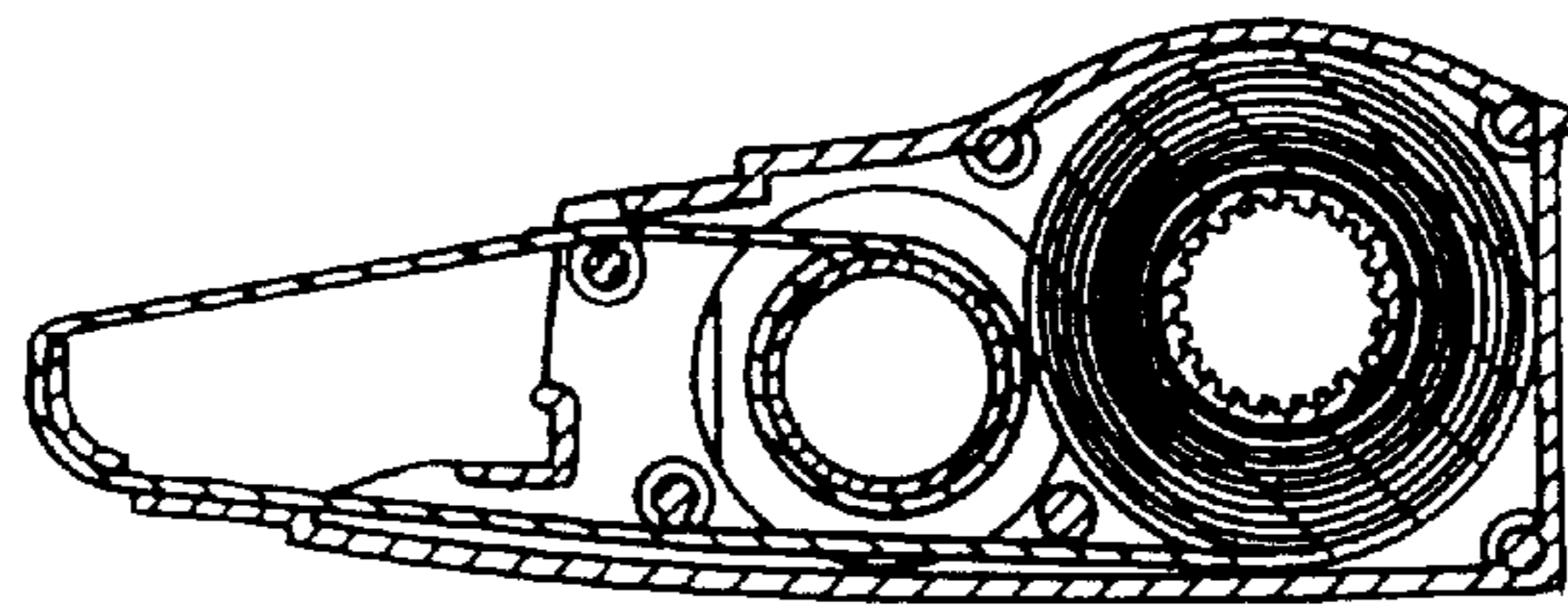

Fig. 27

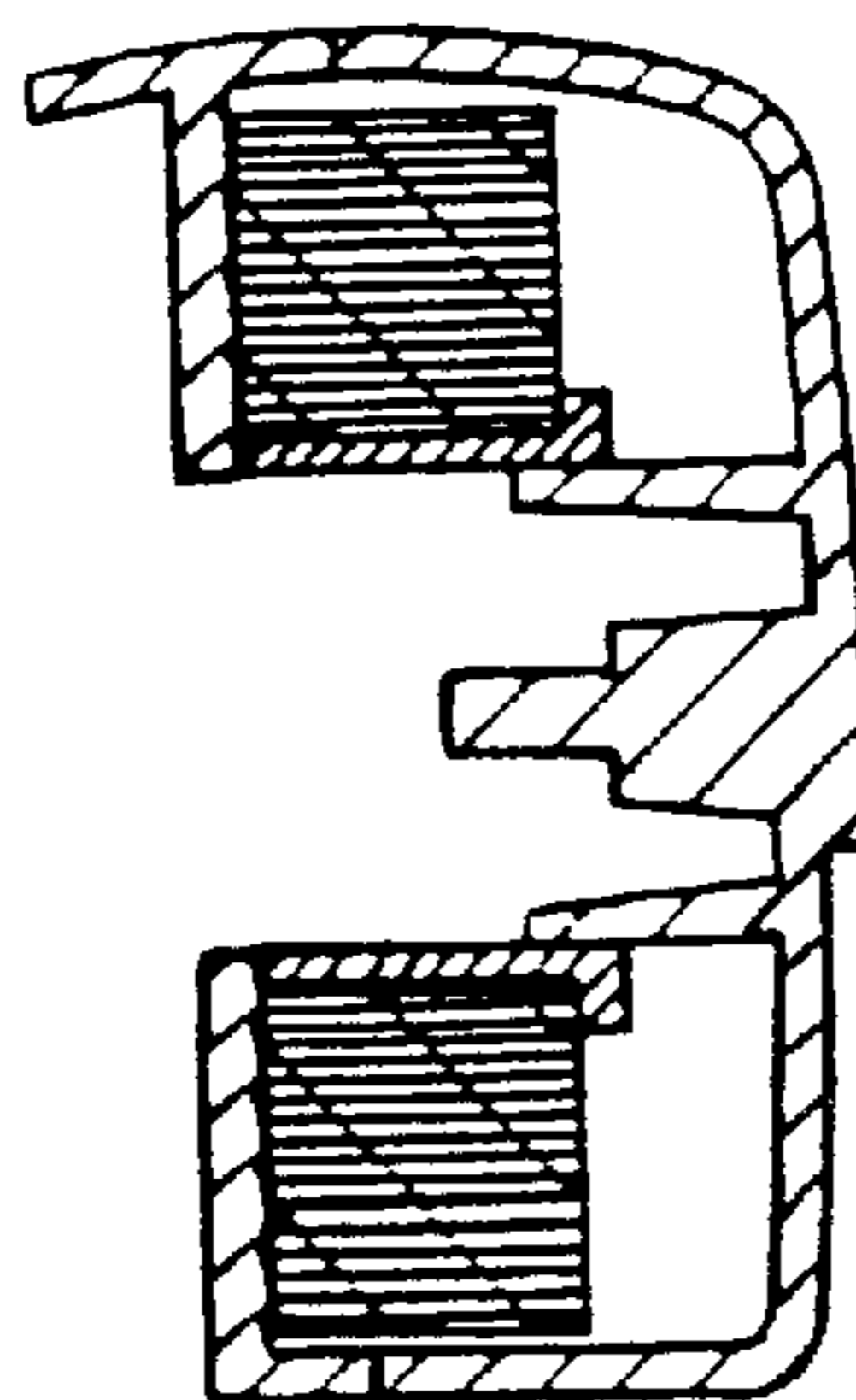

Fig. 28

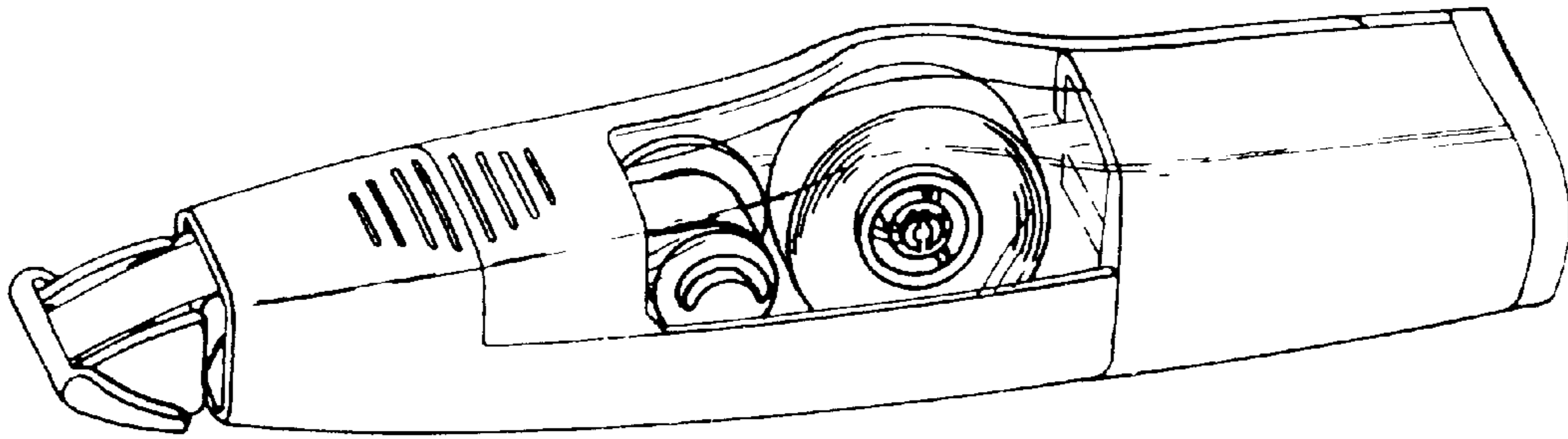

Fig. 29

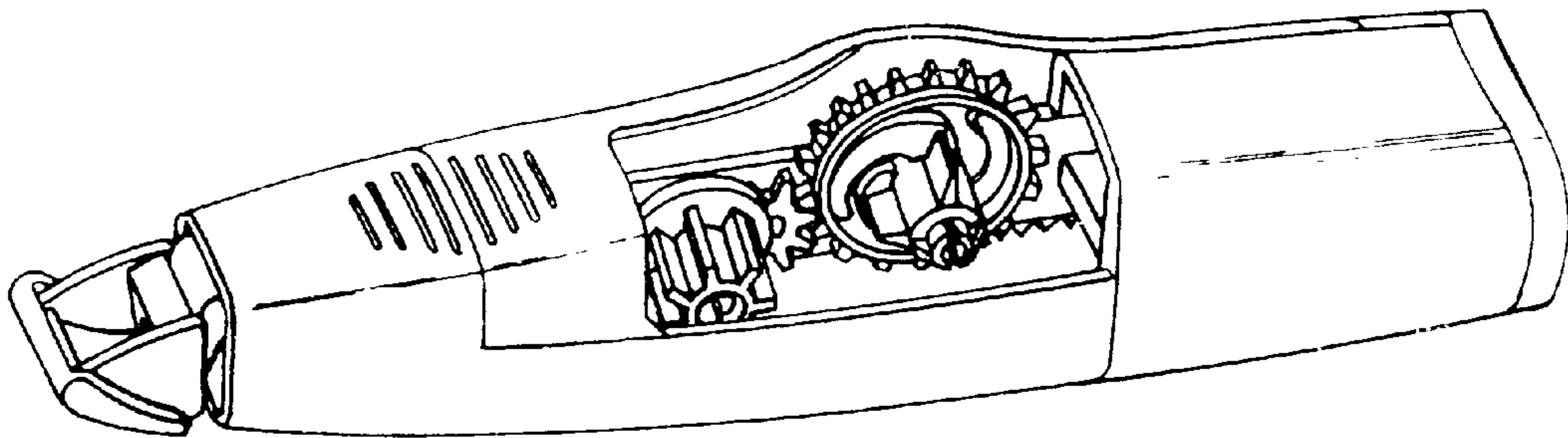

Fig. 30

