



US00D475744S

(12) **United States Design Patent**
De Man et al.

(10) **Patent No.:** **US D475,744 S**

(45) **Date of Patent:** **** Jun. 10, 2003**

(54) **TAPE DISPENSER**

(75) Inventors: **Eelco H. De Man**, Helmond (NL);
Stephan Blom, Helmond (NL); **Erwin P. Boes**, Nijmegen (NL)

(73) Assignee: **Ray Technology Group B.V.**, Drunen (NL)

(**) Term: **14 Years**

(21) Appl. No.: **29/162,129**

(22) Filed: **Jun. 10, 2002**

(30) **Foreign Application Priority Data**

Dec. 10, 2001 (WO) DM/058 645

(51) **LOC (7) Cl.** **19-02**

(52) **U.S. Cl.** **D19/69; D19/67**

(58) **Field of Search** D19/53, 65, 66,
D19/67-69, 72, 89, 99, 100; 225/6, 7, 11,
12, 19, 14, 22, 25, 34, 35, 46, 56, 57, 77,
89; 242/588, 588.1-588.6, 590; 156/510,
327, 523, 527, 577; 15/104.93, 104.94;
83/610

(56) **References Cited**

U.S. PATENT DOCUMENTS

D144,392 S	*	4/1946	Krueger	D19/69
2,864,446 A	*	12/1958	Olson et al.	83/610
D188,519 S	*	8/1960	Gershen	D19/69
3,035,345 A	*	5/1962	Barnard	225/14 X
D202,949 S	*	11/1965	Petterson	D19/69
4,630,765 A	*	12/1986	Samuelson et al.	225/96
D294,955 S	*	3/1988	Ragnerstam	D19/67
D305,249 S	*	12/1989	Ukisu	D19/69 X
D441,795 S	*	5/2001	De Regt et al.	D19/69

* cited by examiner

Primary Examiner—Martie K. Holtje

(74) *Attorney, Agent, or Firm*—Bell, Boyd & Lloyd LLC

(57) **CLAIM**

The ornamental design for a tape dispenser, as shown and described.

DESCRIPTION

FIG. 1 is a perspective front top view according to the present invention.

FIG. 2 is a perspective front top view in opened position according to the present invention.

FIG. 3 is a perspective left side view from above according to the present invention.

FIG. 4 is a perspective left side view from above in opened position according to the present invention.

FIG. 5 is a right side view according to the present invention.

FIG. 6 is a right side view in opened position according to the present invention.

FIG. 7 is a left side view according to the present invention.

FIG. 8 is a left side view in opened position according to the present invention.

FIG. 9 is a top view in opened position according to the present invention.

FIG. 10 is a top view according to the present invention.

FIG. 11 is a front view according to the present invention.

FIG. 12 is a front view in opened position according to the present invention.

FIG. 13 is a back view according to the present invention.

FIG. 14 is a back view in opened position according to the present invention.

FIG. 15 is a bottom view according to the present invention; and,

FIG. 16 is a bottom view in opened position according to the present invention.

1 Claim, 2 Drawing Sheets

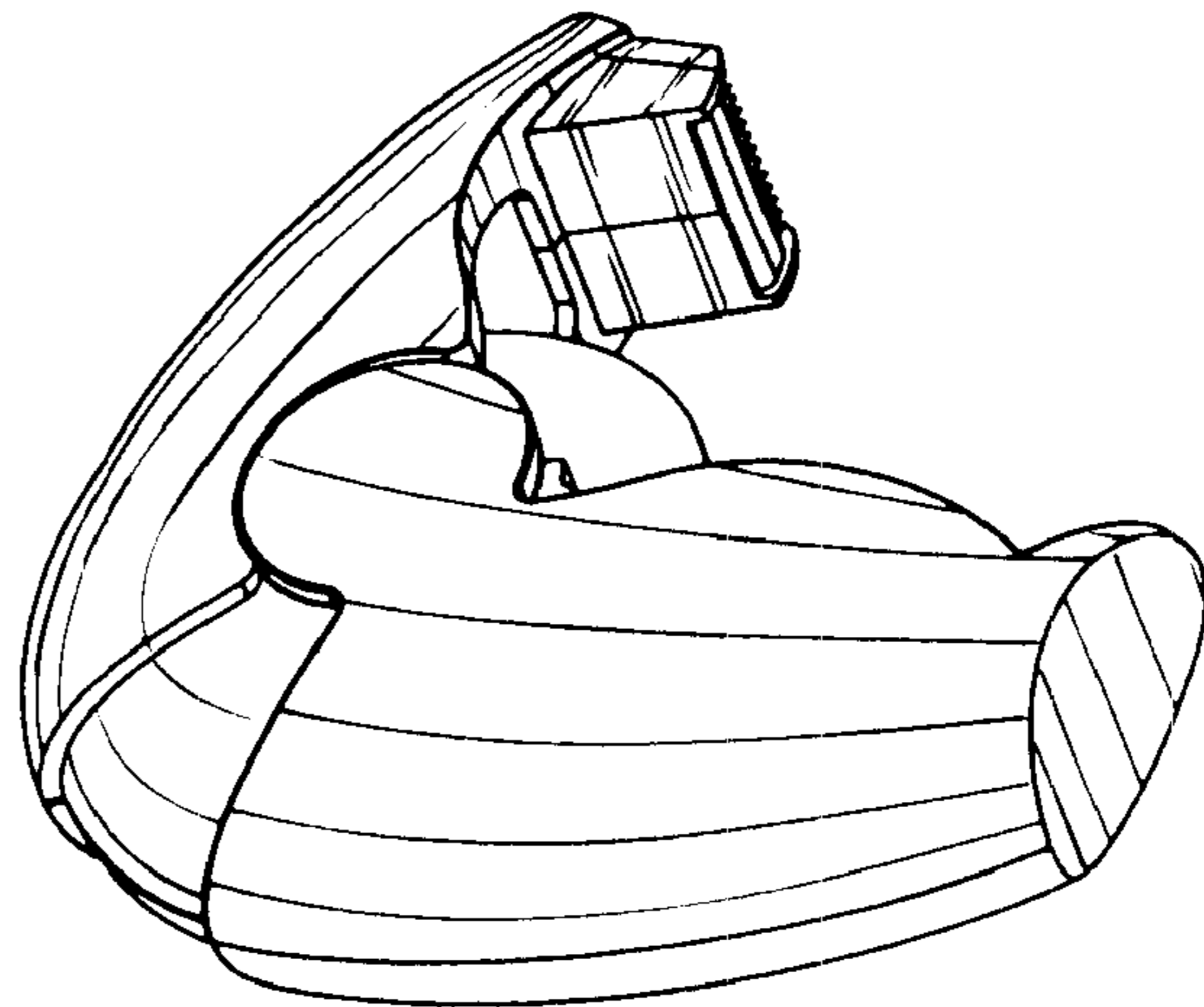
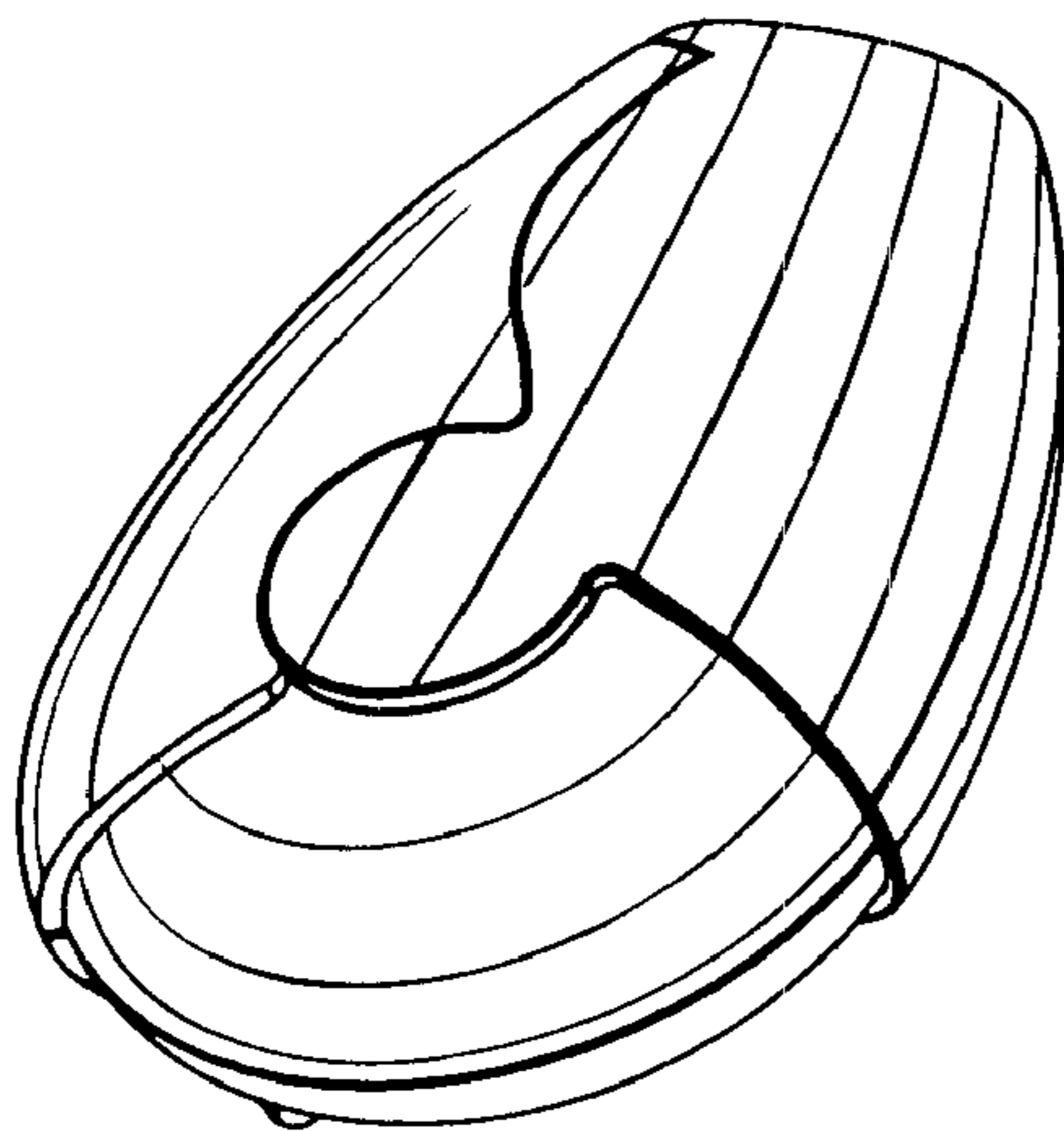

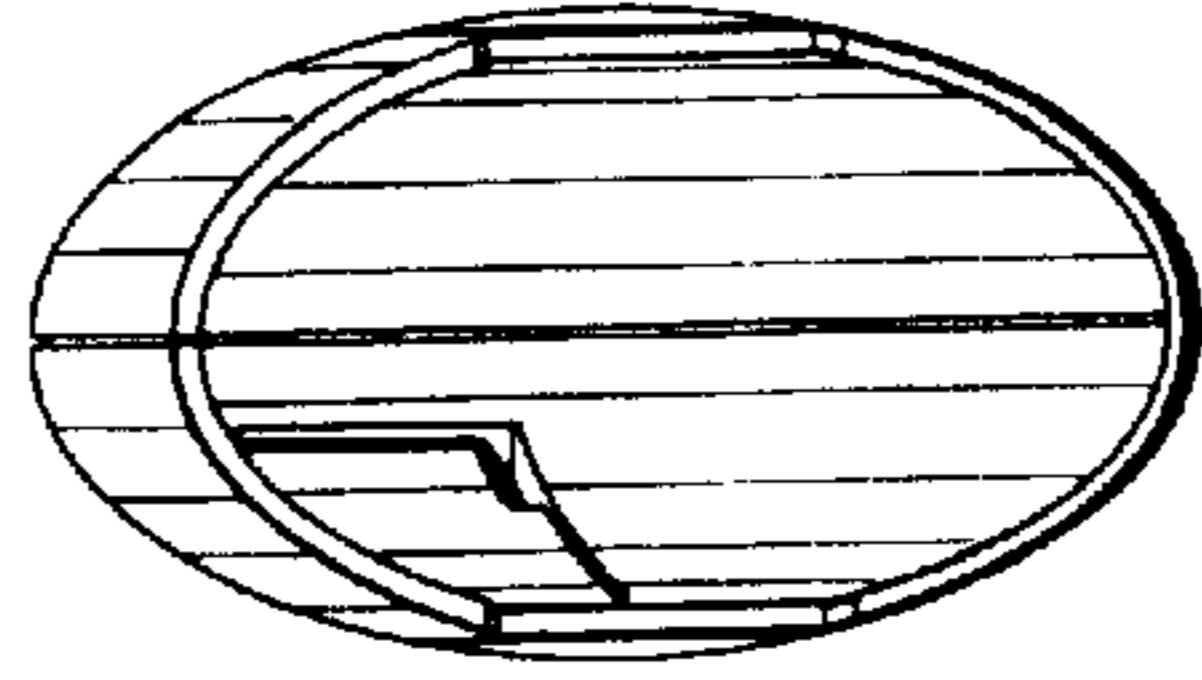

FIG. 13

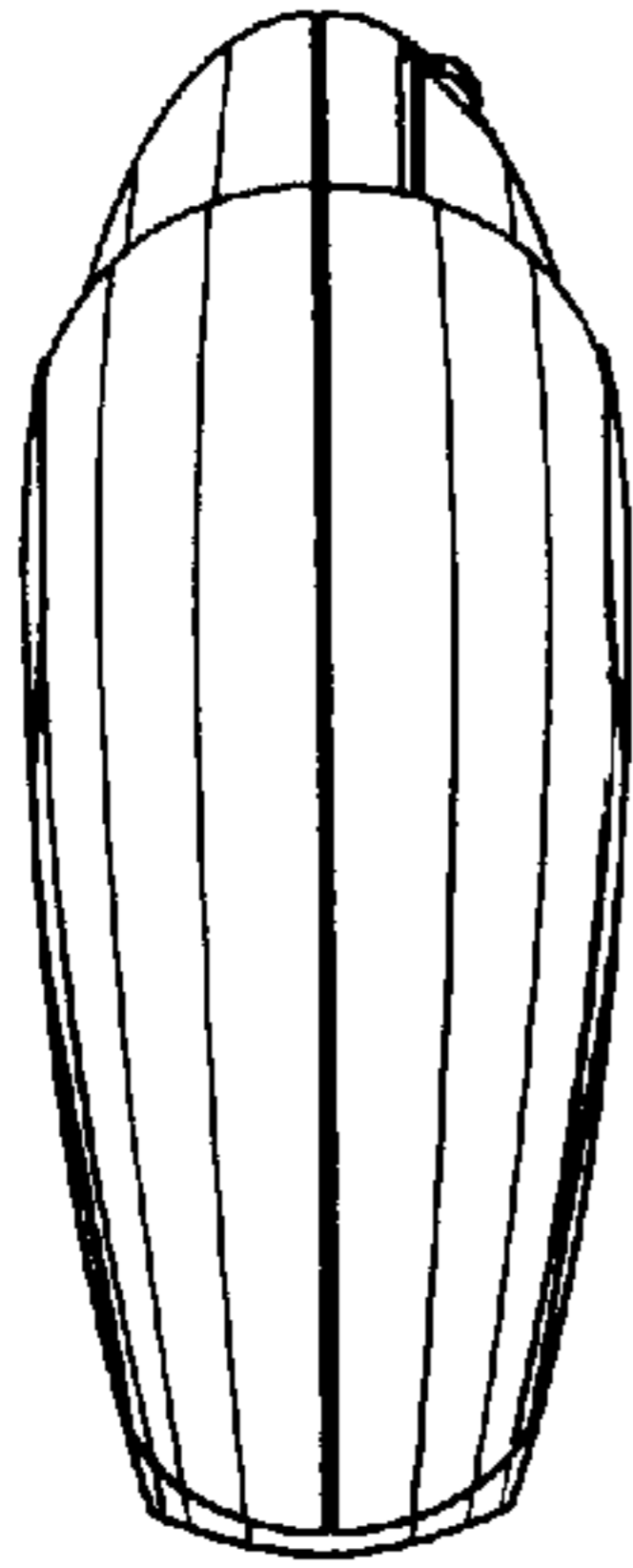

FIG. 10

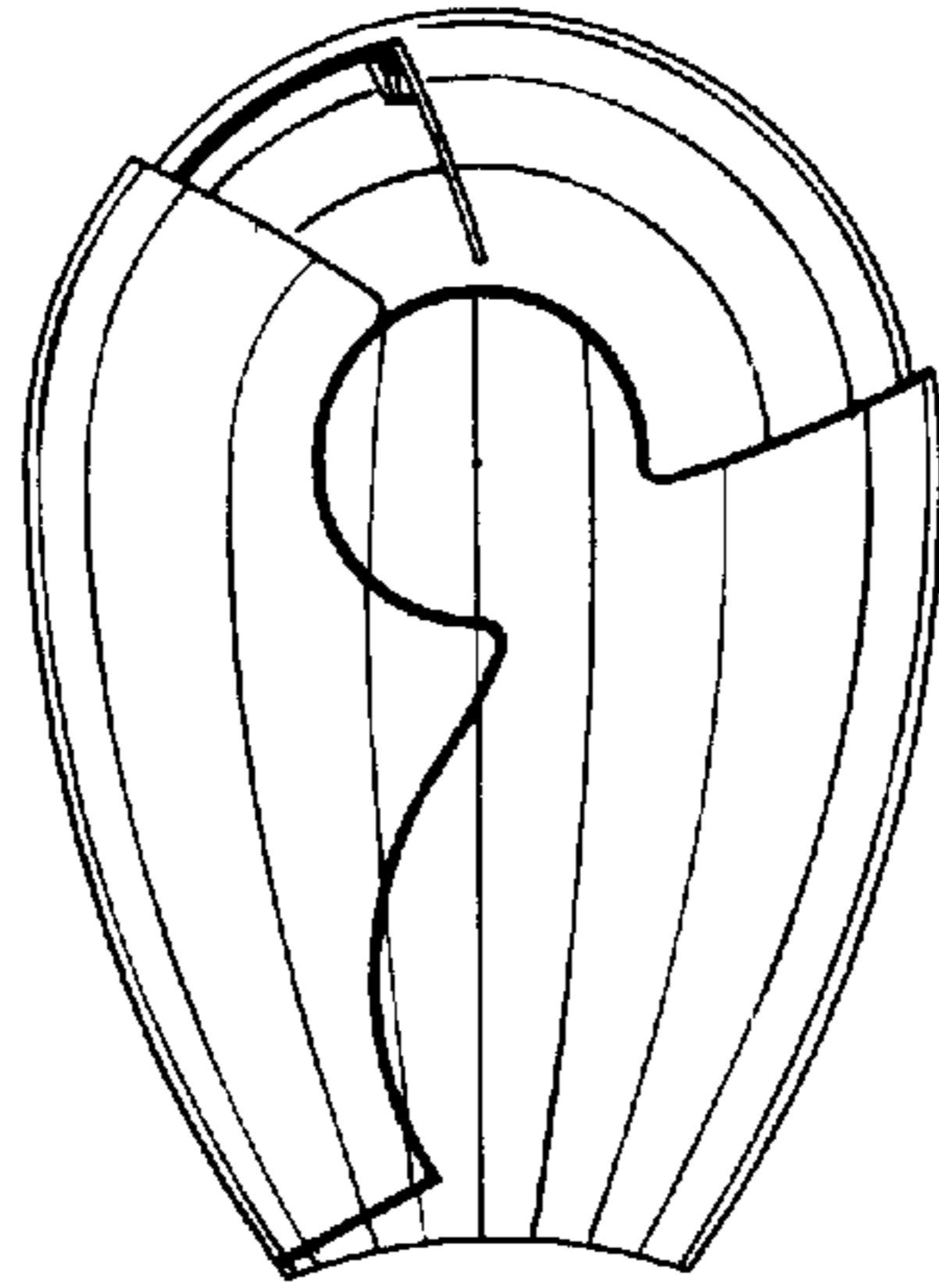

FIG. 7

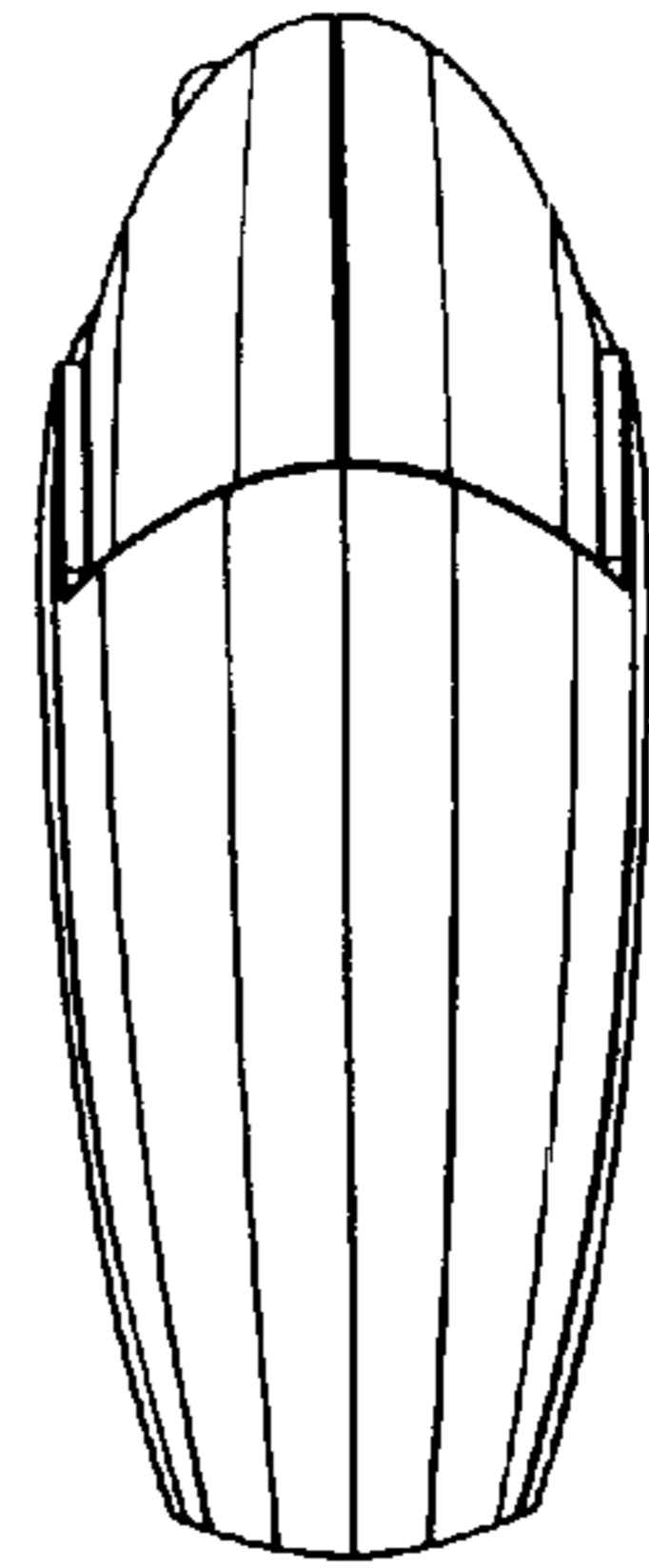

FIG. 15

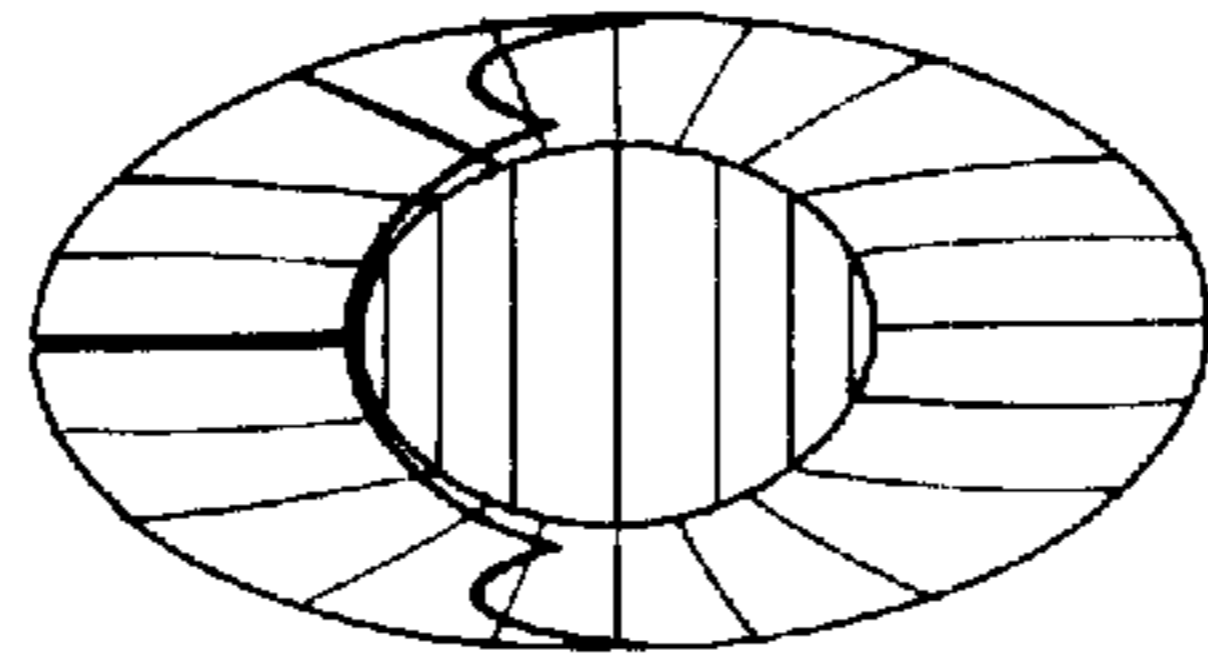

FIG. 11

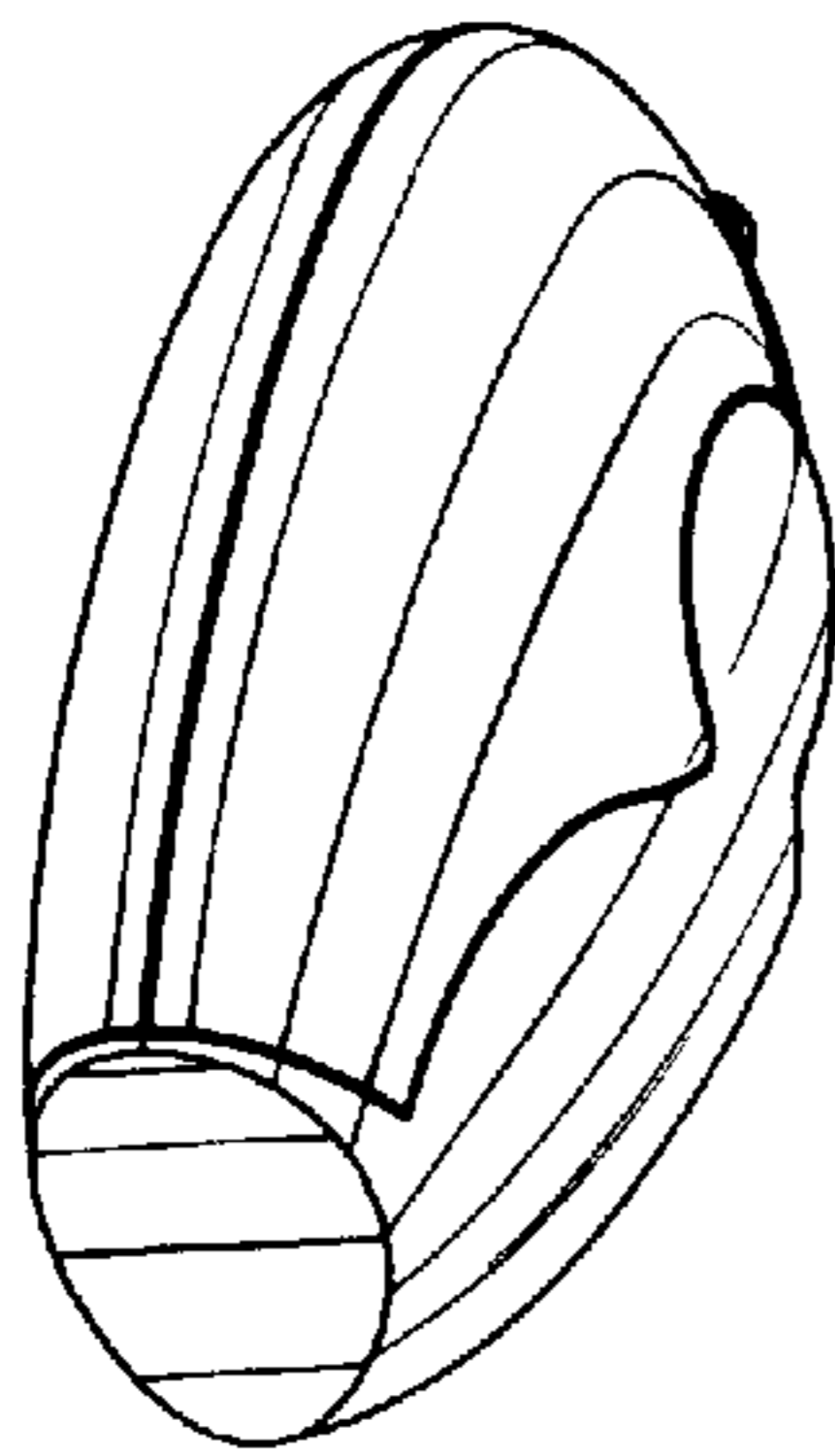

FIG. 1

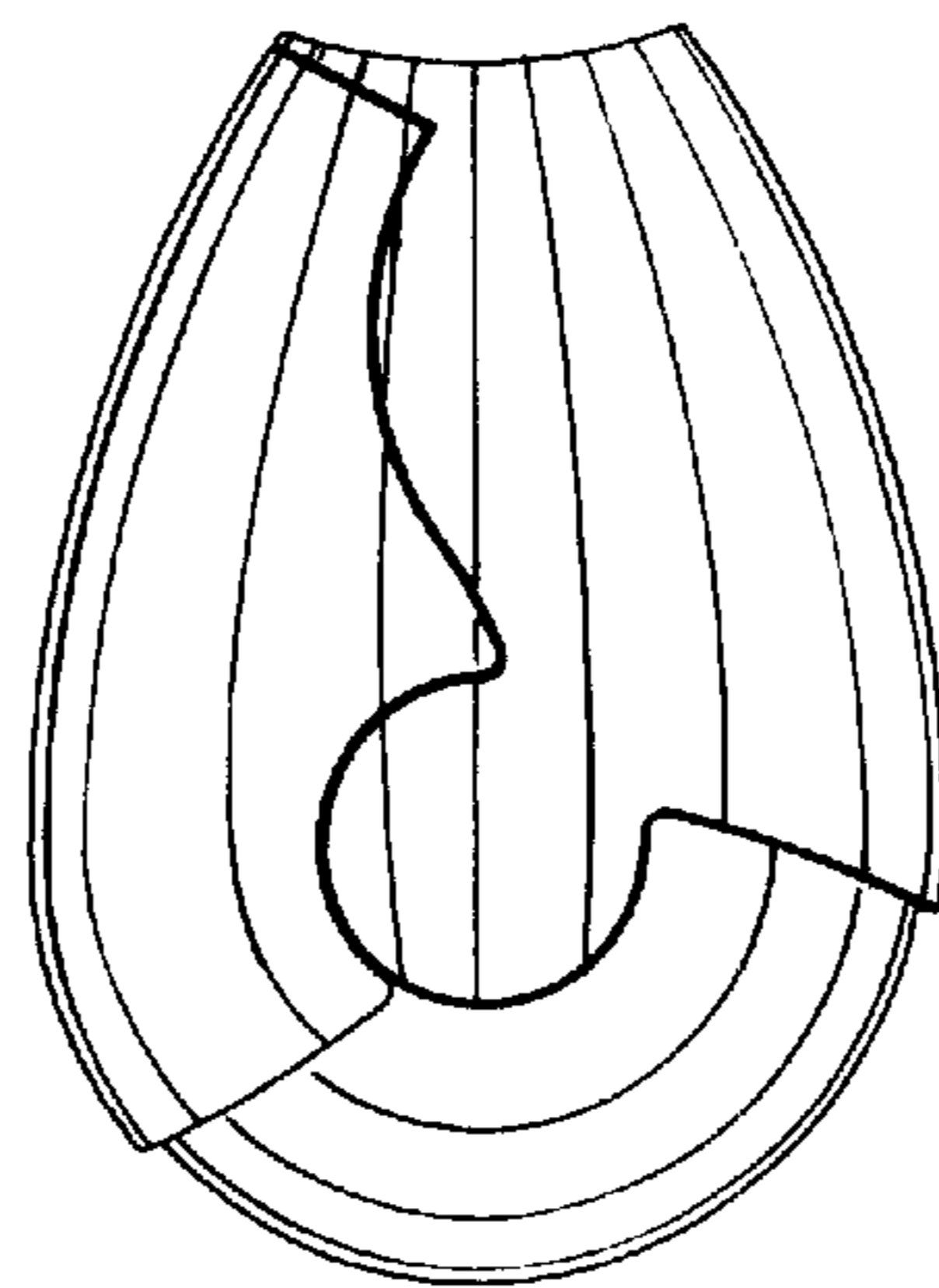

FIG. 5

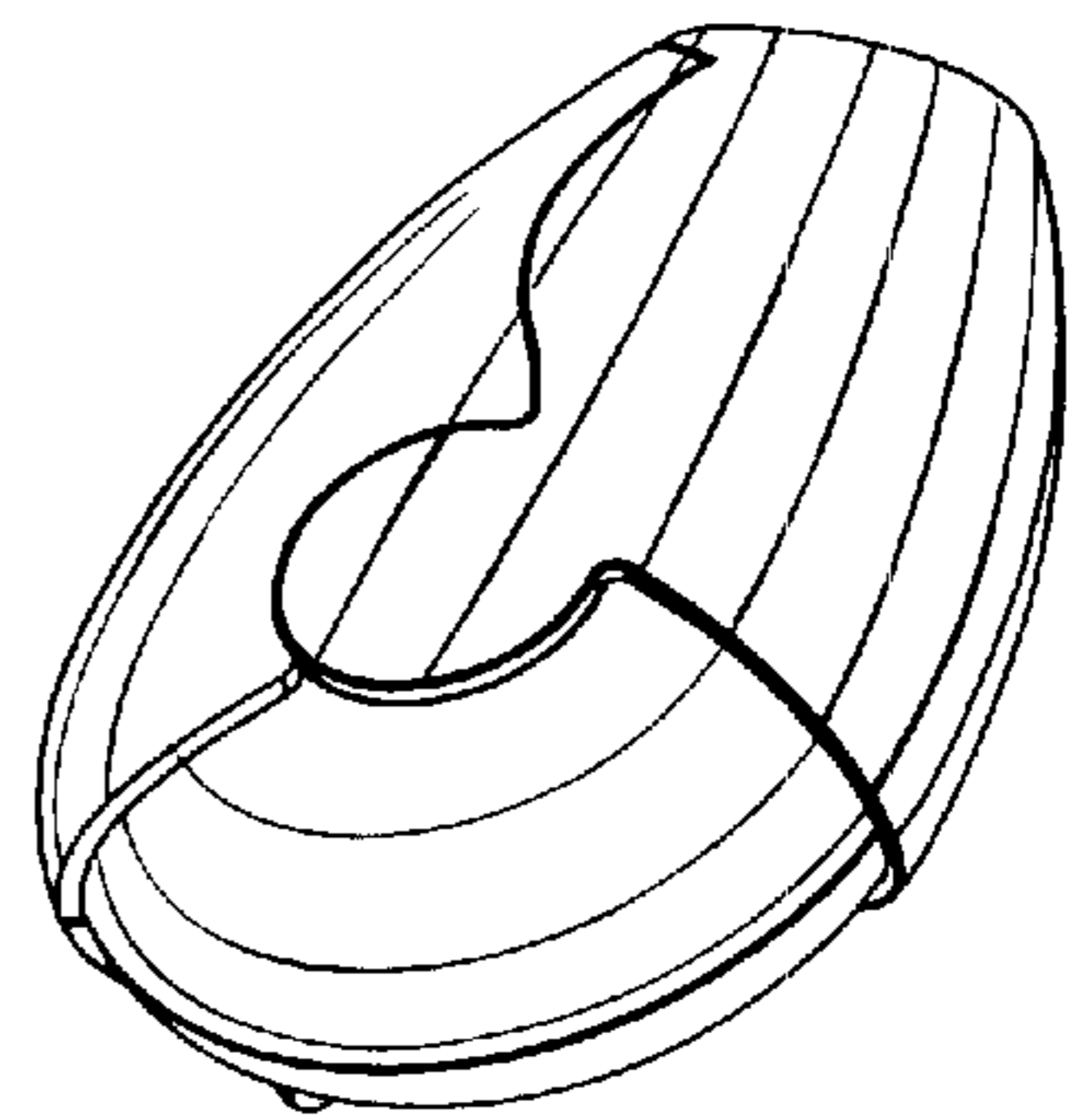

FIG. 3

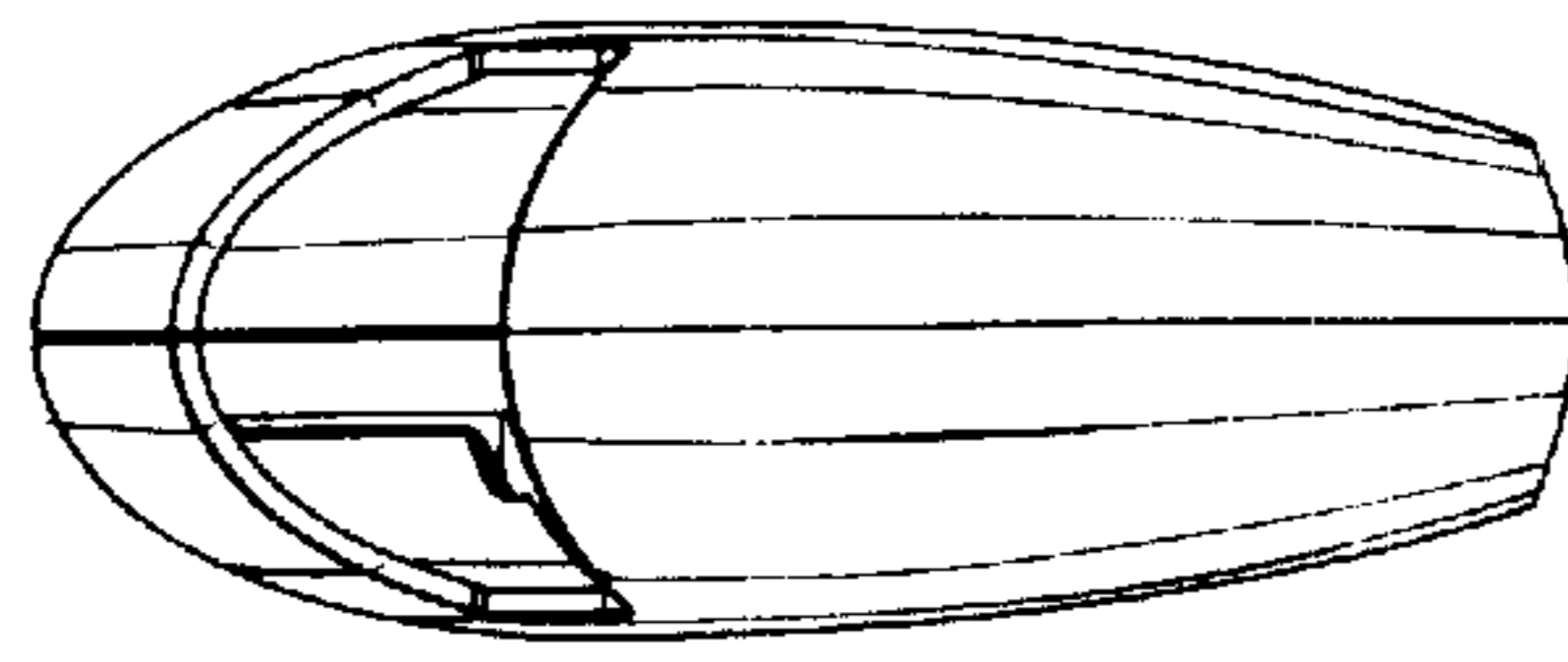

FIG. 14

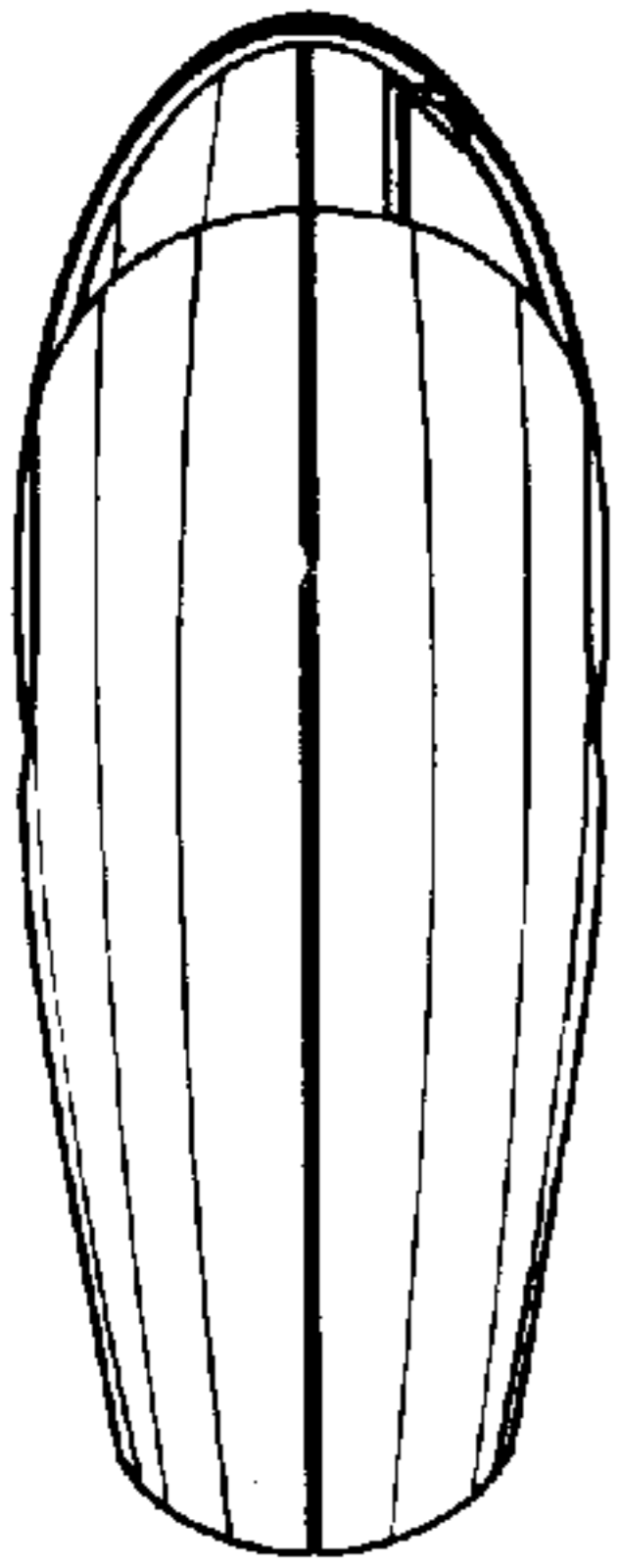

FIG. 9

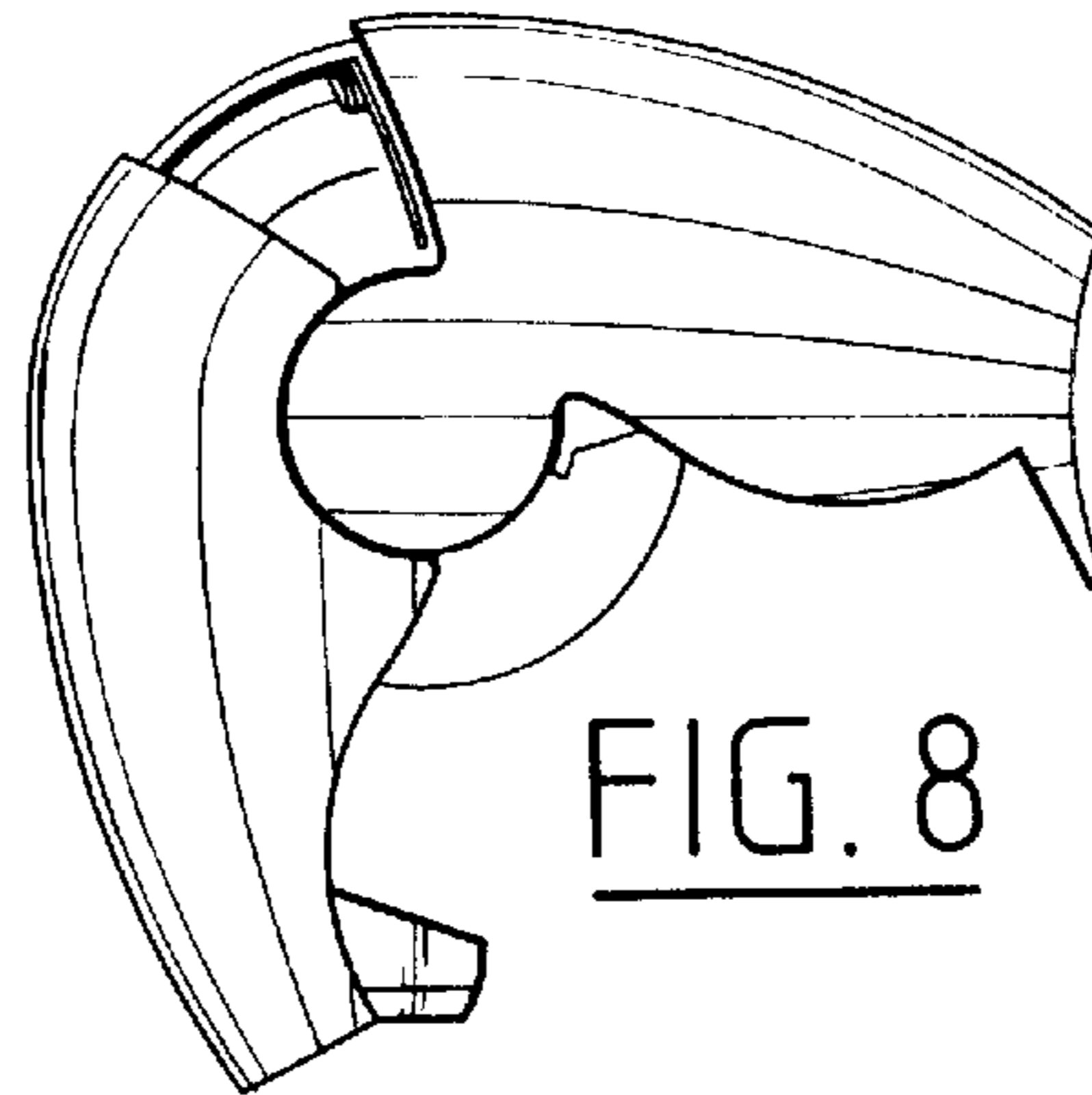

FIG. 8

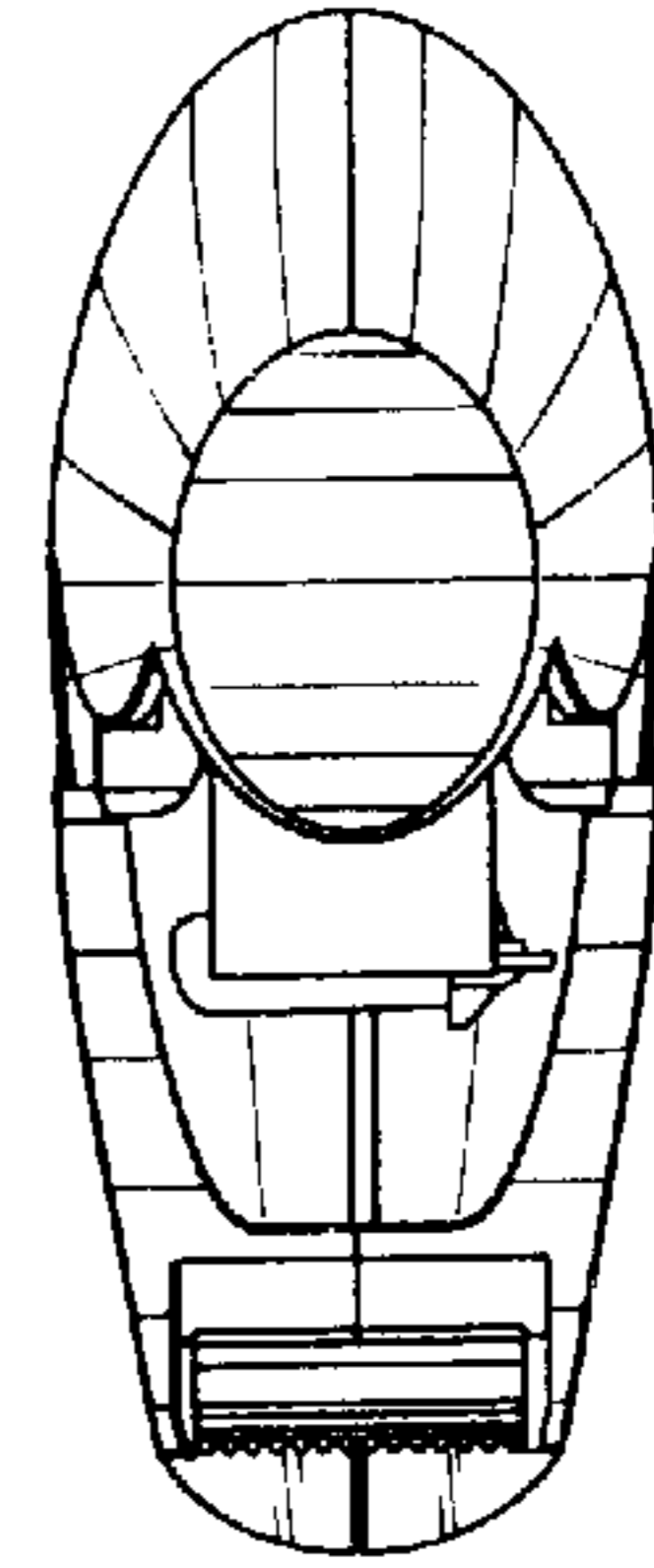

FIG. 16

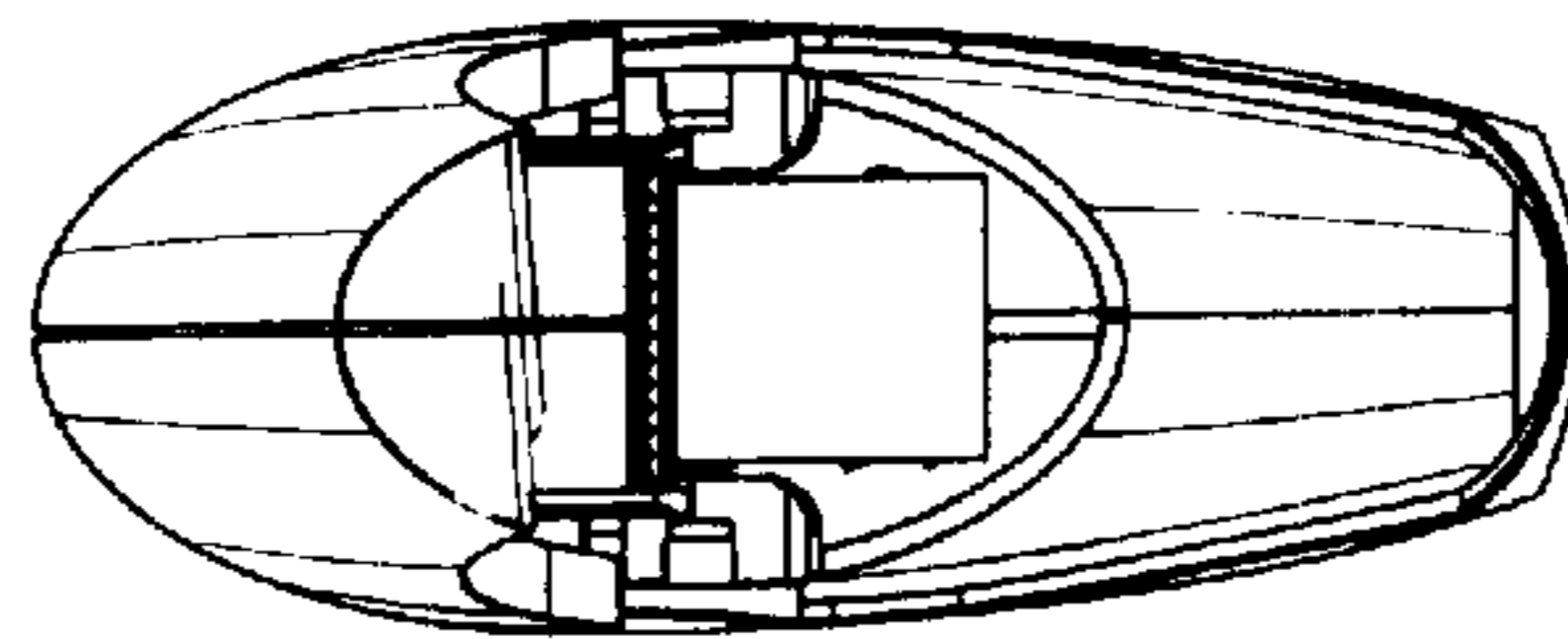

FIG. 12

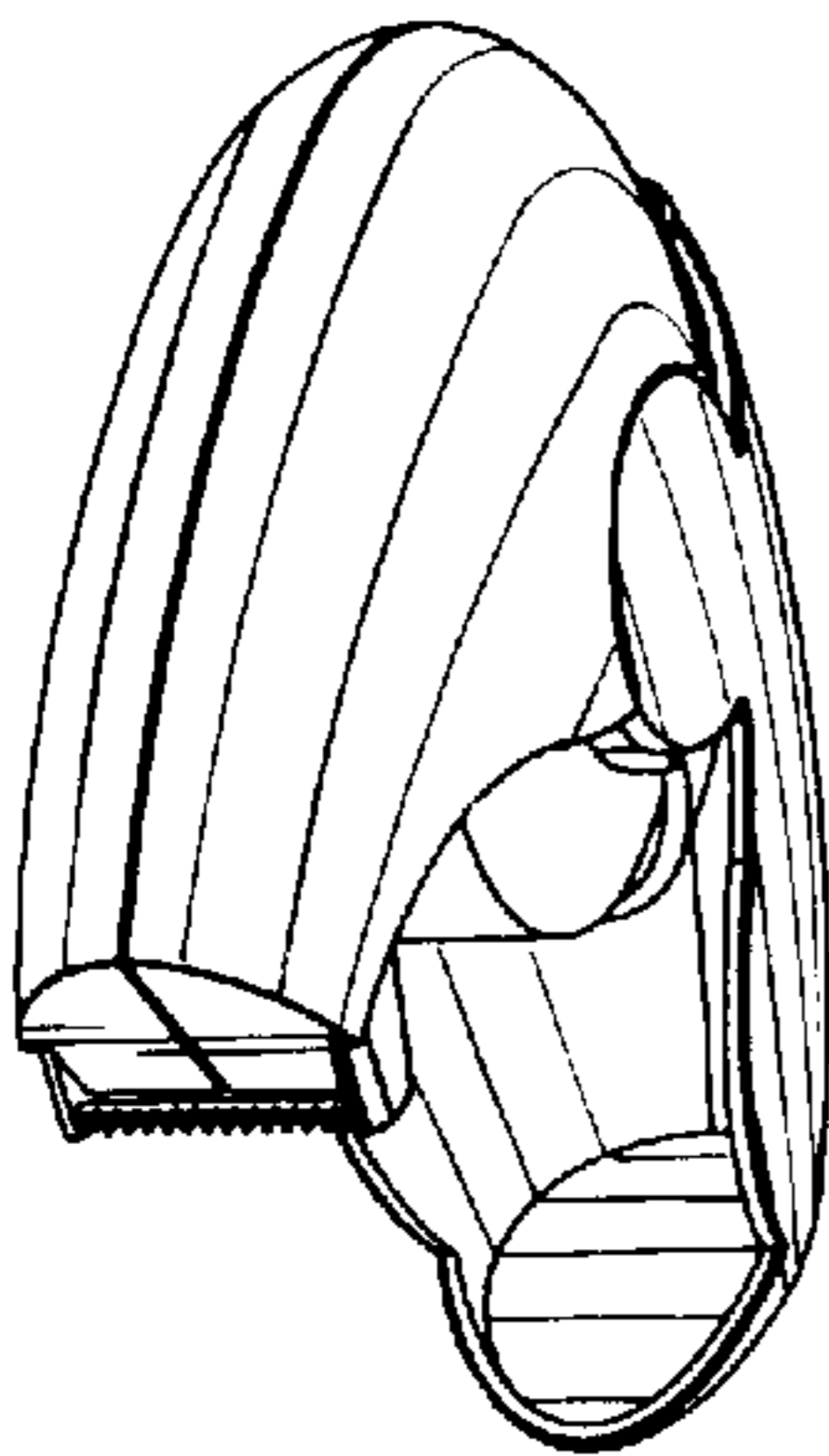

FIG. 2

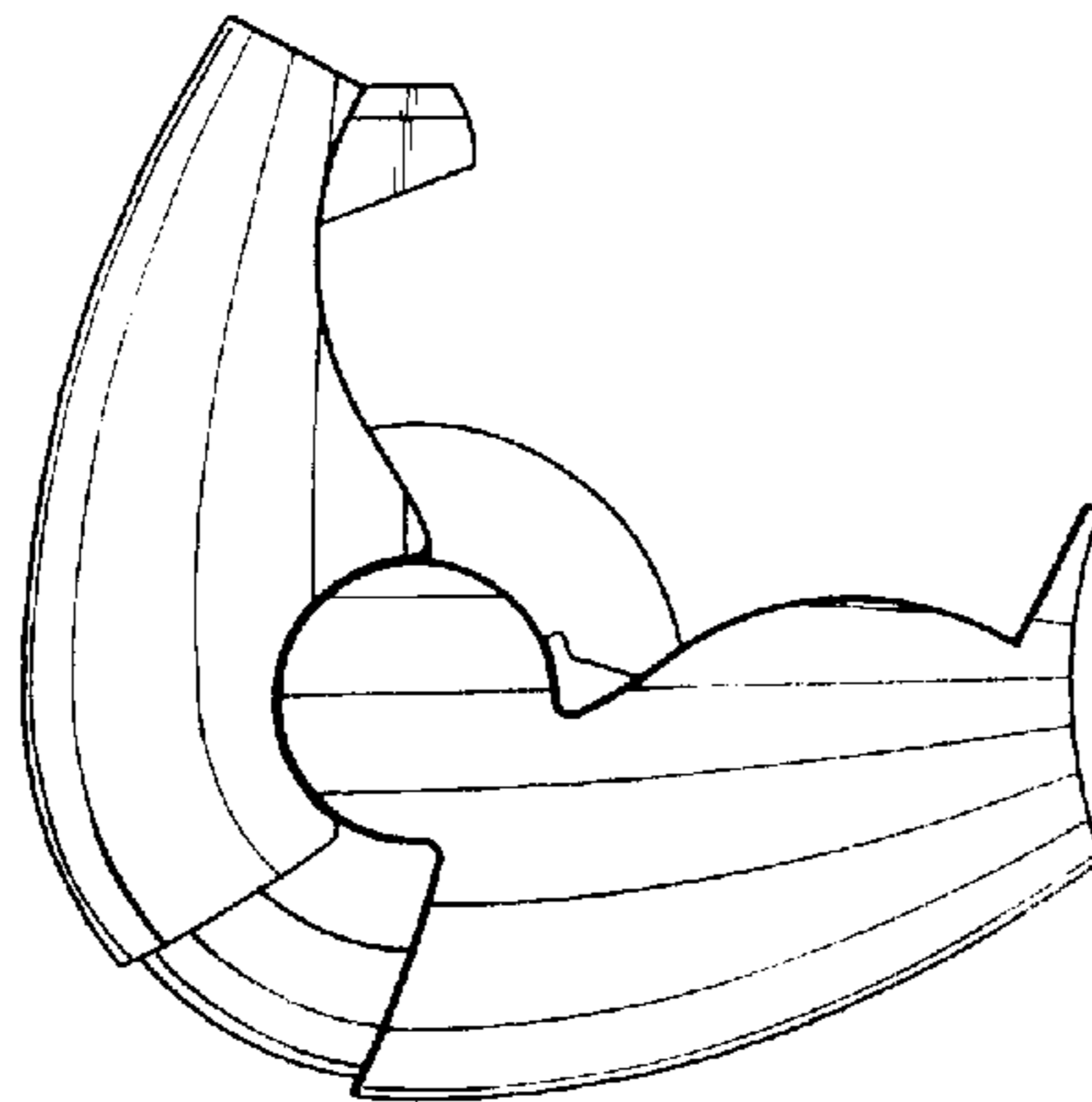

FIG. 6

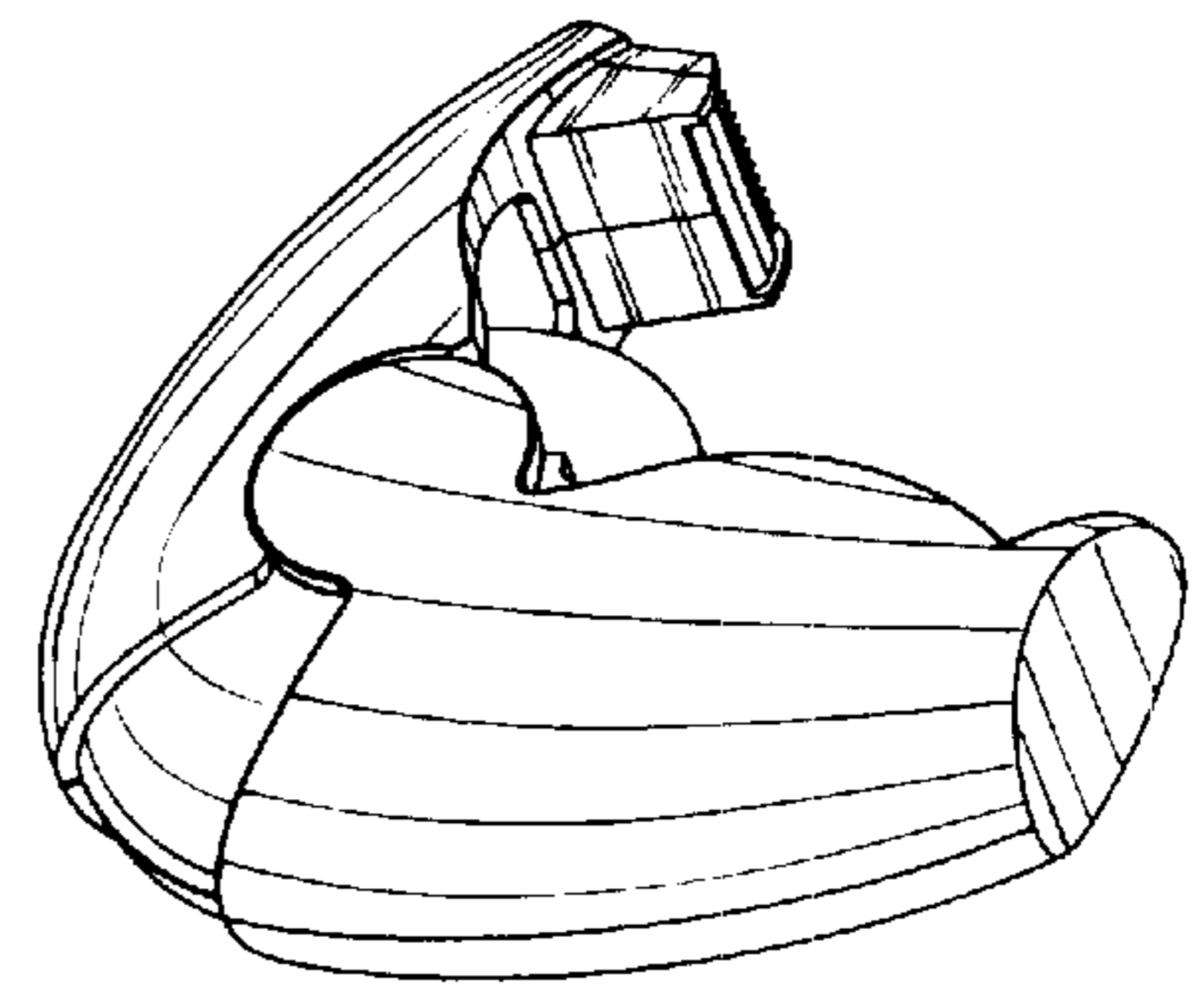

FIG. 4