



US00D475524S

(12) **United States Design Patent**
Clarke

(10) **Patent No.:** **US D475,524 S**

(45) **Date of Patent:** **** Jun. 10, 2003**

(54) **UMBRELLA CANOPY**

6,196,241 B1 * 3/2001 Doolan 135/16

(75) Inventor: **Dougan H. Clarke**, Miami Beach, FL (US)

* cited by examiner

(73) Assignee: **Tucci Engineering & Design, Inc.**, Miami, FL (US)

Primary Examiner—Louis S. Zarfes
Assistant Examiner—Robert A. Delehanty
(74) *Attorney, Agent, or Firm*—Malloy & Malloy, P.A.

(**) Term: **14 Years**

(57) **CLAIM**

(21) Appl. No.: **29/153,830**

The ornamental design for an umbrella canopy, as shown and described.

(22) Filed: **Jan. 11, 2002**

DESCRIPTION

(51) **LOC (7) Cl.** **03-03**

(52) **U.S. Cl.** **D3/5**

(58) **Field of Search** D3/5-6, 10-14, D3/16-17; 135/98, 16, 19.5, 20.1, 22-48, 910, 913; 362/102; 297/184.16

FIG. 1 is a perspective view of an umbrella canopy showing my new design the characteristic features of the design residing in eight (8) rib and strut members alternating in height, wherein the lengths of each rib also alternate between a longer and shorter length with an umbrella stand and pole shown in broken lines and forming no part of the claimed design;

(56) **References Cited**

U.S. PATENT DOCUMENTS

D14,944 S	*	4/1884	Drown	D3/5
D47,559 S	*	7/1915	Henderson	D3/5
D56,043 S	*	8/1920	Weinberg et al.	D3/5
D186,009 S	*	8/1959	Lorincz	D3/5
3,252,469 A	*	5/1966	Peake	135/25.31
4,347,862 A	*	9/1982	Secon	135/20.1
D273,346 S	*	4/1984	Secon	D3/5
D373,465 S	*	9/1996	Chipman	D3/5
5,909,746 A	*	6/1999	Doster et al.	135/25.1
D422,784 S	*	4/2000	Au	D3/5

FIG. 2 is a front view of the umbrella canopy design shown in FIG. 1 according to my invention;

FIG. 3 is a left side view thereof;

FIG. 4 is a top view thereof;

FIG. 5 is a right side view thereof;

FIG. 6 is a bottom view thereof; and

FIG. 7 is a rear view thereof; and,

FIG. 8 is a side view taken at forty-five (45°) from the front view shown in FIG. 2.

1 Claim, 7 Drawing Sheets

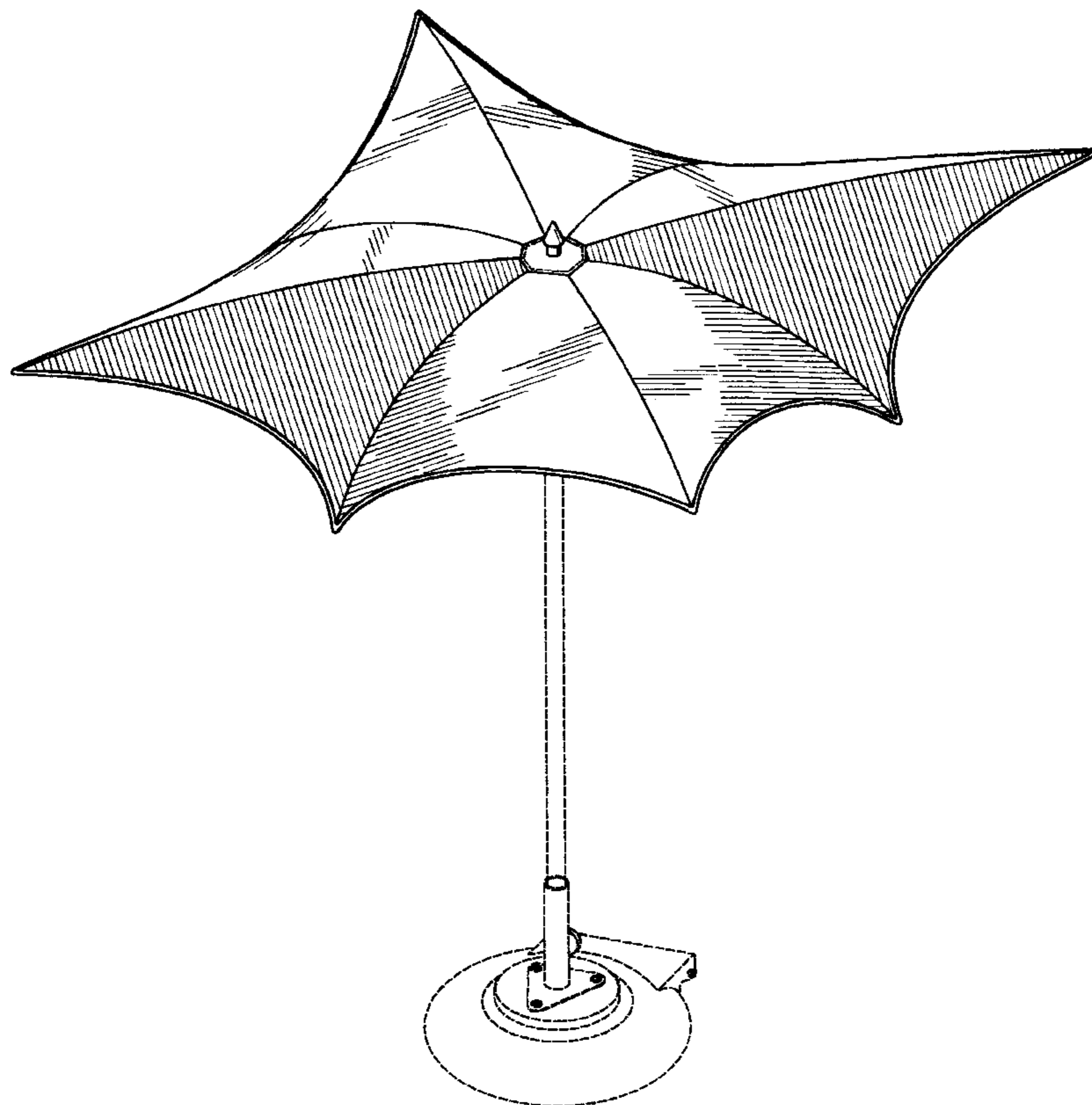

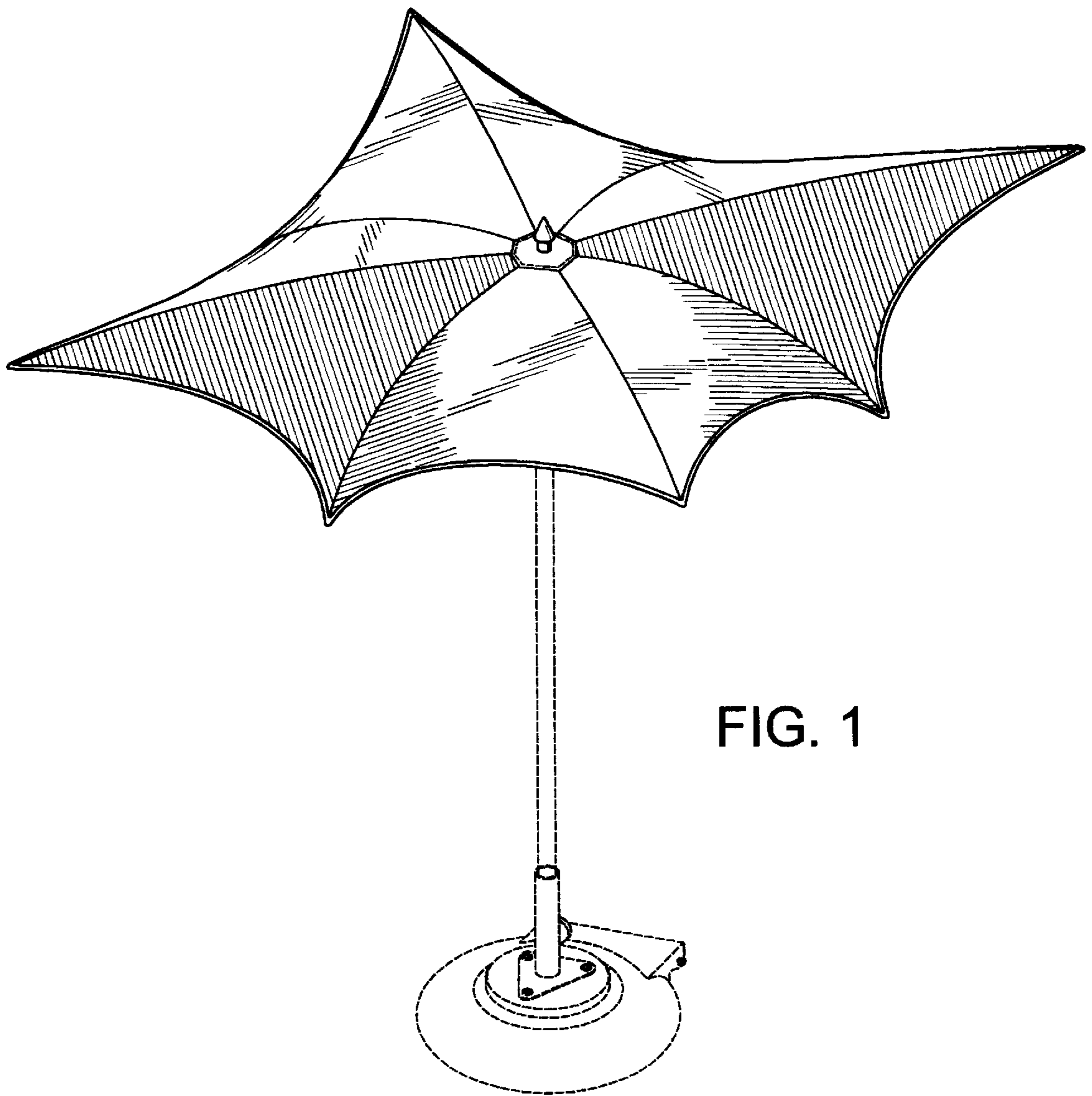

FIG. 1

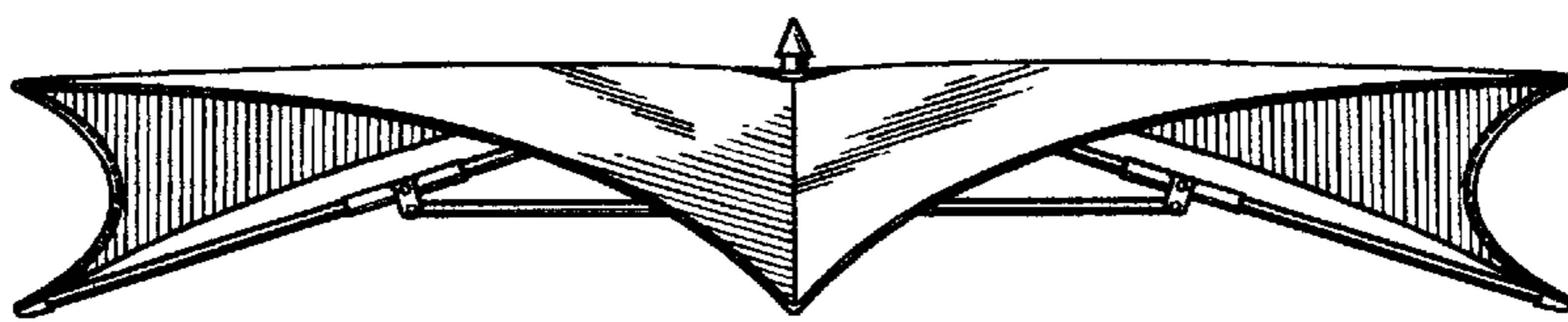

FIG. 7

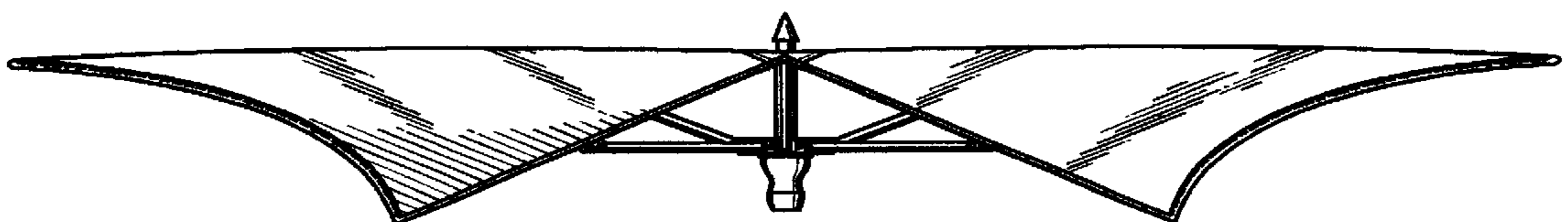

FIG. 8

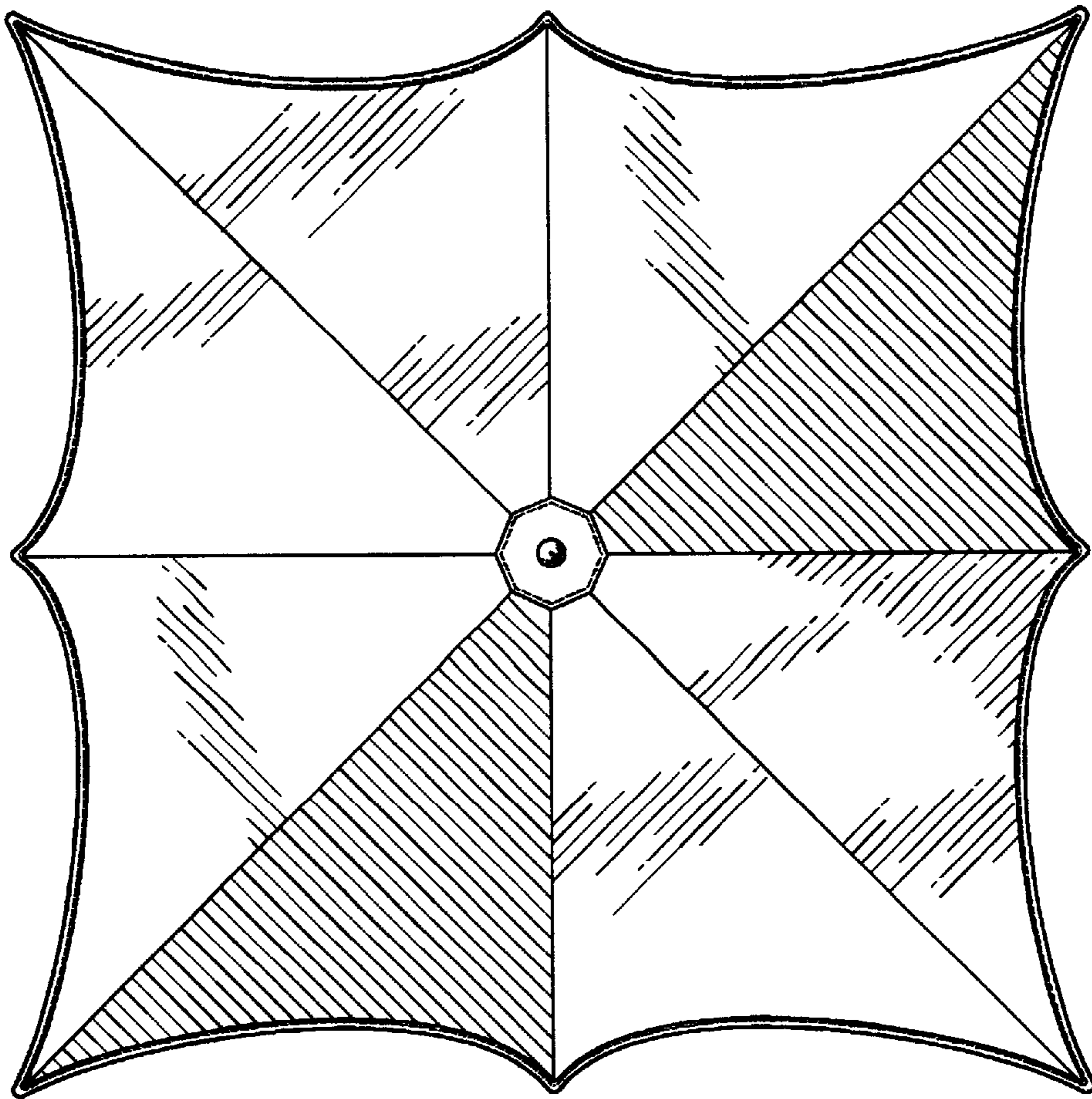

FIG. 4

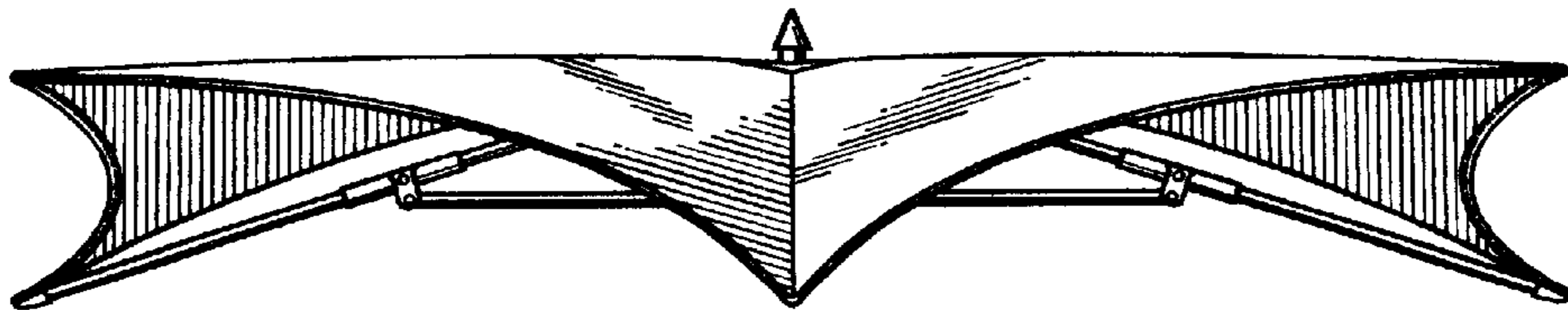

FIG. 2

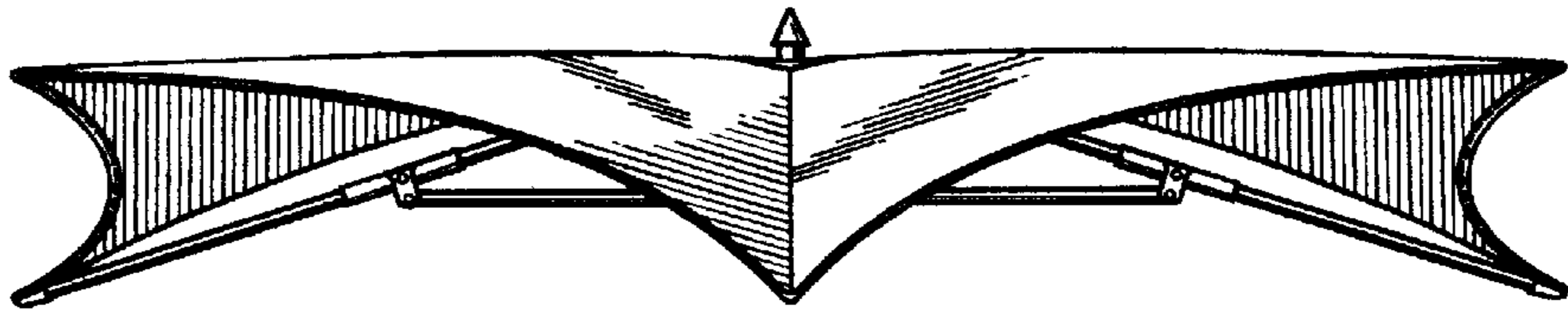

FIG. 3

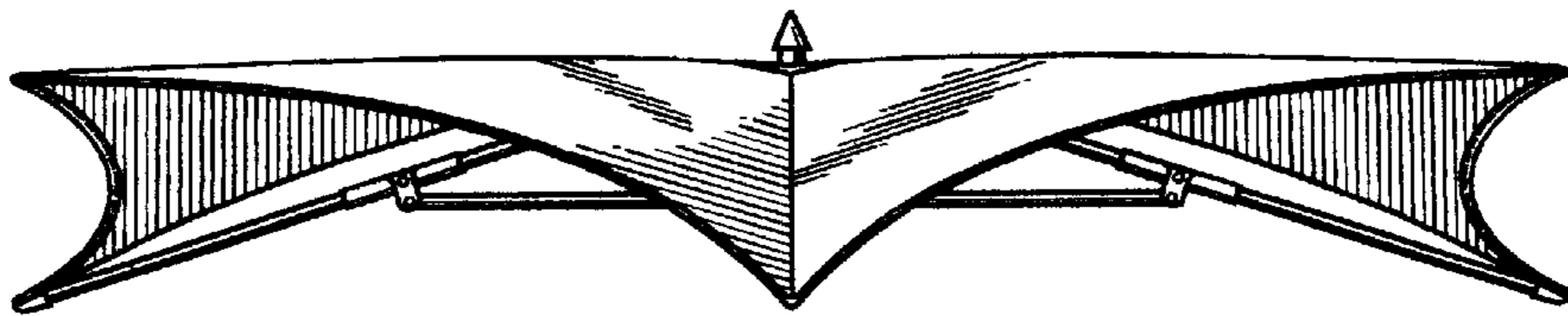

FIG. 5

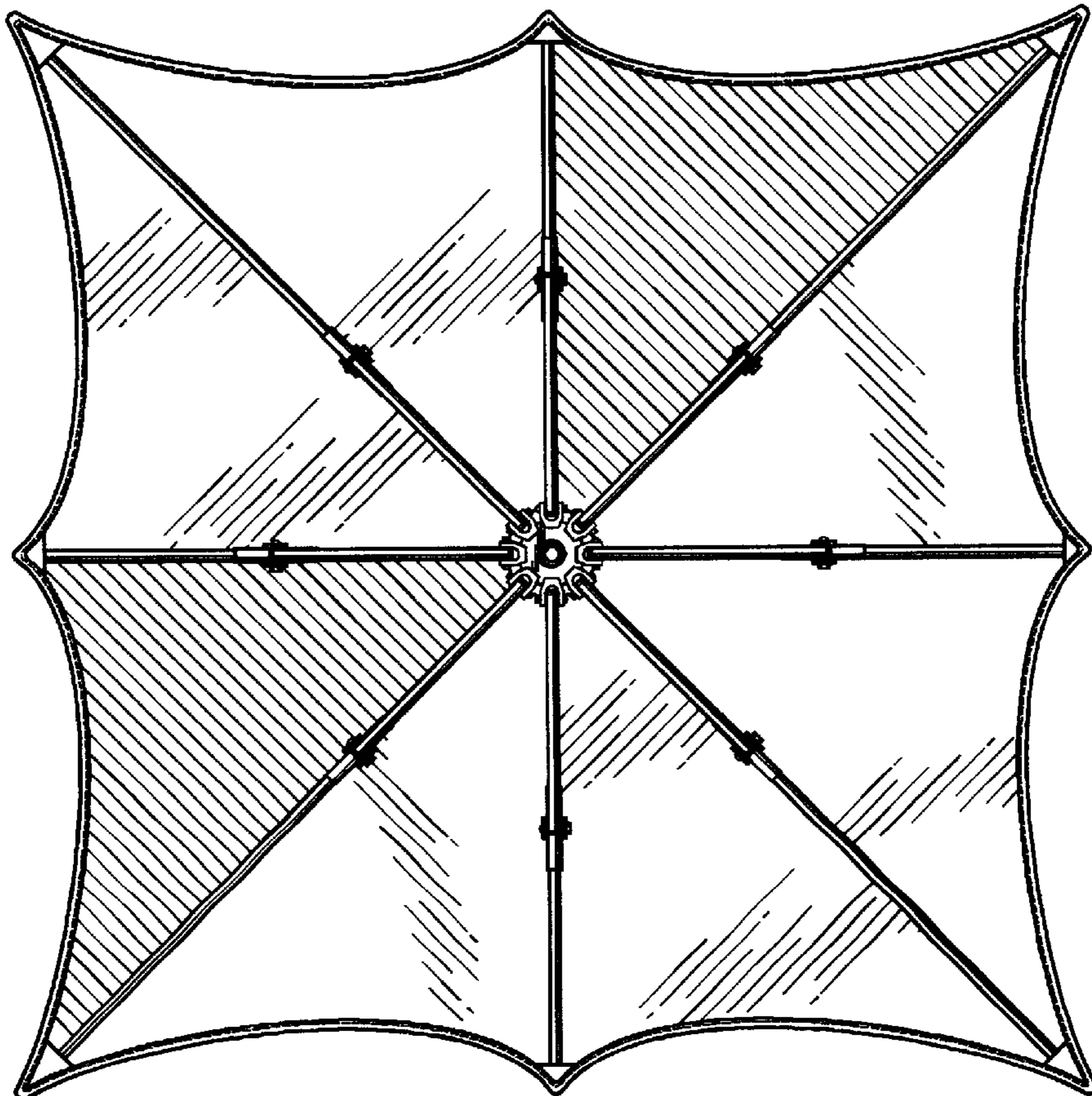

FIG. 6

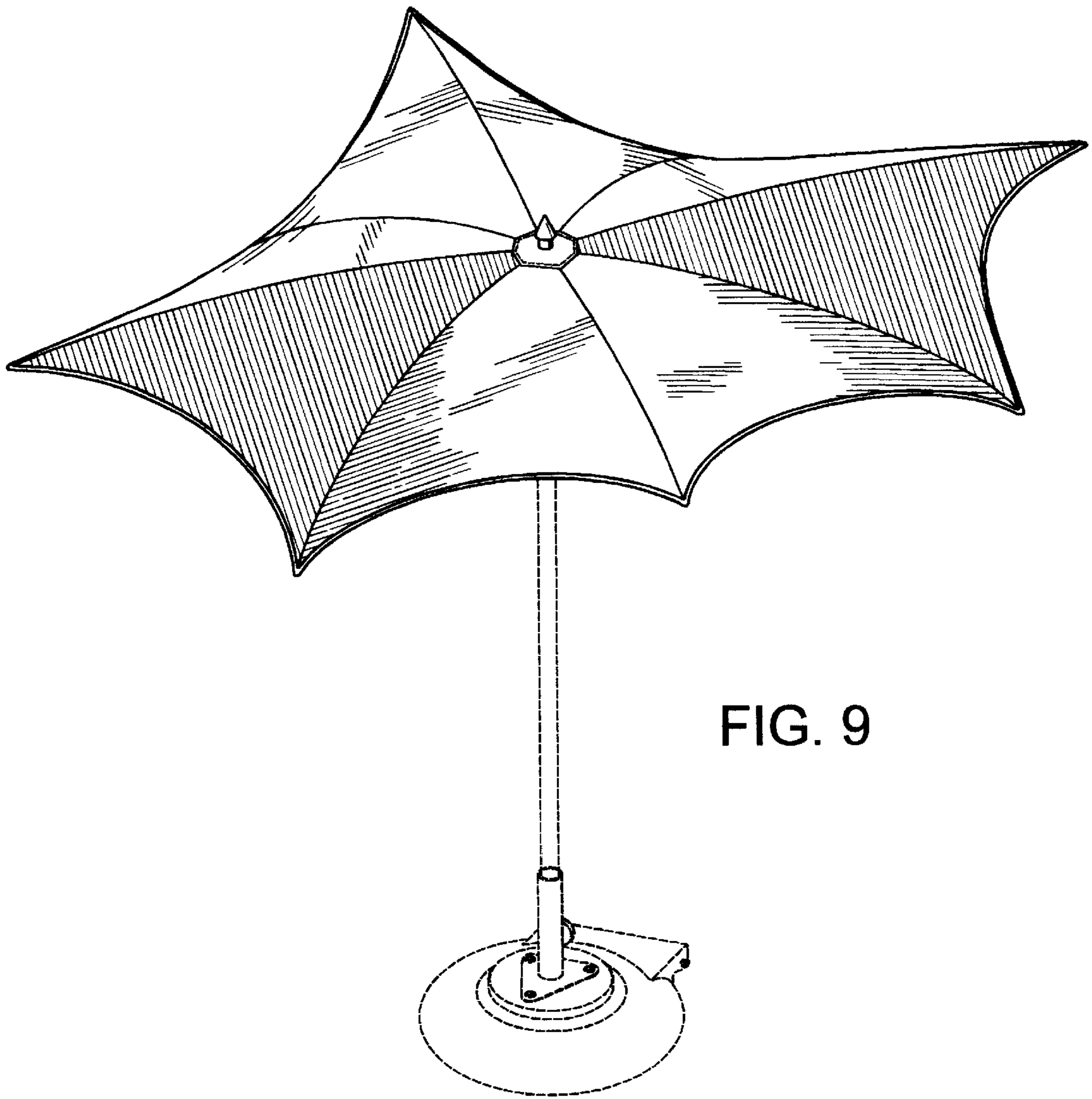

FIG. 9

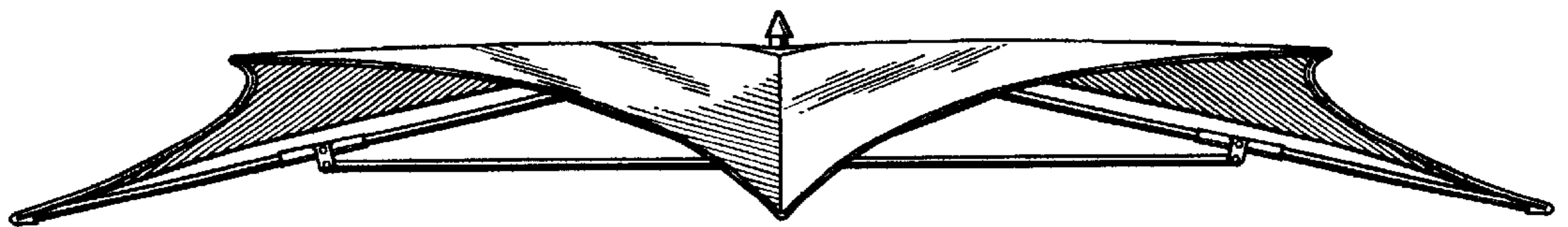

FIG. 15

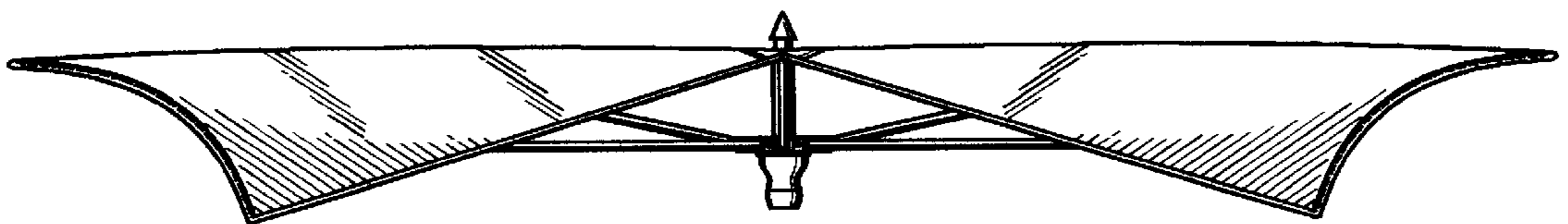

FIG. 16

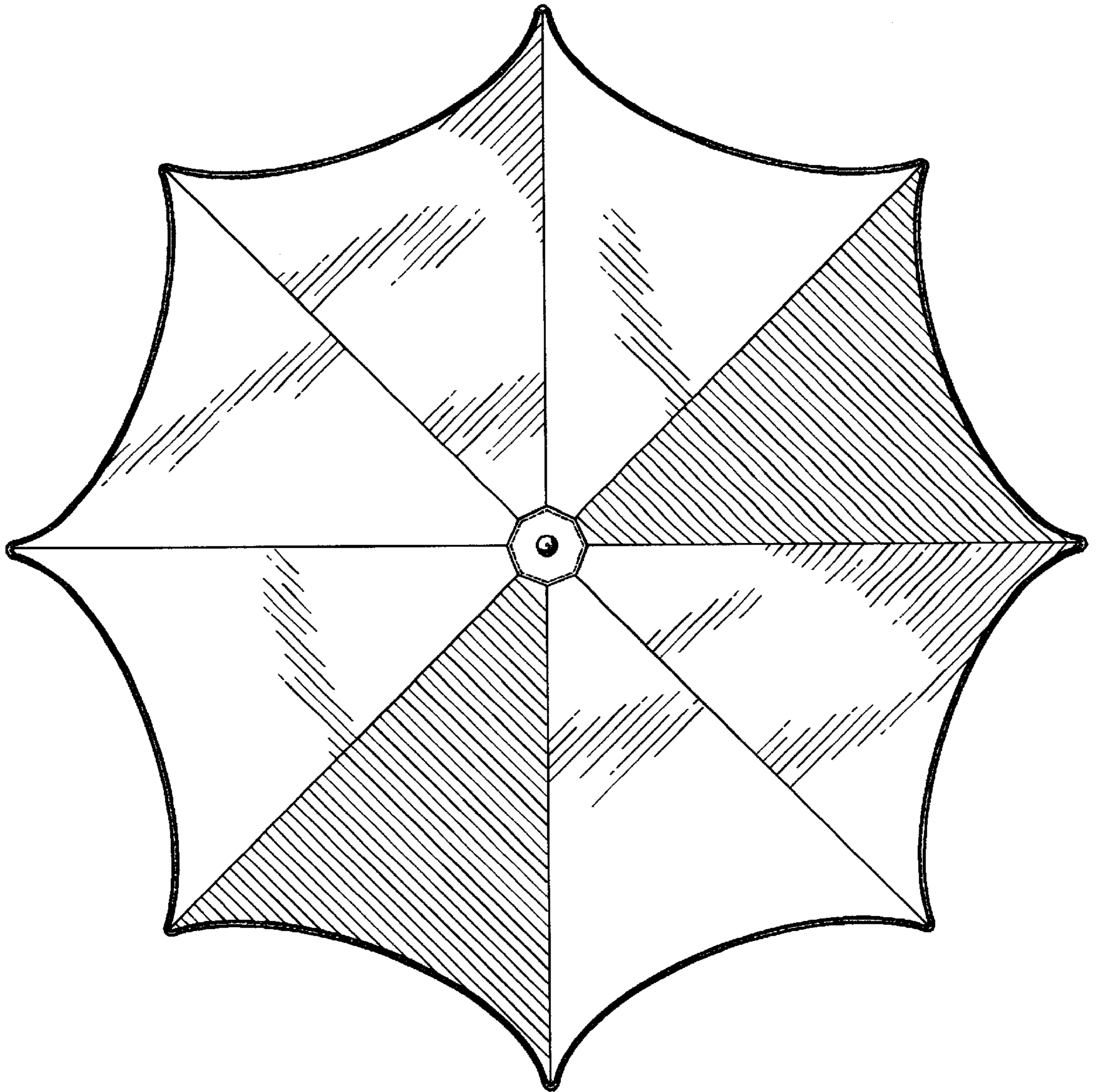

FIG. 12

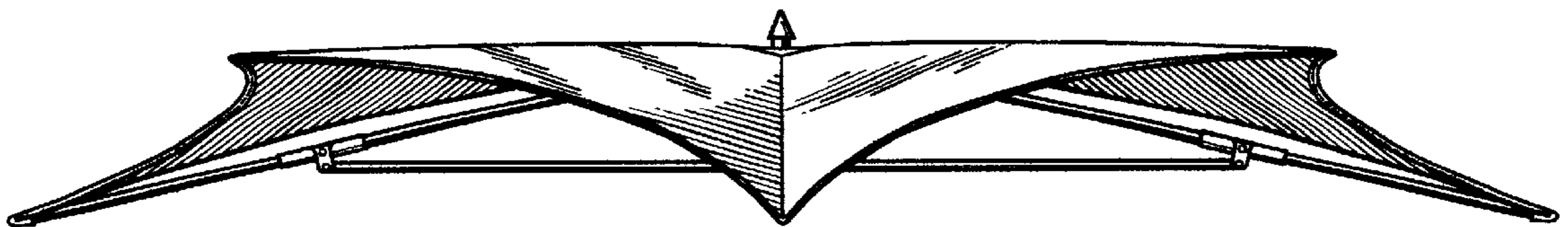

FIG. 10

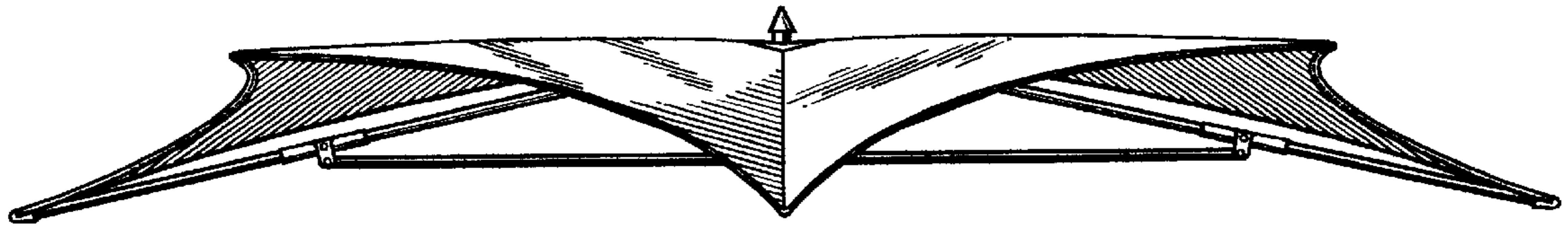

FIG. 11

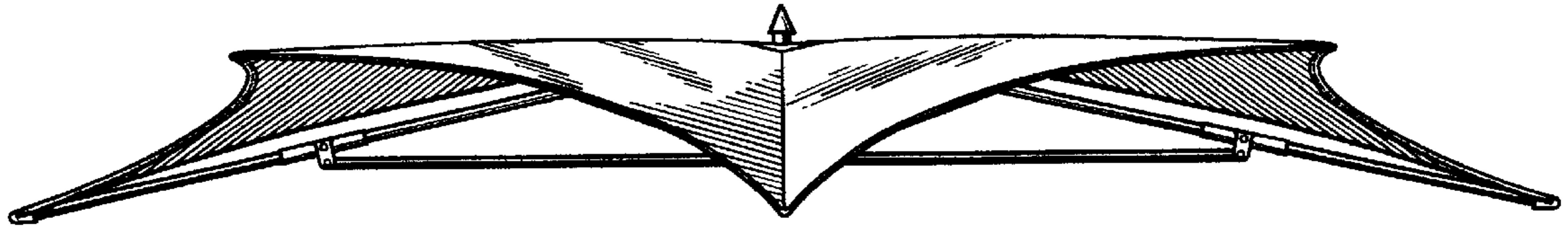

FIG. 13

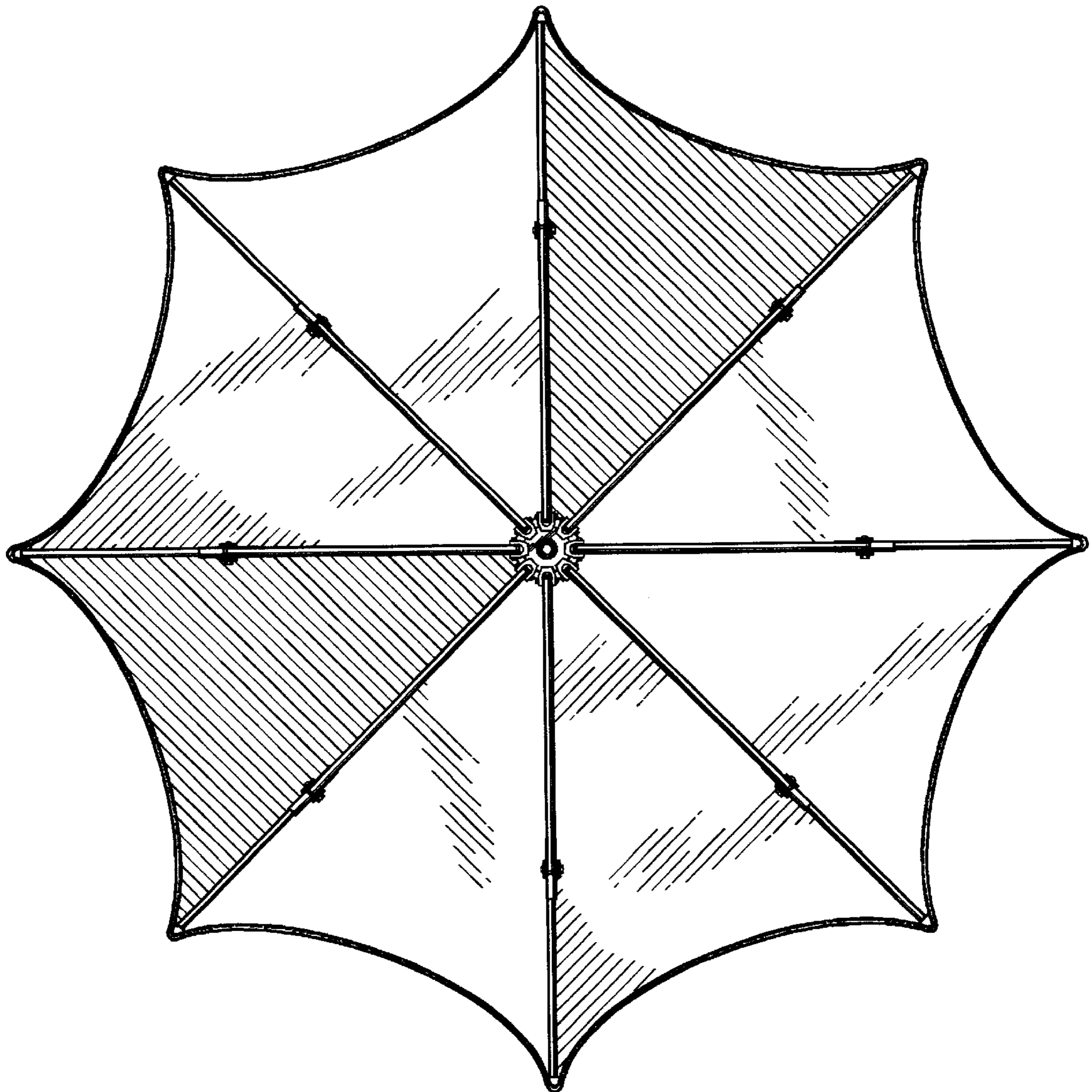

FIG. 14

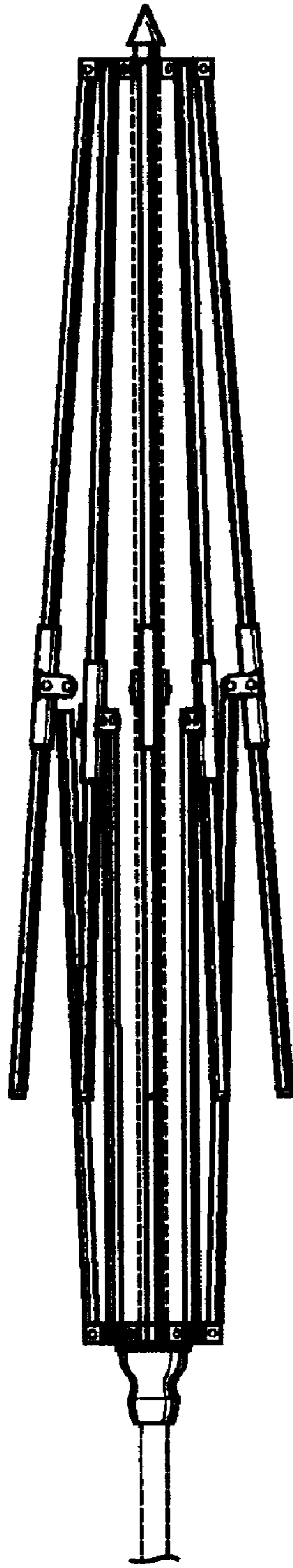

FIG. 17