



US00D475454S

(12) **United States Design Patent**
Gillespie, Jr. et al.

(10) **Patent No.:** **US D475,454 S**
(45) **Date of Patent:** **** Jun. 3, 2003**

(54) **INFUSION PUMP**

(75) Inventors: **John Gillespie, Jr.**, Libertyville, IL (US); **Michael Kenneth Platt**, Mt. Prospect, IL (US); **Jason Martin**, Portland, OR (US)

(73) Assignee: **Baxter International Inc.**, Deerfield, IL (US)

(**) Term: **14 Years**

(21) Appl. No.: **29/162,403**

(22) Filed: **Jun. 14, 2002**

(51) **LOC (7) Cl.** **24-02**

(52) **U.S. Cl.** **D24/111; D15/7**

(58) **Field of Search** D24/111, 108; D15/7, 8, 9; 604/66, 67, 65, 151, 153, 152, 138, 35, 30; 128/DIG. 13, DIG. 12

(56) **References Cited**

U.S. PATENT DOCUMENTS

D326,152 S * 5/1992 Rutter D24/111

D380,260 S 6/1997 Hyman D24/111
D390,654 S 2/1998 Alsberg et al. D24/111
5,782,805 A 7/1998 Meinzer et al. 604/131
D469,176 S * 1/2003 Hall et al. D24/111

* cited by examiner

Primary Examiner—Ian Simmons

(74) *Attorney, Agent, or Firm*—Wallenstein & Wagner; Paul J. Nykaza

(57) **CLAIM**

The ornamental design for an infusion pump, as shown and described.

DESCRIPTION

FIG. 1 is a front perspective view of an infusion pump showing my new design.

FIG. 2 is a front elevation view thereof.

FIG. 3 is a rear elevation view thereof.

FIG. 4 is a left side elevation view thereof.

FIG. 5 is a right side elevation view thereof.

FIG. 6 is a top plan view thereof; and,

FIG. 7 is a bottom plan view thereof.

1 Claim, 3 Drawing Sheets

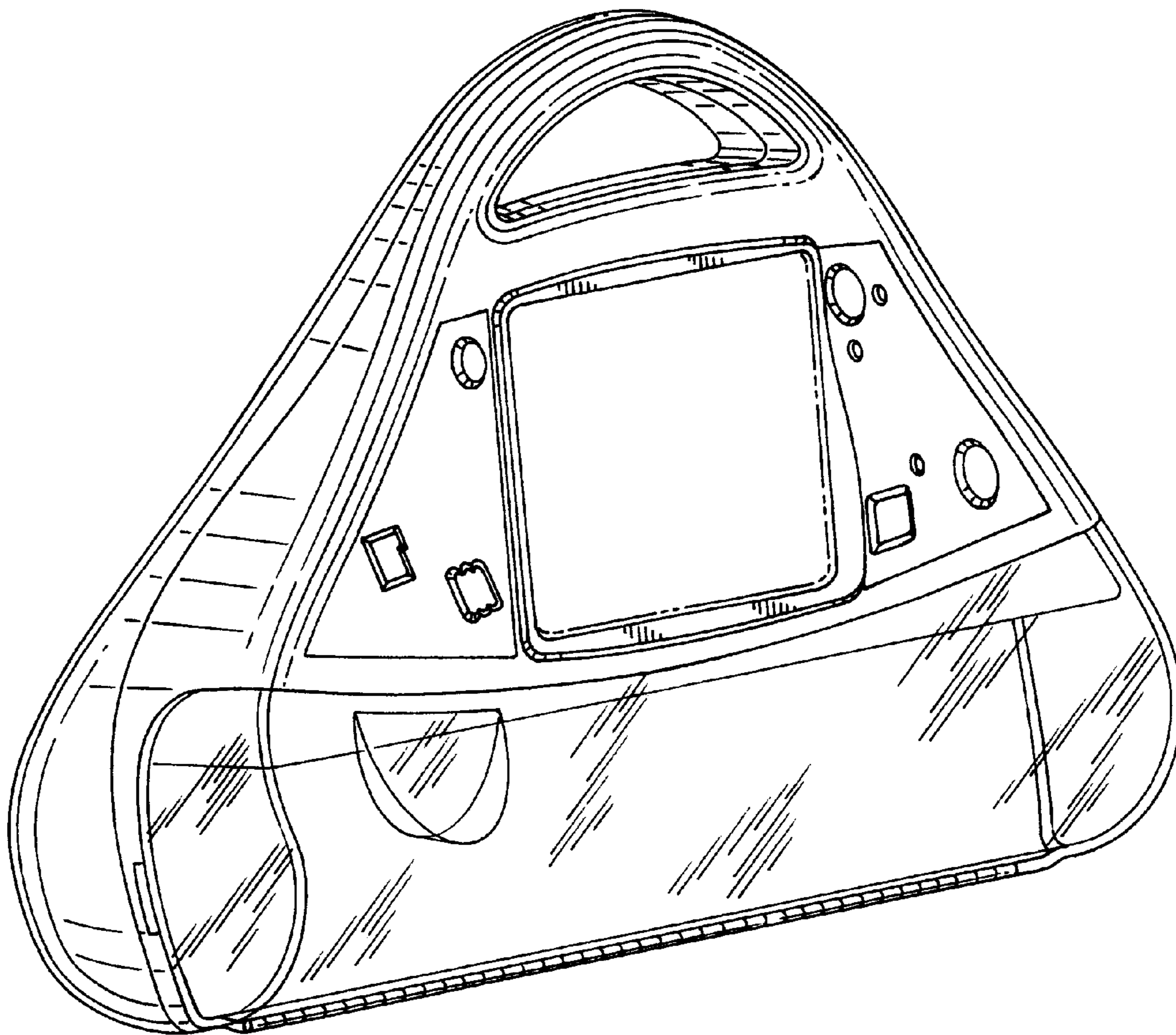

FIG. 1

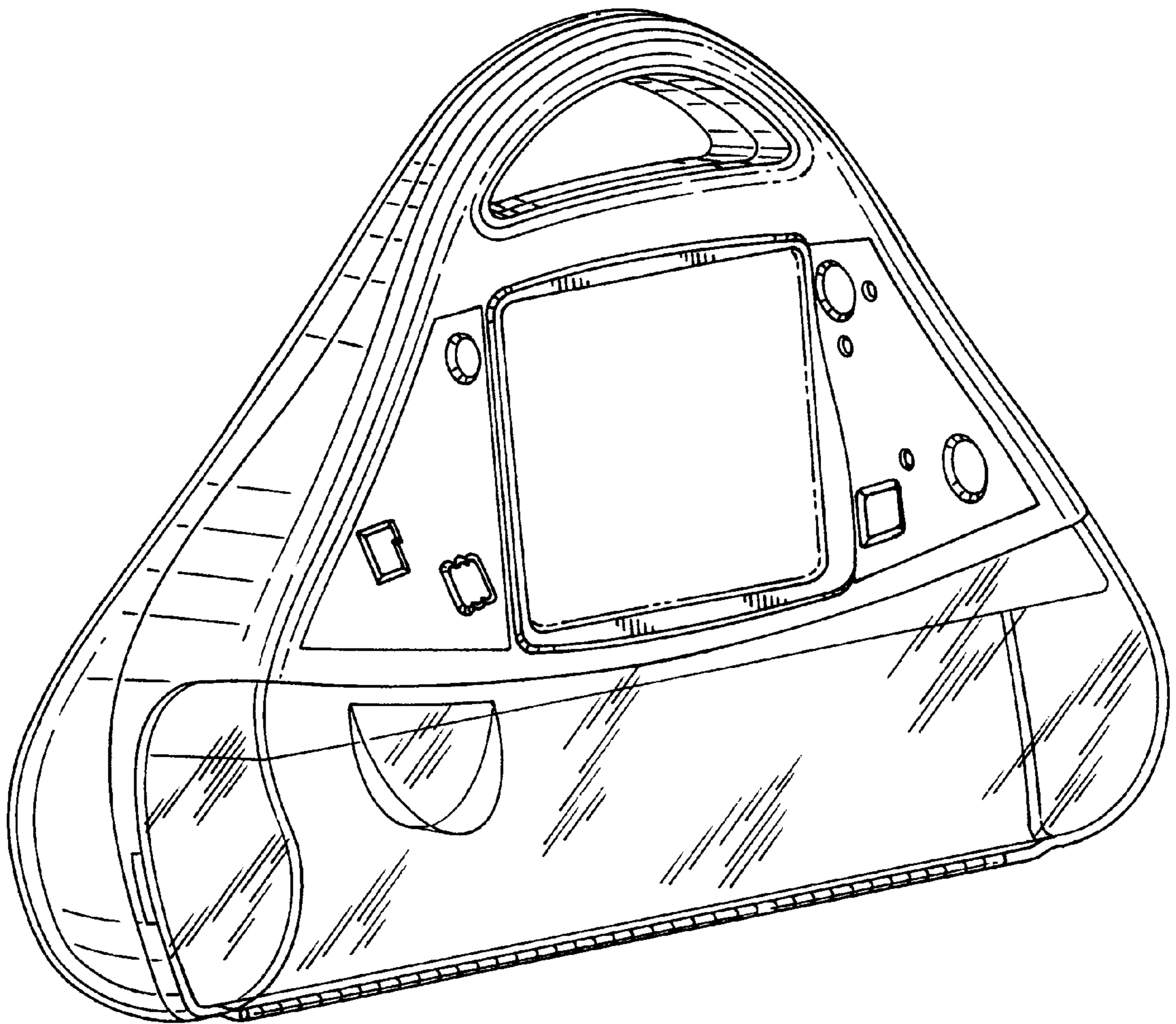

FIG. 2

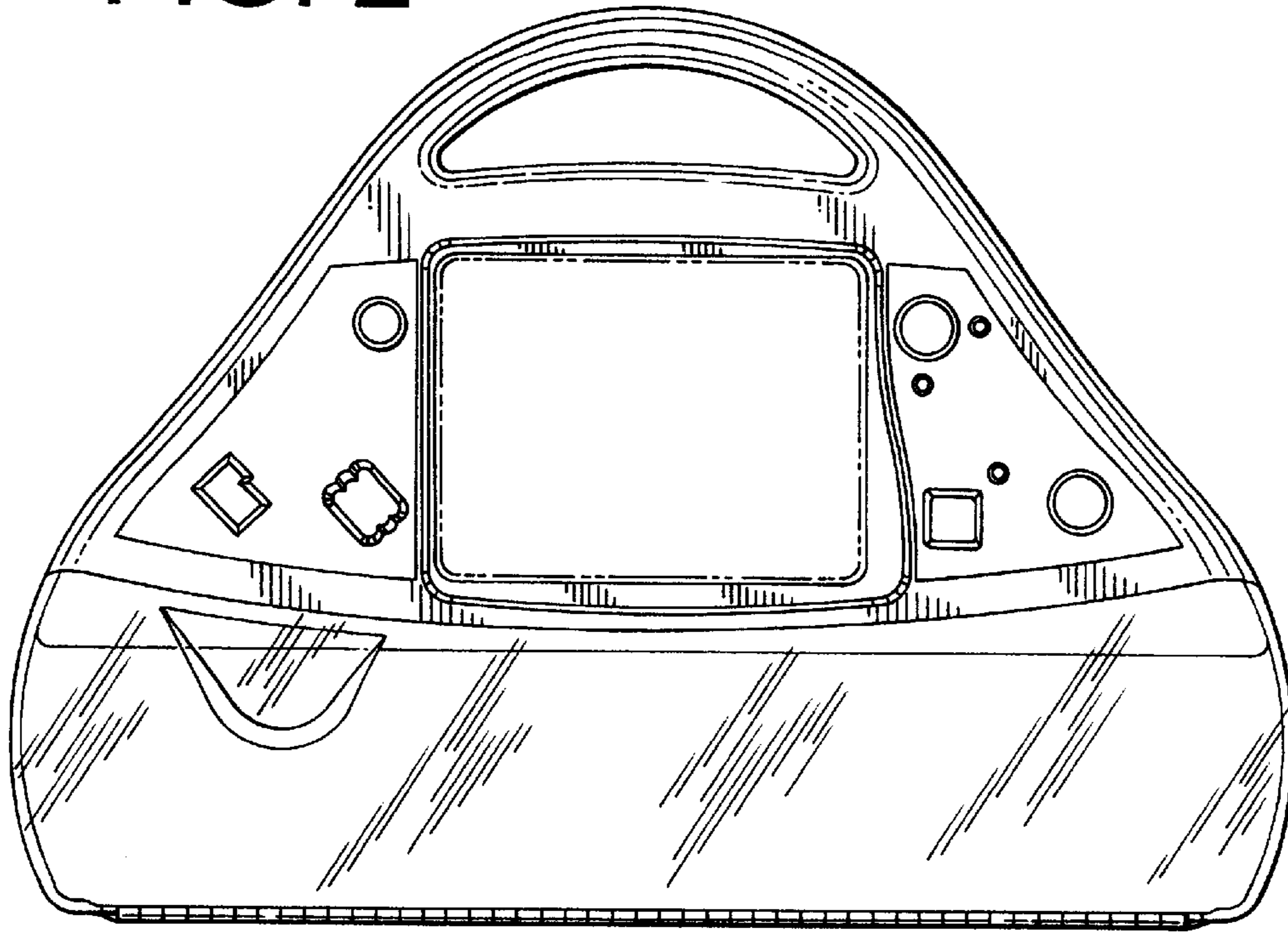

FIG. 3

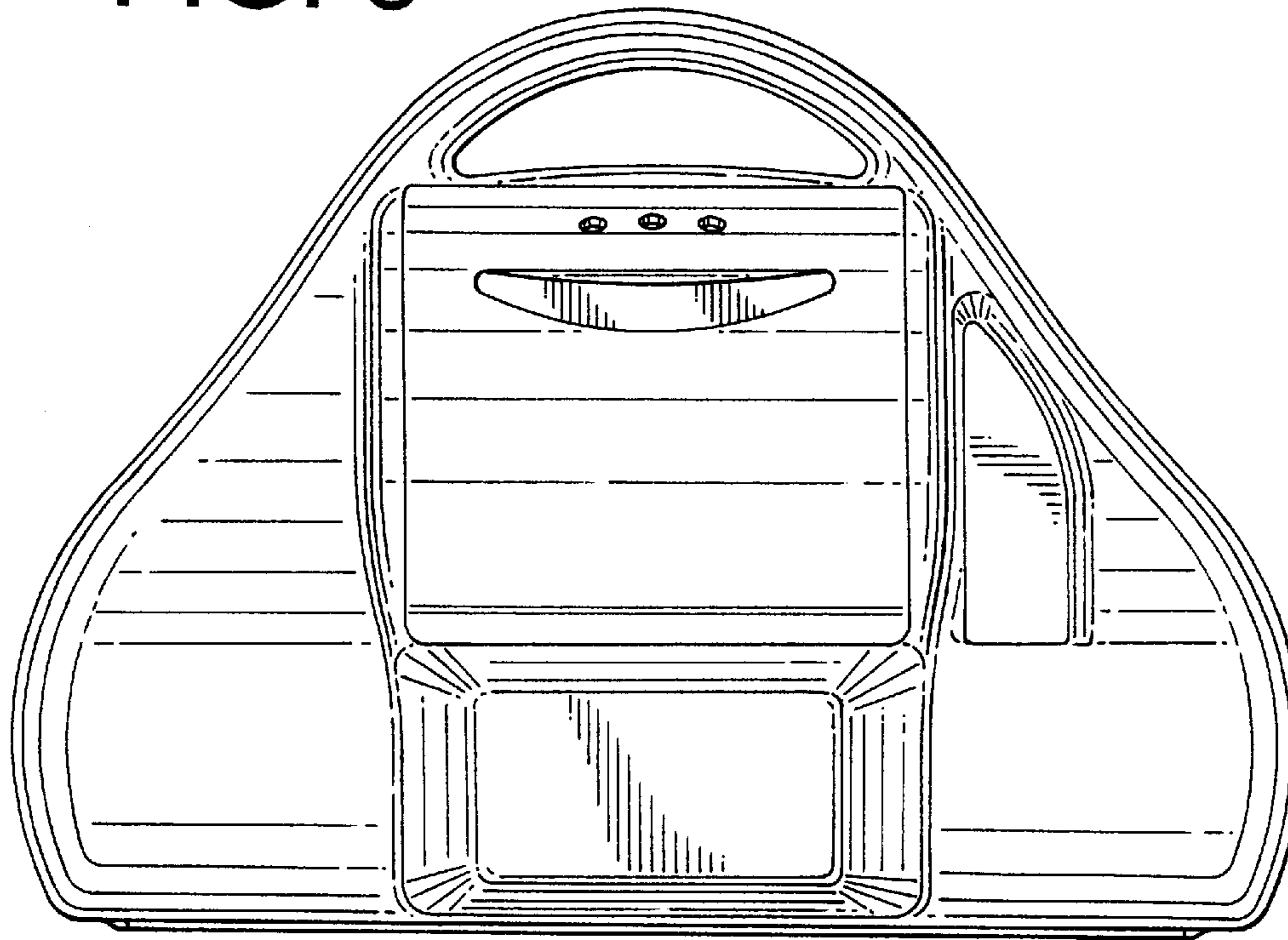

FIG. 4

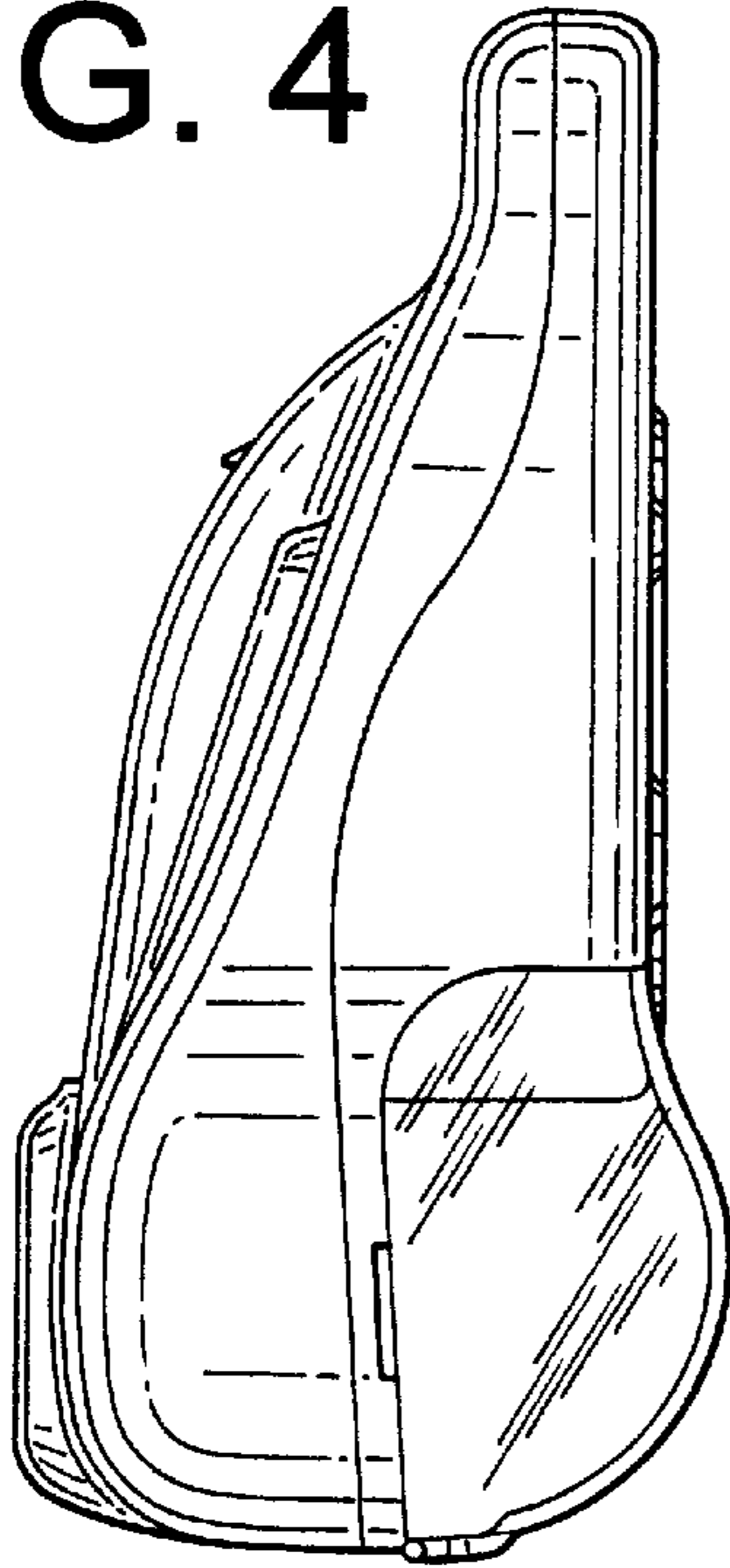

FIG. 5

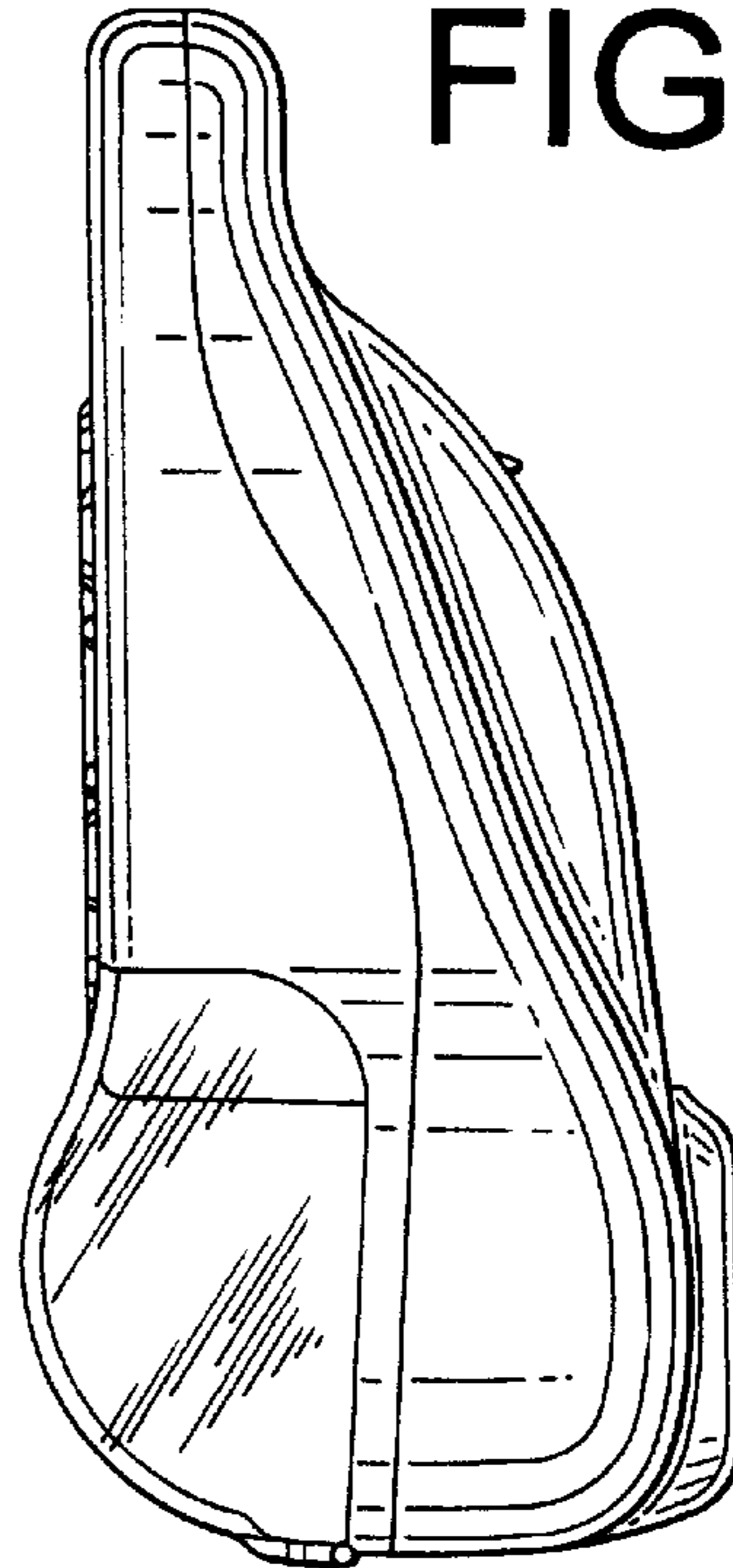

FIG. 6

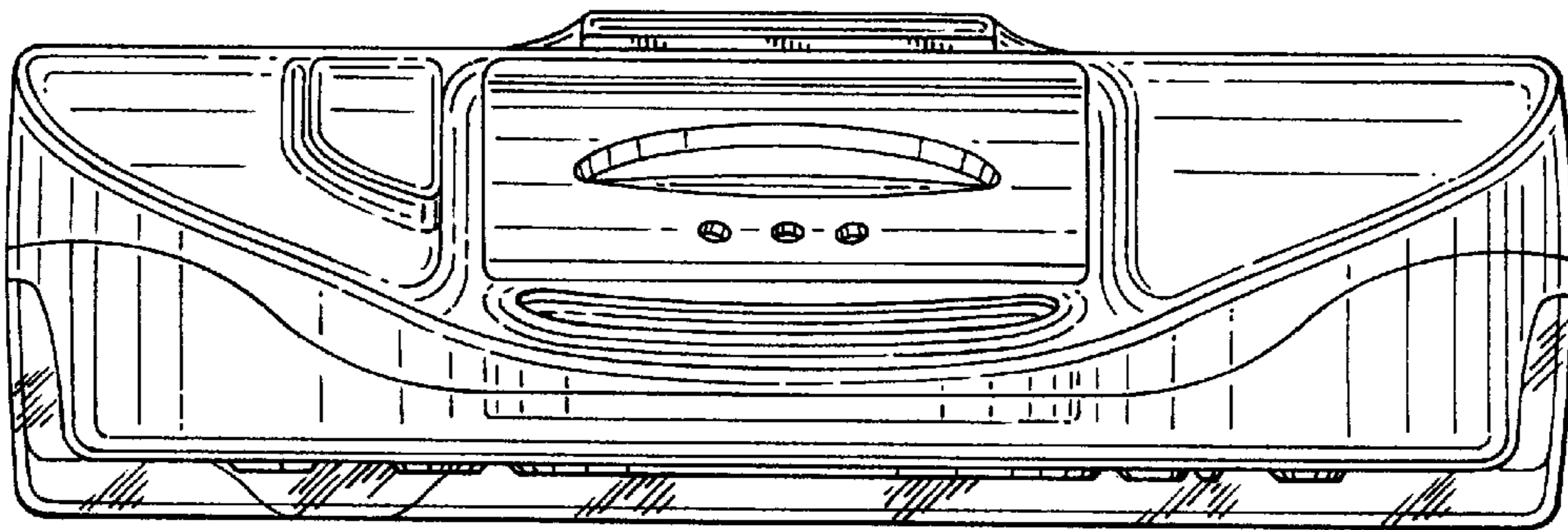

FIG. 7

