



US00D475332S

(12) **United States Design Patent**  
**Chiang**

(10) **Patent No.:** **US D475,332 S**

(45) **Date of Patent:** **\*\* Jun. 3, 2003**

(54) **ENGINE HOOD FOR AUTOMOBILES**

(75) **Inventor:** **Tommy Chiang, Taipei (TW)**

(73) **Assignee:** **Grand HC Auto Tooling Corp., Taipei (TW)**

(\*\*) **Term:** **14 Years**

(21) **Appl. No.:** **29/167,022**

(22) **Filed:** **Sep. 9, 2002**

(51) **LOC (7) Cl. .... 12-16**

(52) **U.S. Cl. .... D12/173**

(58) **Field of Search ..... D12/173, 90-92, D12/86; 180/69.21, 69.2, 69.22, 69.25**

(56) **References Cited**

**U.S. PATENT DOCUMENTS**

D403,272 S \* 12/1998 Cadotte et al. .... D12/173

D463,335 S \* 9/2002 Hoyle, Jr. .... D12/173

\* cited by examiner

*Primary Examiner*—Melody N. Brown

(74) *Attorney, Agent, or Firm*—Leong C. Lei

(57) **CLAIM**

The ornamental design for an engine hood for automobiles, as shown and described.

**DESCRIPTION**

FIG. 1 is perspective view of an engine hood for automobiles showing my new design;

FIG. 2 is a front side elevation view thereof;

FIG. 3 is a rear side elevation view thereof;

FIG. 4 is a left side elevation view thereof;

FIG. 5 is a right side elevation view thereof;

FIG. 6 is a top plan view thereof; and,

FIG. 7 is a bottom plan view thereof.

**1 Claim, 5 Drawing Sheets**

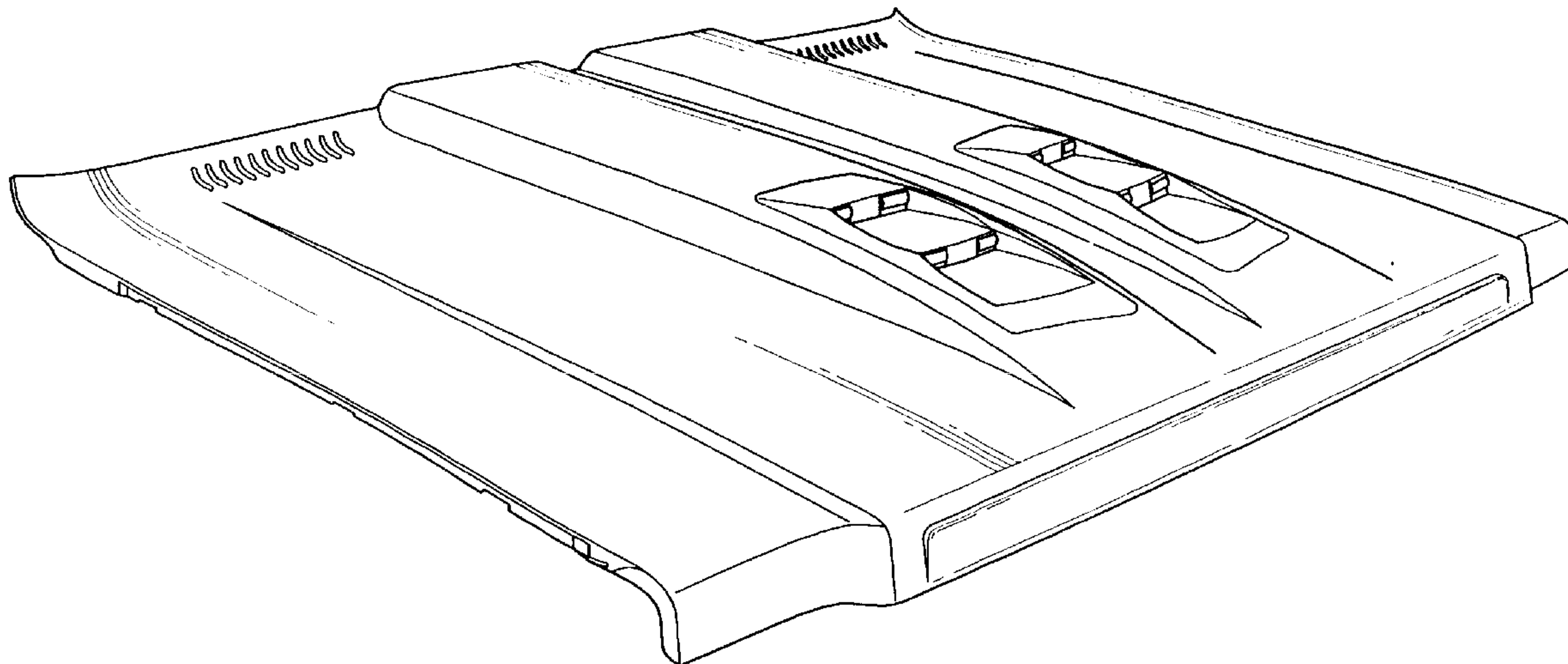

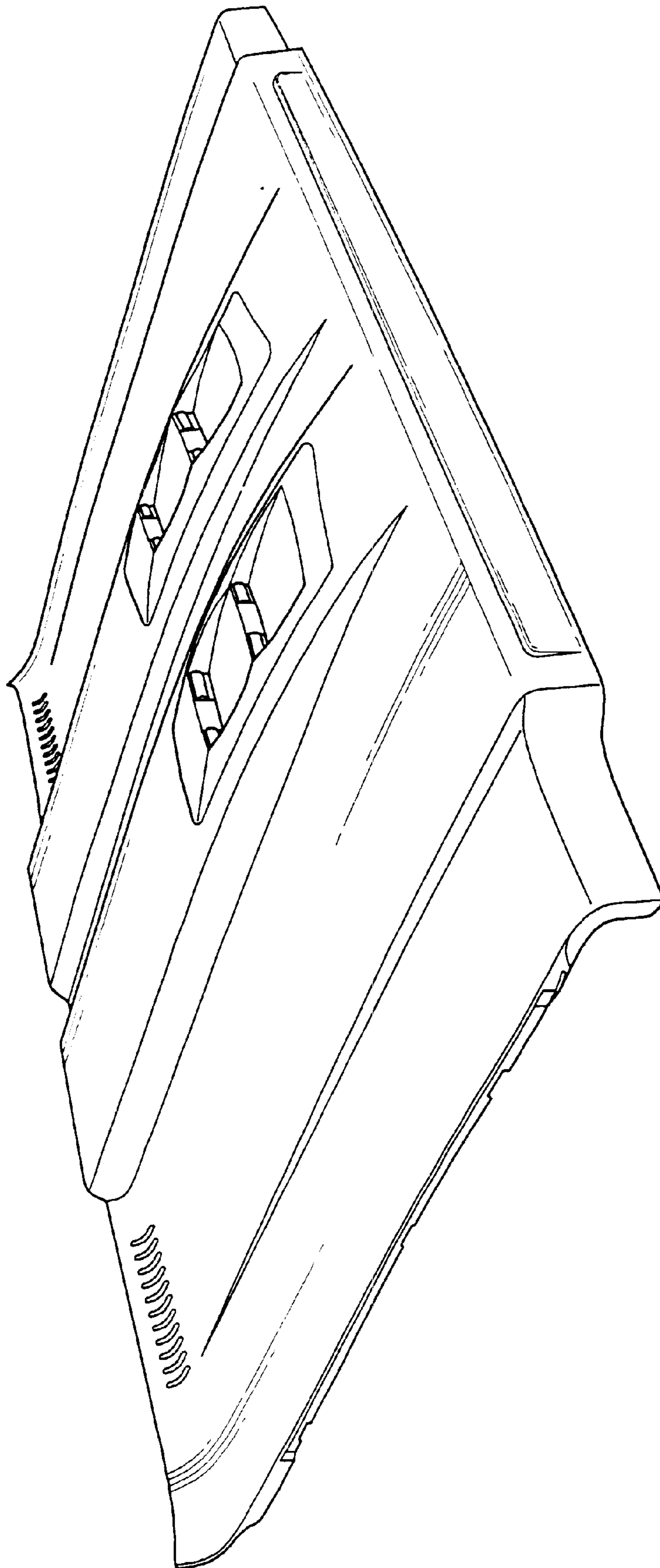

FIG. 1

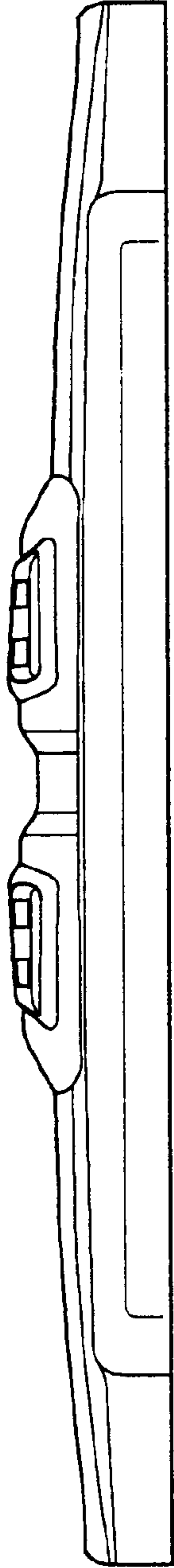

FIG. 2

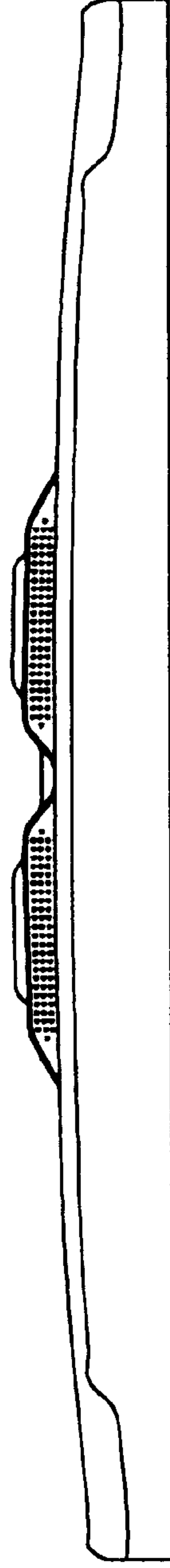

FIG. 3



FIG. 4

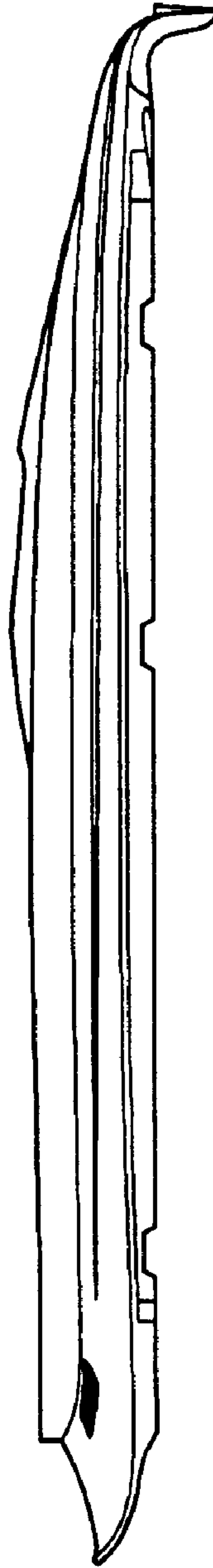

FIG. 5

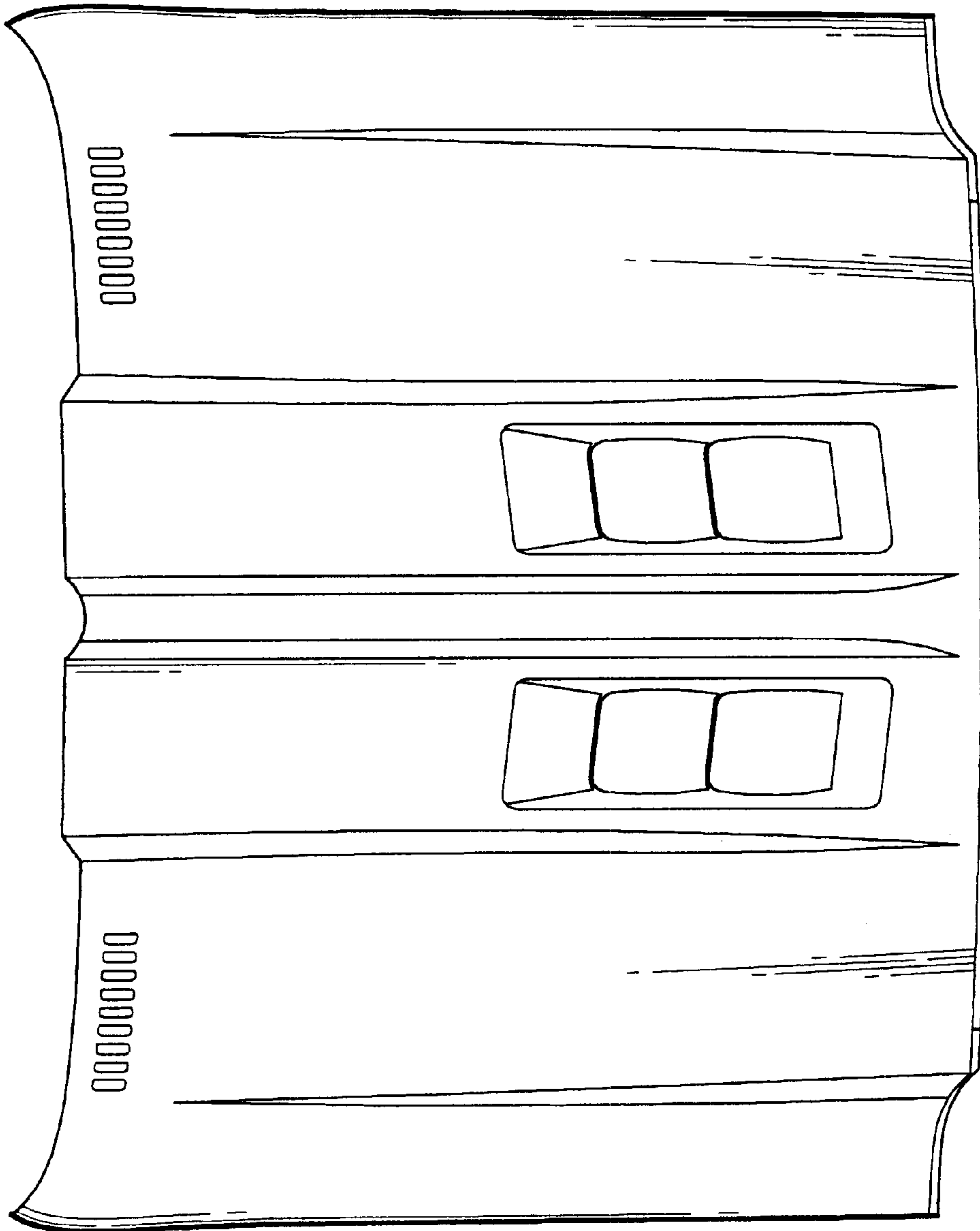

FIG. 6

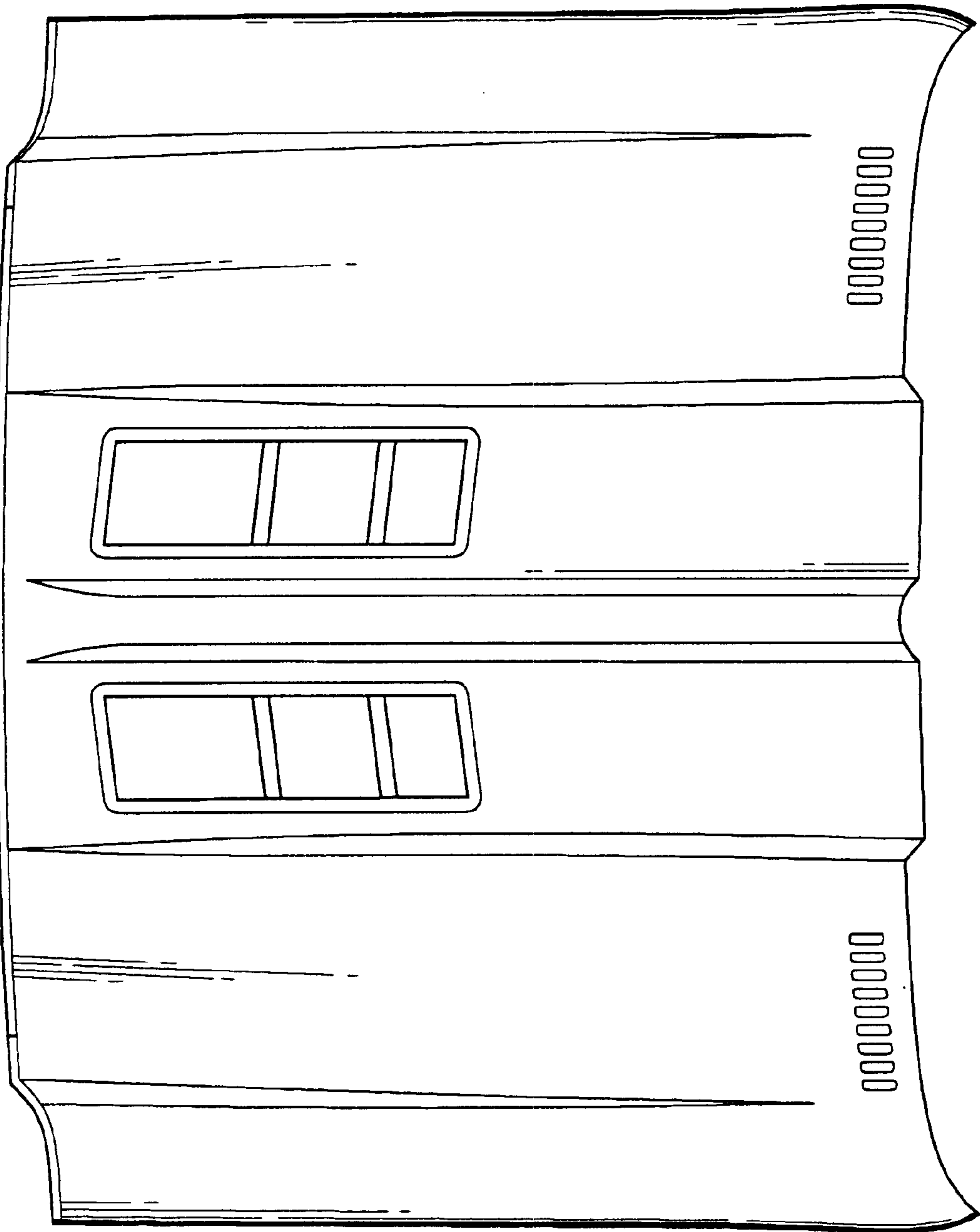

FIG. 7