



US00D475329S

(12) **United States Design Patent**
Okumoto et al.

(10) **Patent No.:** **US D475,329 S**

(45) **Date of Patent:** **** Jun. 3, 2003**

(54) **FRONT GRILL OF AN AUTOMOBILE**

D452,837 S * 1/2002 Kitamura D12/163
D463,334 S * 9/2002 Koman D12/169
D464,296 S * 10/2002 Nemoto D12/163

(75) Inventors: **Toshiyuki Okumoto**, Wako (JP);
Keisuke Morioka, Wako (JP); **Joji Arisada**, Wako (JP); **Norihito Haguchi**, Wako (JP)

* cited by examiner

(73) Assignee: **Honda Giken Kogyo Kabushiki Kaisha**, Tokyo (JP)

Primary Examiner—Melody N. Brown
(74) *Attorney, Agent, or Firm*—Arent Fox Kintner Plotkin & Kahn, PLLC

(**) Term: **14 Years**

(57) **CLAIM**

(21) Appl. No.: **29/162,946**

The ornamental design for a front grill of an automobile, as shown and described.

(22) Filed: **Jun. 26, 2002**

DESCRIPTION

(30) **Foreign Application Priority Data**

Dec. 27, 2001 (JP) 2001-038578

FIG. 1 is a front view of a front grill of an automobile showing our new design.

(51) **LOC (7) Cl.** **12-16**

FIG. 2 is a rear view thereof.

(52) **U.S. Cl.** **D12/163**

FIG. 3 is a plan view thereof.

(58) **Field of Search** D12/163, 90-92;
180/86.1, 86.6; 296/194

FIG. 4 is a bottom view thereof.

FIG. 5 is a right side view thereof.

FIG. 6 is a left side view thereof; and,

FIG. 7 is a perspective view thereof.

(56) **References Cited**

U.S. PATENT DOCUMENTS

D447,726 S * 9/2001 Okano D12/169

1 Claim, 3 Drawing Sheets

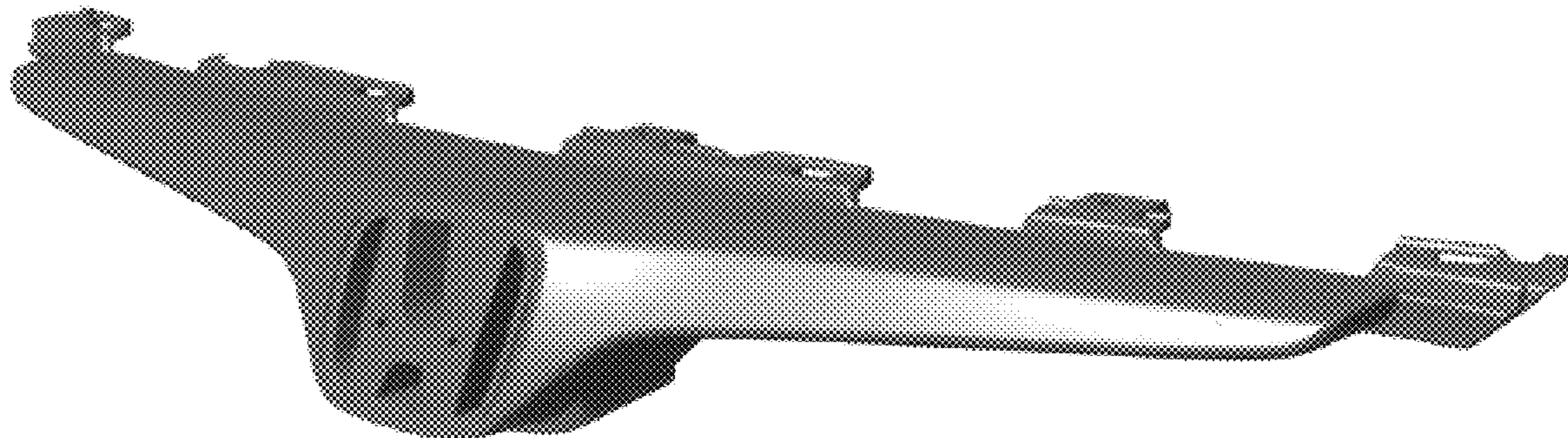

FIG.1

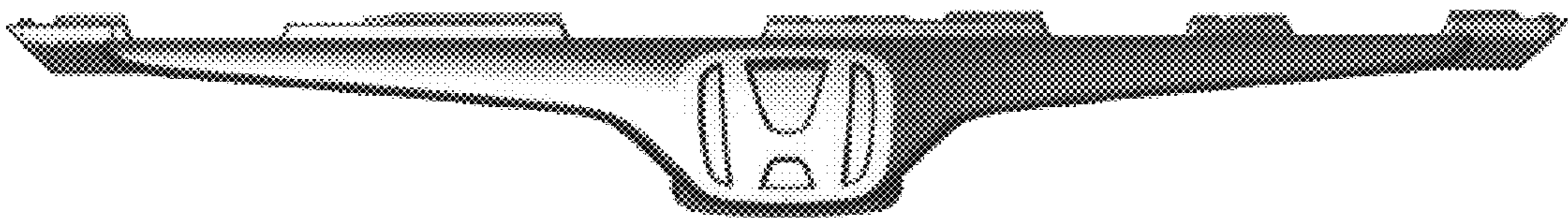

FIG.2

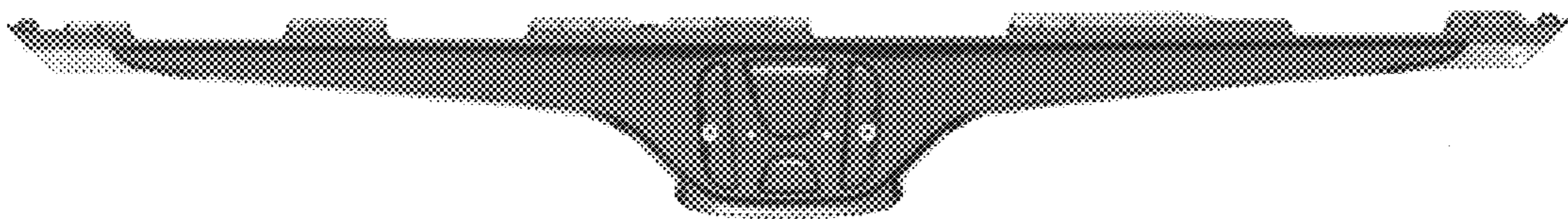

FIG.3

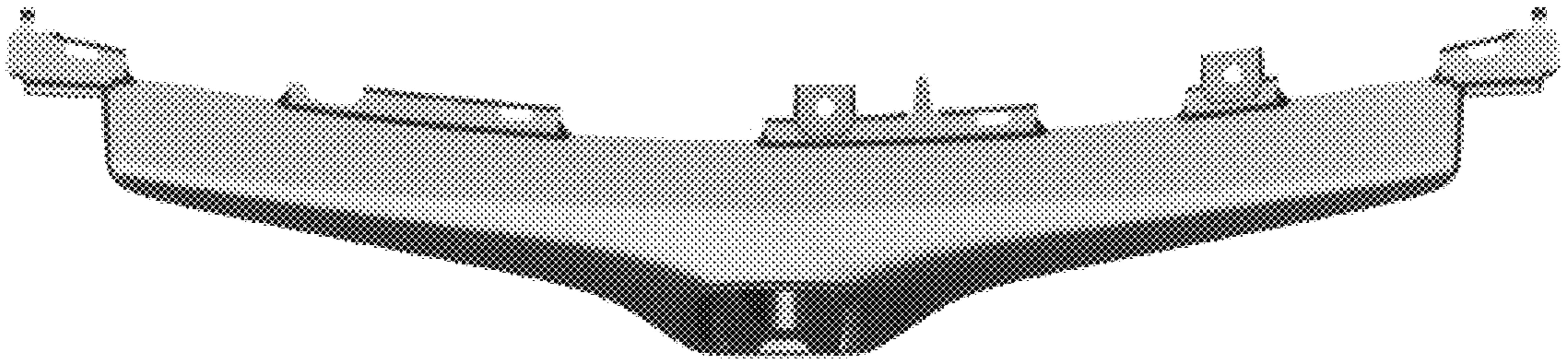

FIG.4

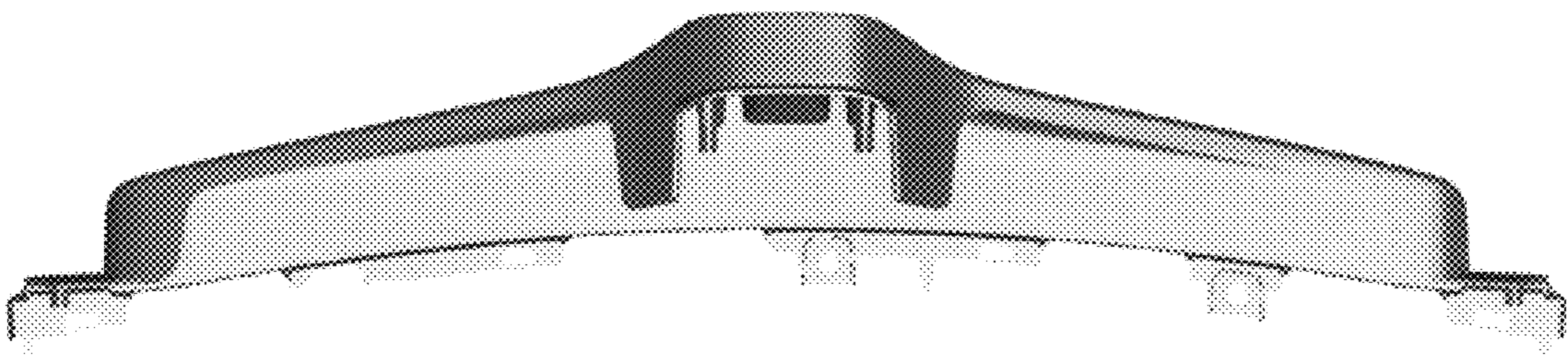

FIG.5

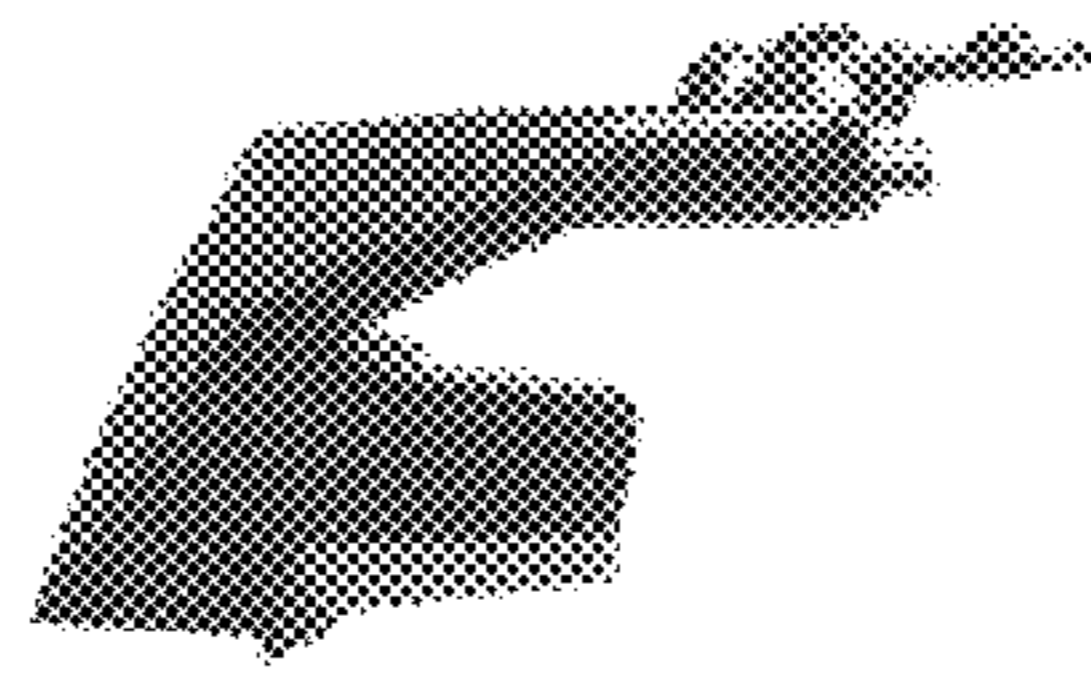

FIG.6

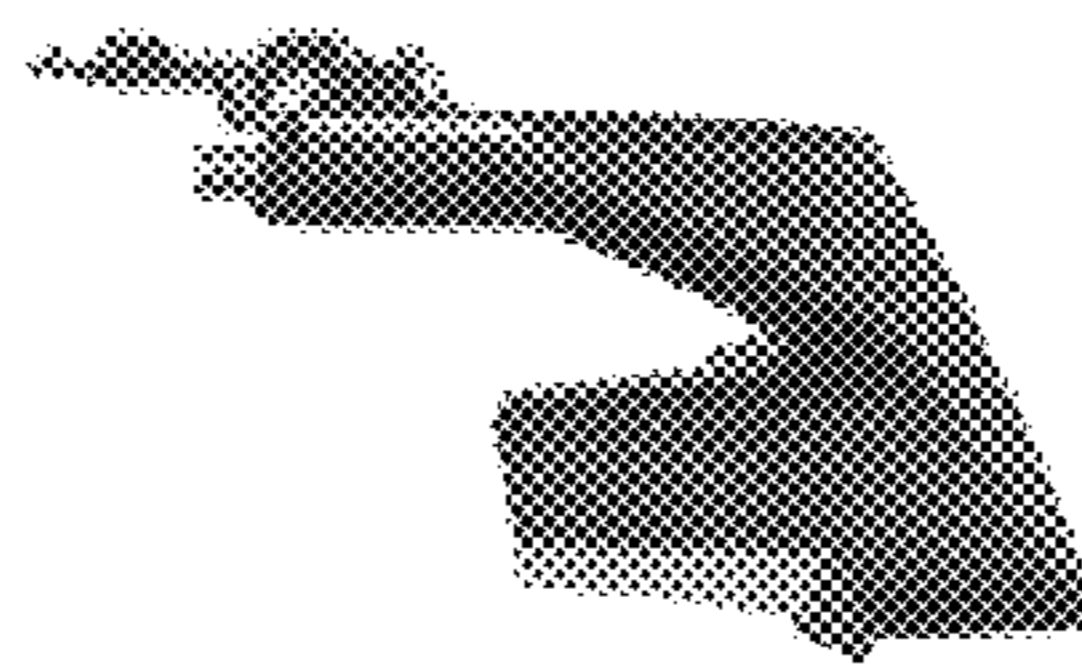

FIG.7

