



US00D475241S

(12) **United States Design Patent**
Mattiuzzo

(10) **Patent No.:** **US D475,241 S**

(45) **Date of Patent:** **** Jun. 3, 2003**

(54) **TAP FOR DRINKS**

(75) Inventor: **Giulio Mattiuzzo**, Vigevano (IT)

(73) Assignee: **CELLI S.p.A.**, Coriano (IT)

(**) Term: **14 Years**

(21) Appl. No.: **29/149,993**

(22) Filed: **Oct. 29, 2001**

(30) **Foreign Application Priority Data**

Apr. 27, 2001 (IT) RN2001O000006

(51) **LOC (7) Cl.** **07-99**

(52) **U.S. Cl.** **D7/398; D7/397**

(58) **Field of Search** D7/398, 397, 387,
D7/313, 392, 307, 306, 308; 222/400.7,
518, 402.1, 25, 566, 544, 83, 81, 516, 183;
D23/238, 255, 233; 62/389; 99/300; 141/98

(56) **References Cited**

U.S. PATENT DOCUMENTS

- 4,252,160 A * 2/1981 Numbers 141/98
- D273,453 S * 4/1984 Knopf D7/398
- 4,505,191 A * 3/1985 Longo 99/300
- D280,880 S * 10/1985 Schweres D7/398
- 4,674,296 A * 6/1987 Renaud 62/389

- D304,665 S * 11/1989 Start D7/313
- 5,232,129 A * 8/1993 Guerra 222/183
- D339,717 S * 9/1993 Guerra D7/392
- D352,637 S * 11/1994 Ugolini D7/398
- D412,262 S * 7/1999 Roundtree D7/307
- 6,158,626 A * 12/2000 Guerra et al. 222/183
- D440,631 S * 4/2001 Shipway D23/233

* cited by examiner

Primary Examiner—M. N. Pandozzi

(74) *Attorney, Agent, or Firm*—Browdy and Neimark, P.L.L.C.

(57) **CLAIM**

The ornamental design for a tap for drinks, as shown and described.

DESCRIPTION

FIG. 1 is an oblique elevational view of a tap for drinks showing my new design;
 FIG. 2 is a left side elevational view thereof;
 FIG. 3 is a front elevation view thereof;
 FIG. 4 is a top plan view thereof;
 FIG. 5 is a rear elevational view thereof,
 FIG. 6 is a right side elevational view thereof; and,
 FIG. 7 is a bottom plan view thereof.

1 Claim, 2 Drawing Sheets

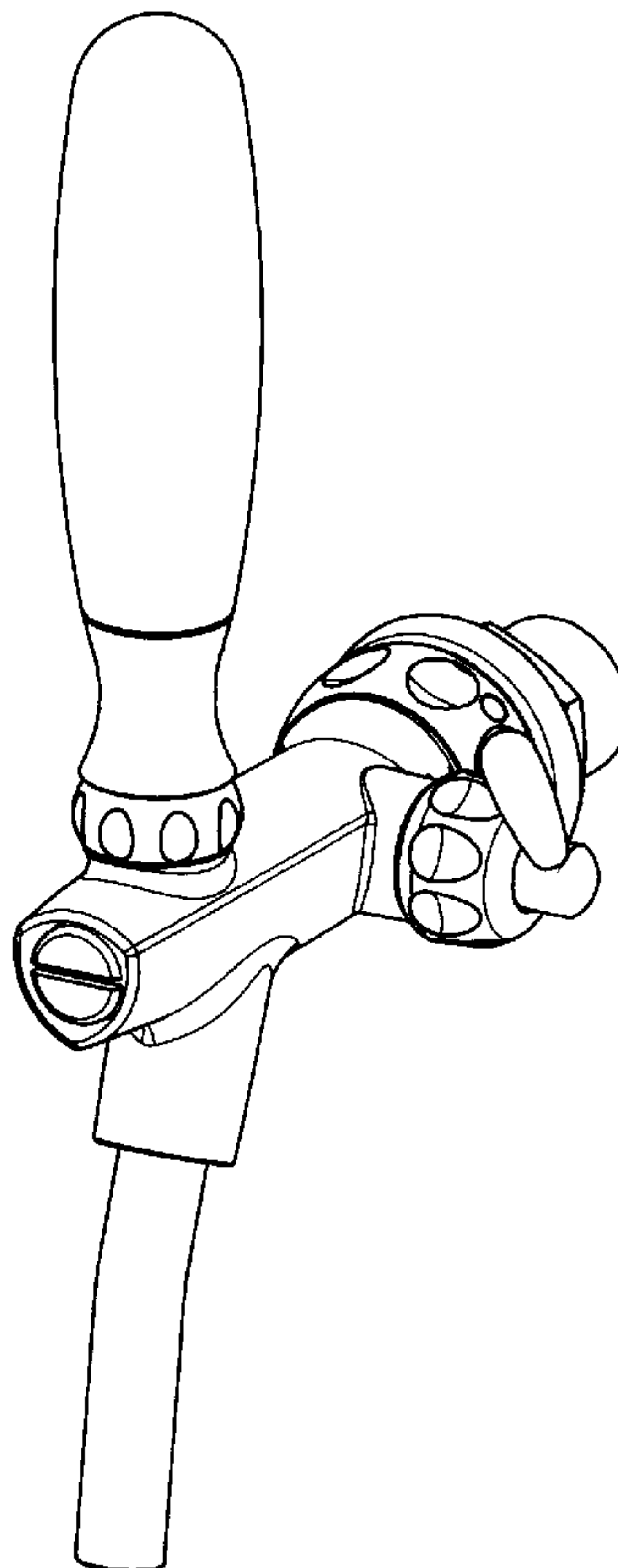

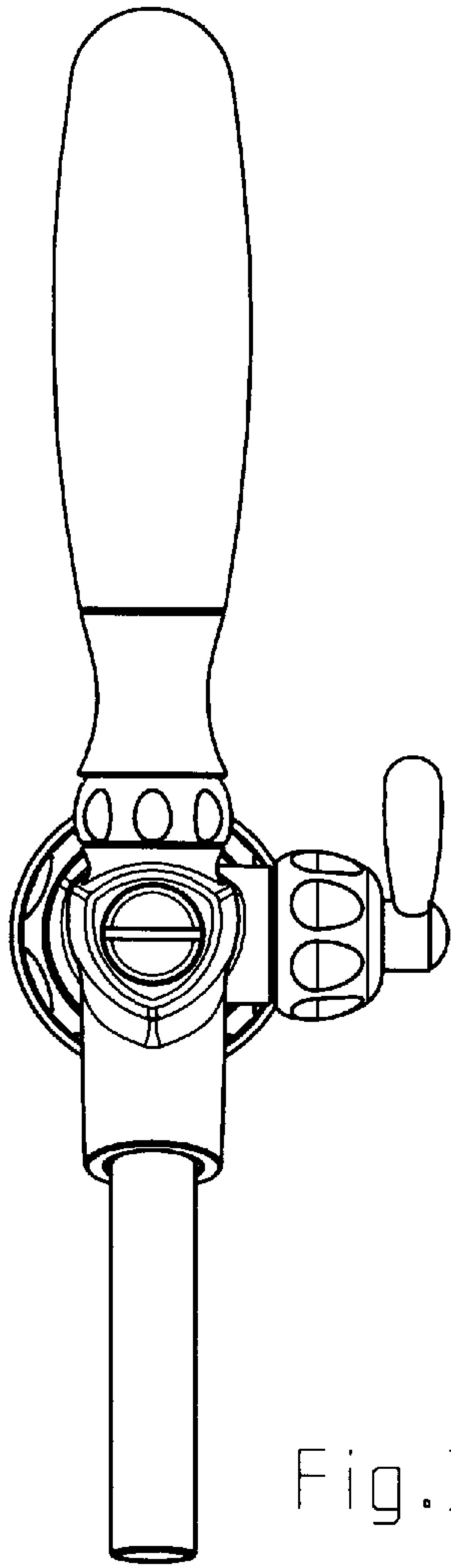

Fig.3

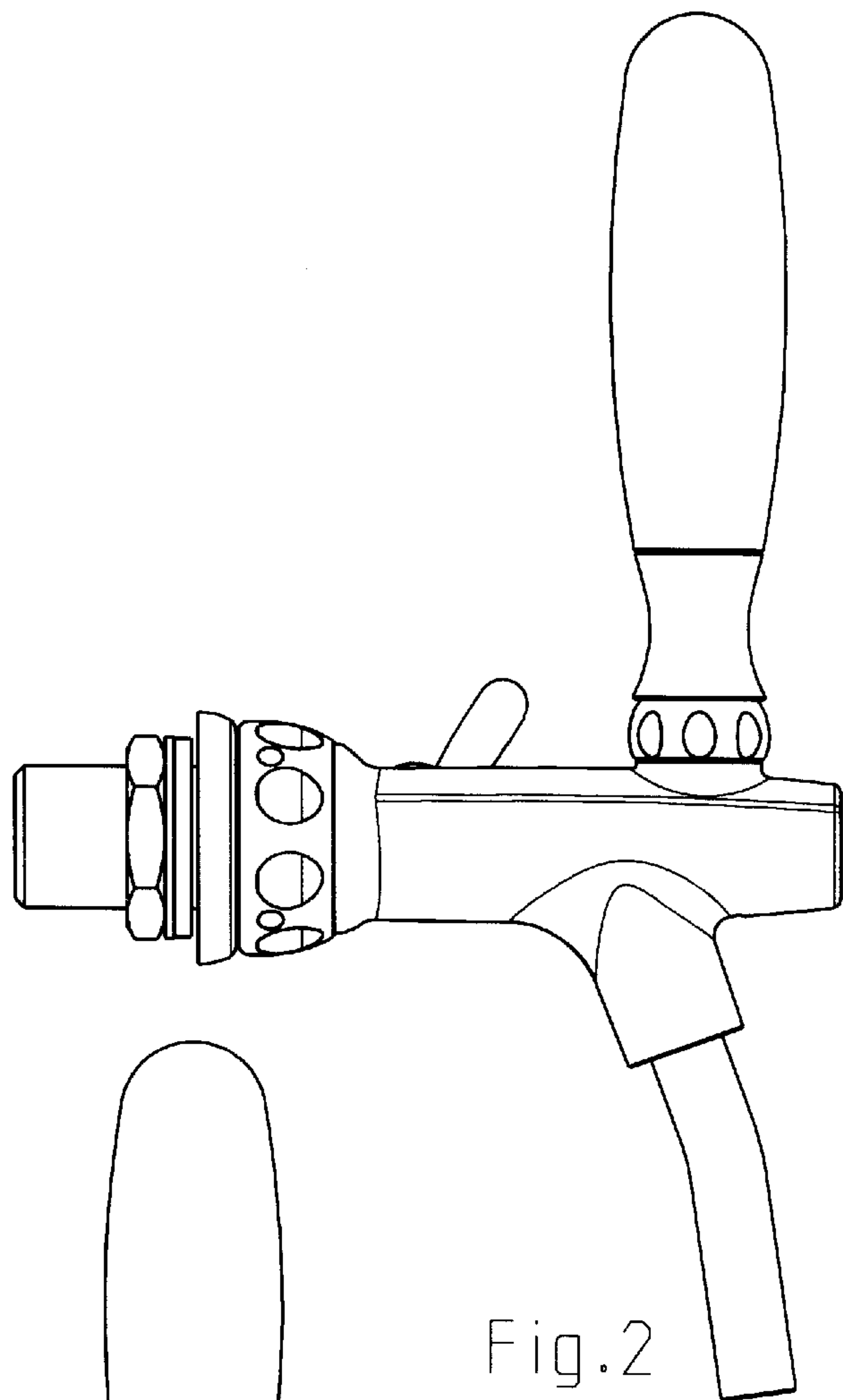

Fig.2

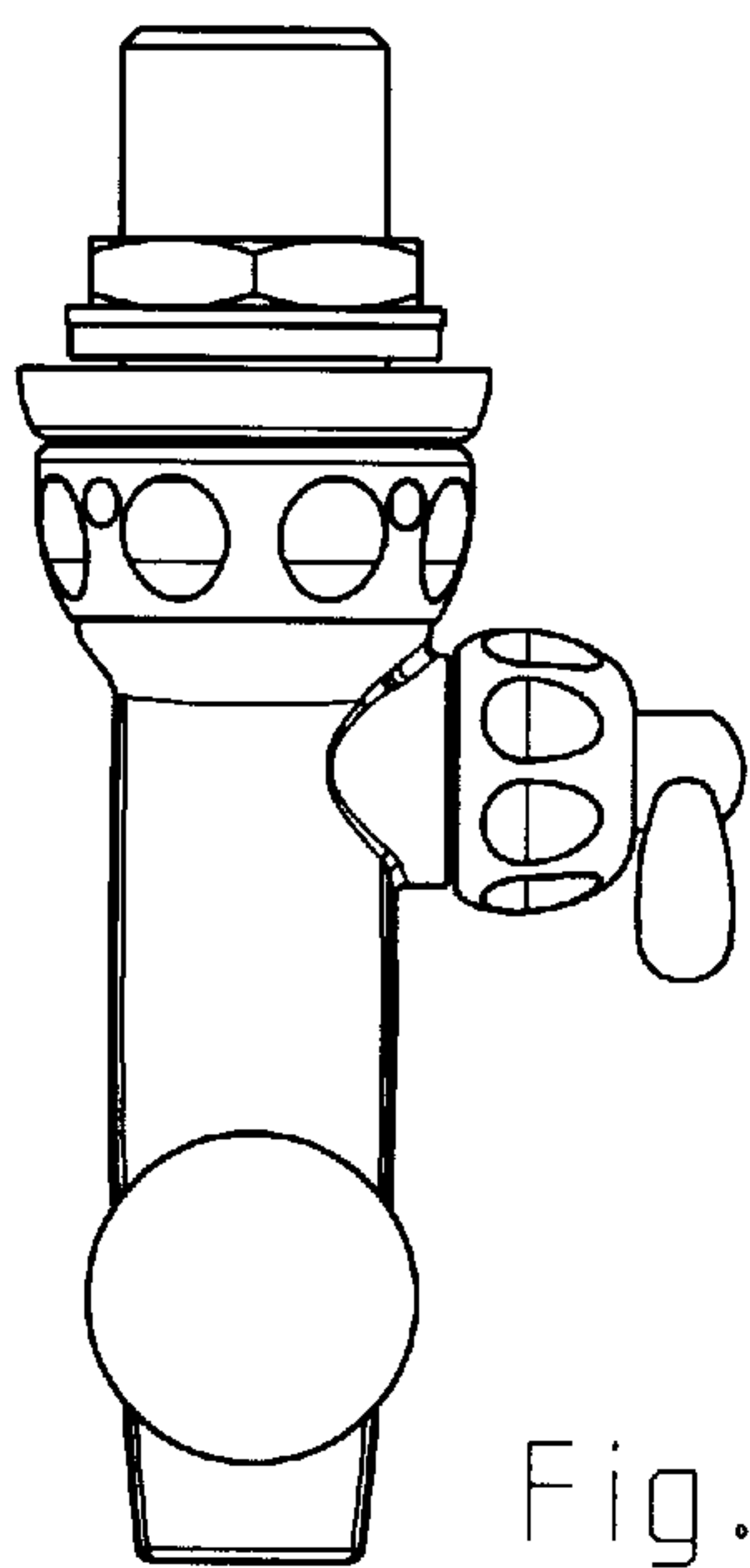

Fig.4

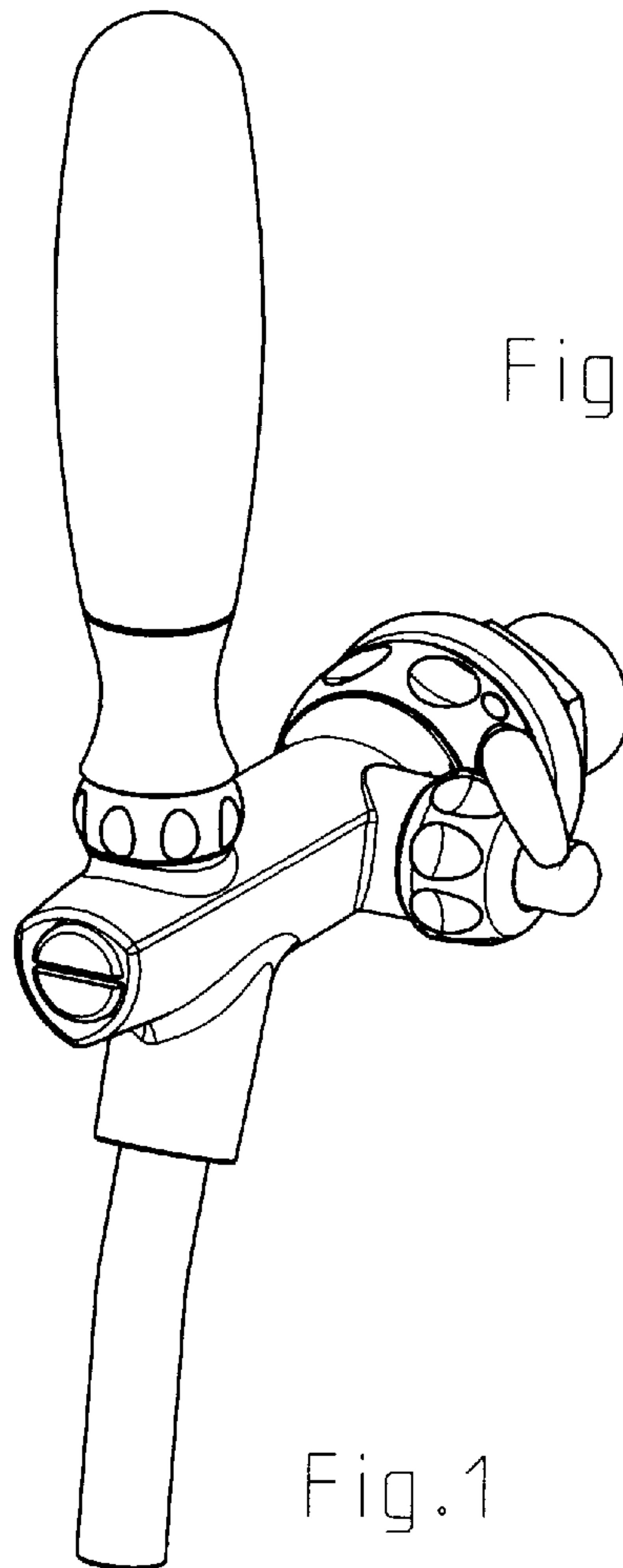

Fig.1

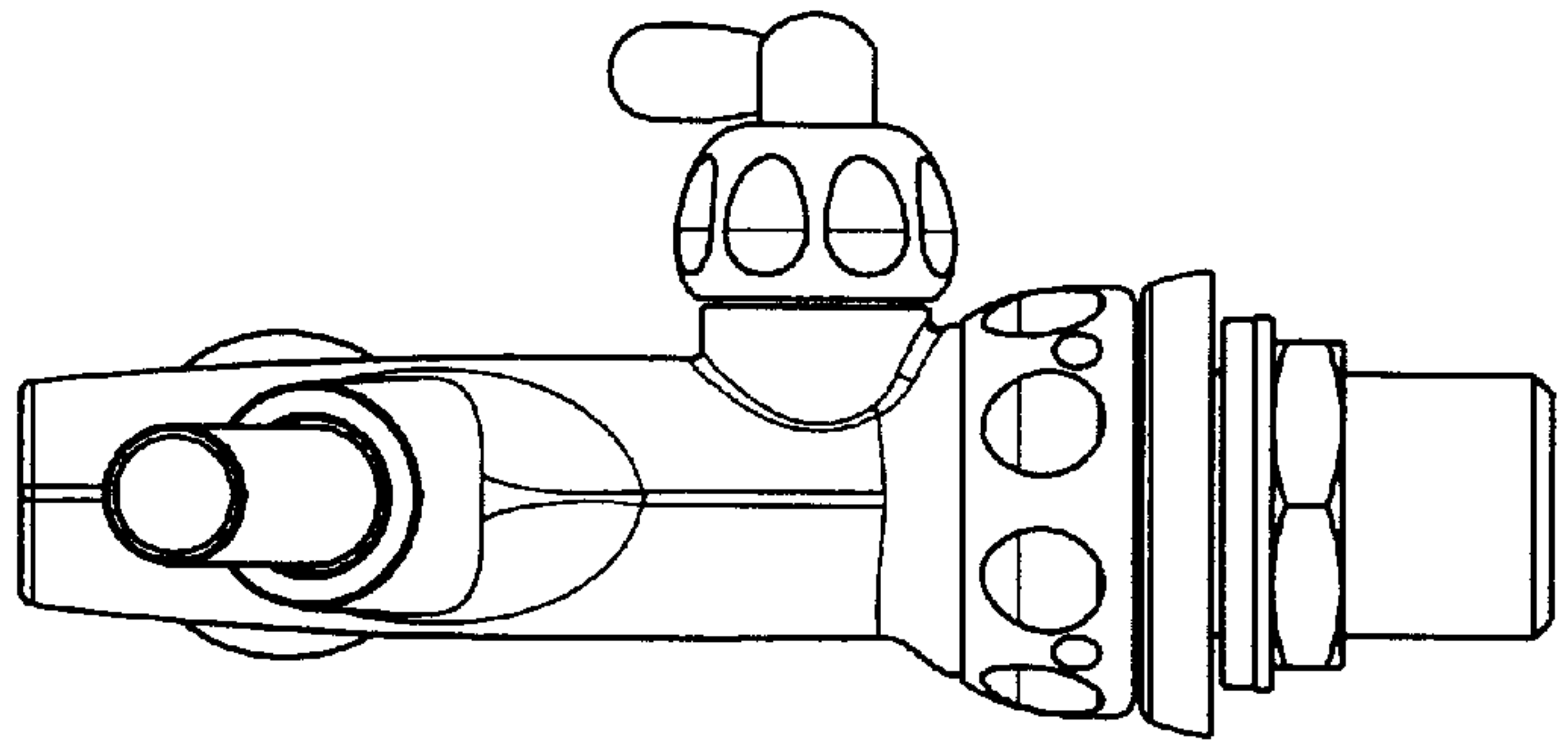

Fig. 7

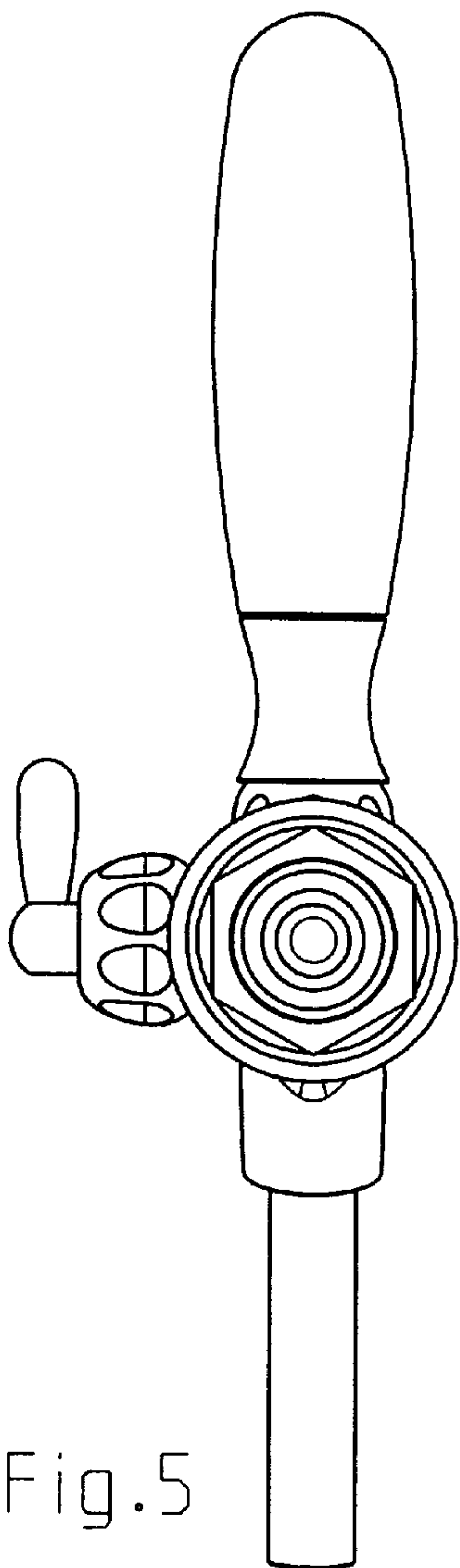

Fig. 5

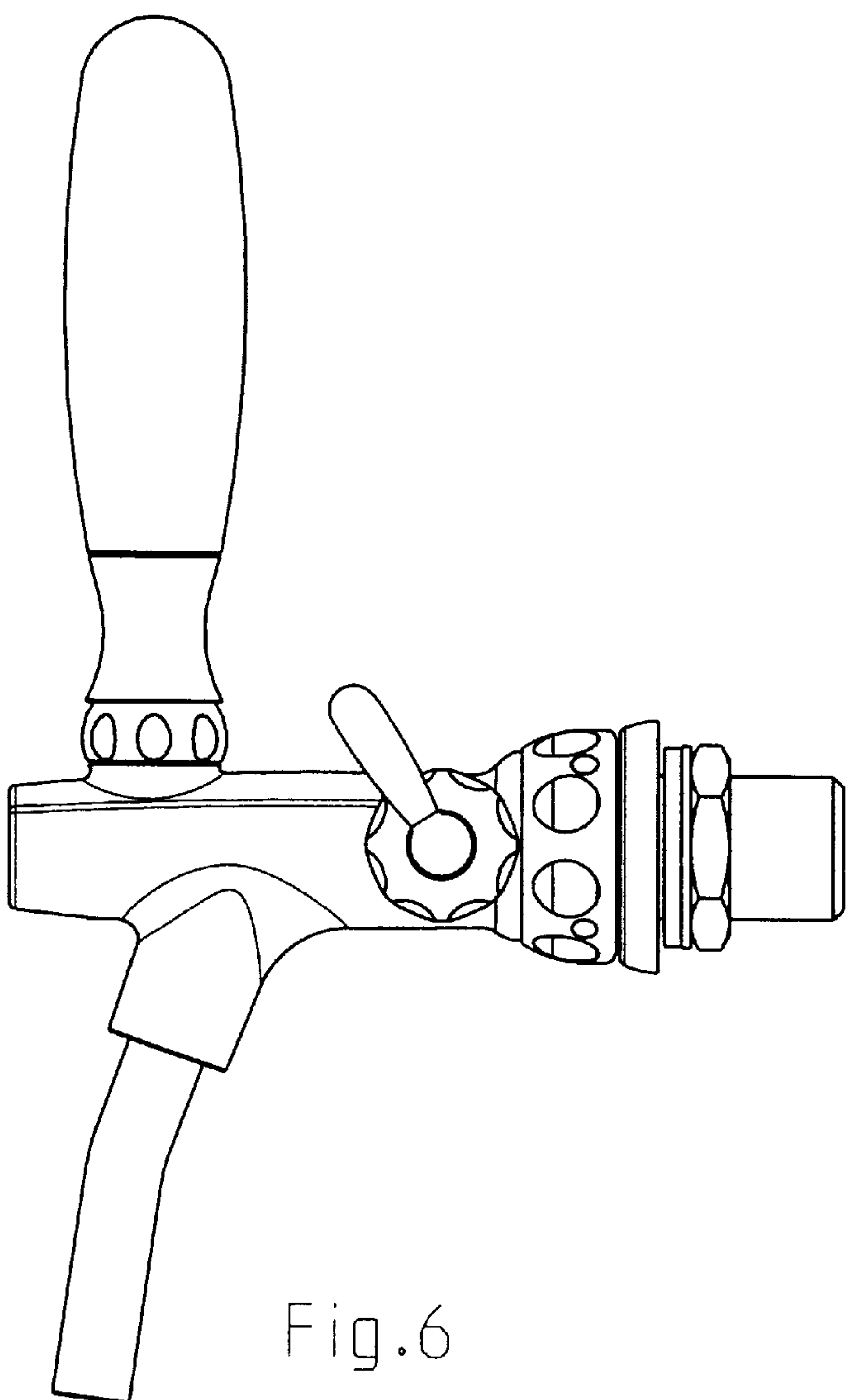

Fig. 6