



US00D475203S

(12) **United States Design Patent**
Vaes

(10) **Patent No.:** **US D475,203 S**

(45) **Date of Patent:** **** Jun. 3, 2003**

(54) **PAINT BRUSH HANDLE**

(76) **Inventor:** **Ed Vaes**, 223 Avondale Street,
Hamilton, Ontario (CA), L8L 7C4

(**) **Term:** **14 Years**

(21) **Appl. No.:** **29/150,748**

(22) **Filed:** **Nov. 30, 2001**

(51) **LOC (7) Cl.** **04-04**

(52) **U.S. Cl.** **D4/138**

(58) **Field of Search** D4/132, 135, 138;
15/143.1, 159.1, 160, 168, 171, 175, 176.1,
191.1, 192-196, 202; 16/110.1, 430

(56) **References Cited**

U.S. PATENT DOCUMENTS

1,826,165	A	*	10/1931	Cartwright	15/143.1
2,490,159	A	*	12/1949	Ricchiuti	15/202
2,589,779	A	*	3/1952	Cortes	15/202
2,629,125	A	*	2/1953	Ferguson	15/202
4,494,268	A	*	1/1985	Chu	15/176.1
4,598,437	A	*	7/1986	Ernest et al.	15/176.1
D412,618	S	*	8/1999	Parker et al.	D4/132
D453,628	S	*	2/2002	Tapley et al.	D4/138
D454,432	S	*	3/2002	Ancona et al.	D4/138
6,408,474	B1	*	6/2002	Husted et al.	15/143.1

OTHER PUBLICATIONS

The Painter's Advantage, Ltd., © 1986, Chip Brushes,
bottom, right of p. 5.*

* cited by examiner

Primary Examiner—Alan P. Douglas
Assistant Examiner—Lavone D. Tabor

(57) **CLAIM**

The ornamental design for a paint brush handle, as shown.

DESCRIPTION

FIG. 1 is a top plan view of a paint brush handle showing my new design;

FIG. 2 is a side elevational view of FIG. 1;

FIG. 3 is a reduced top, front perspective view of FIG. 1;

FIG. 4 is a reduced bottom, rear perspective view of FIG. 1;

FIG. 5 is a top plan view of a second embodiment of the paint brush handle;

FIG. 6 is a side elevational view of FIG. 5;

FIG. 7 is a top, front perspective view of FIG. 5;

FIG. 8 is a bottom, rear perspective view of FIG. 5;

FIG. 9 is a top plan view of a third embodiment of the paint brush handle;

FIG. 10 is a side elevational view of FIG. 9;

FIG. 11 is a top, front perspective view of FIG. 9;

FIG. 12 is a bottom, rear perspective view of FIG. 9;

FIG. 13 is a top plan view of a fourth embodiment of the paint brush handle;

FIG. 14 is a side elevational view of FIG. 13;

FIG. 15 is a top, front perspective view of FIG. 13;

FIG. 16 is a bottom, rear perspective view of FIG. 13;

FIG. 17 is a top plan view of a fifth embodiment of the paint brush handle;

FIG. 18 is a side elevational view of FIG. 17;

FIG. 19 is a top, front perspective view of FIG. 17; and,

FIG. 20 is a bottom, rear perspective view of FIG. 17.

1 Claim, 10 Drawing Sheets

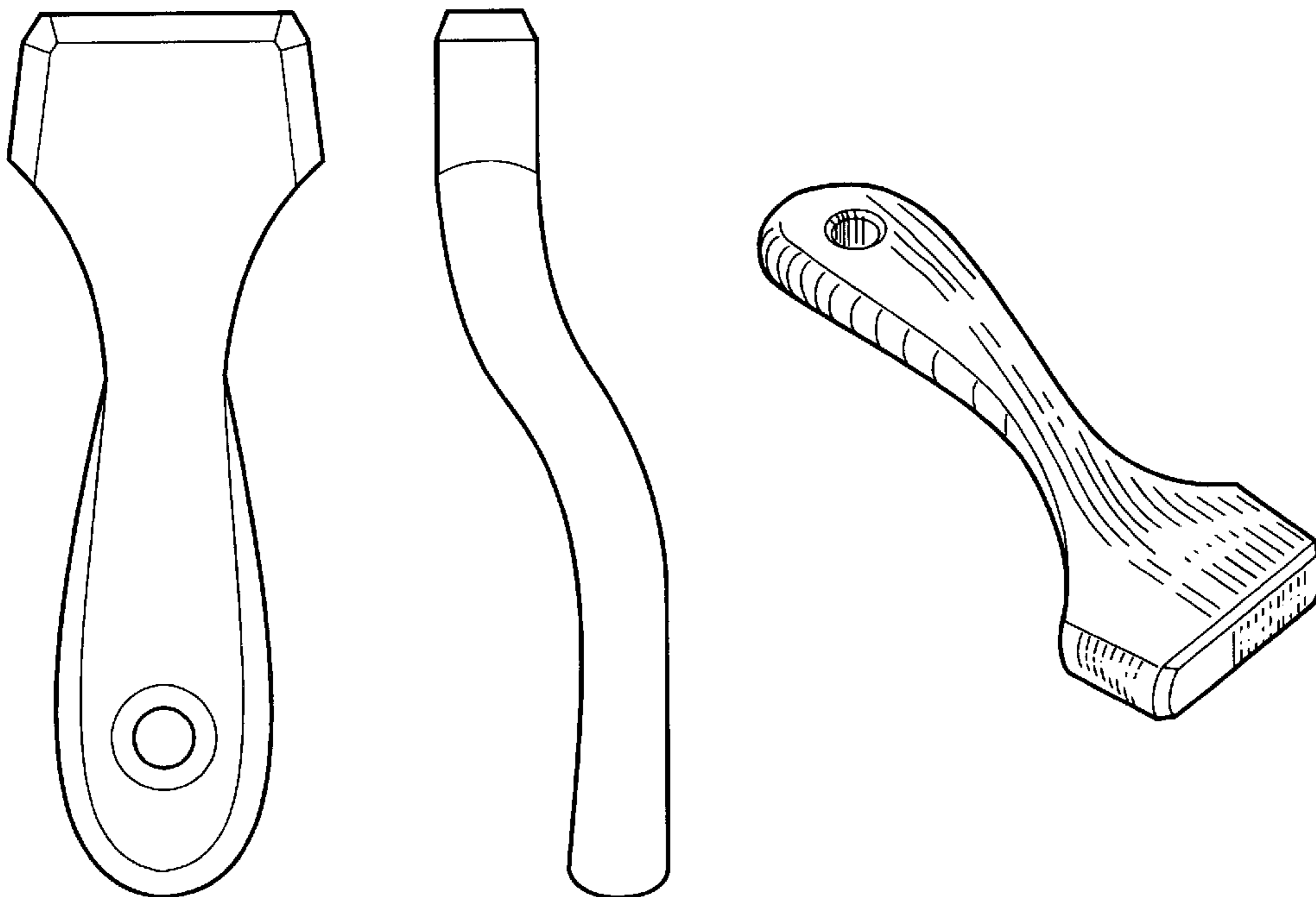

FIG. 1

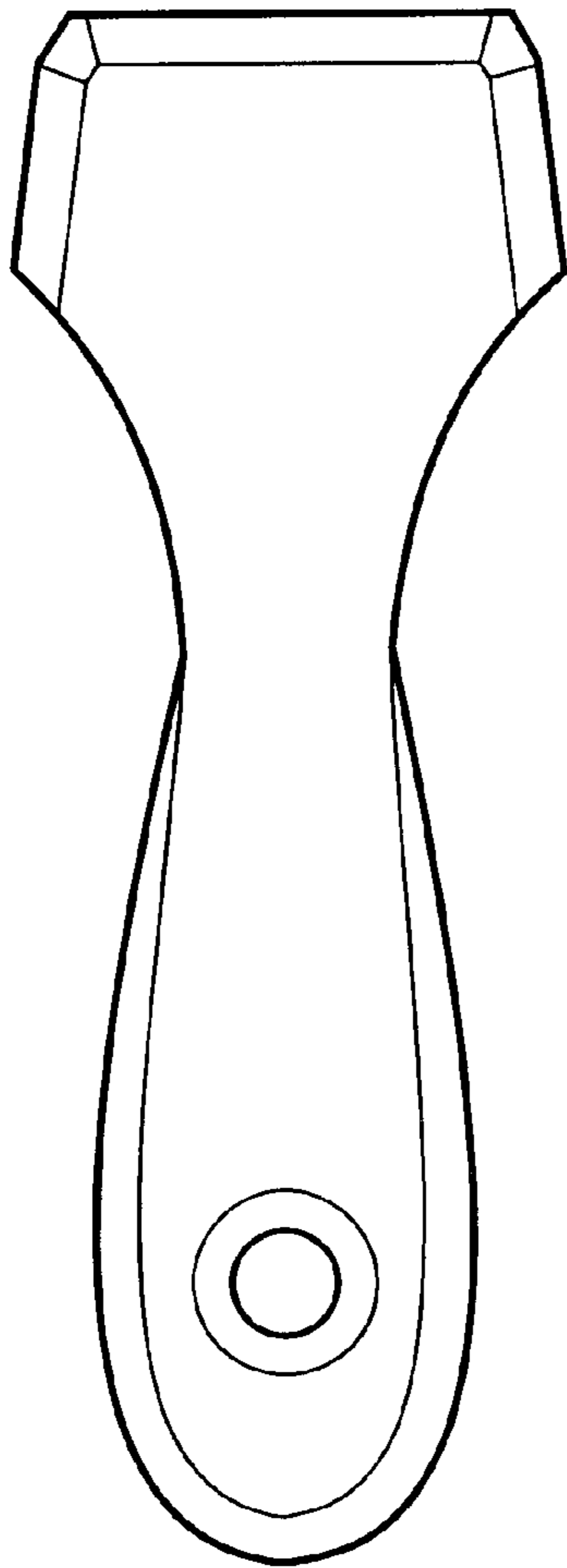

FIG. 2

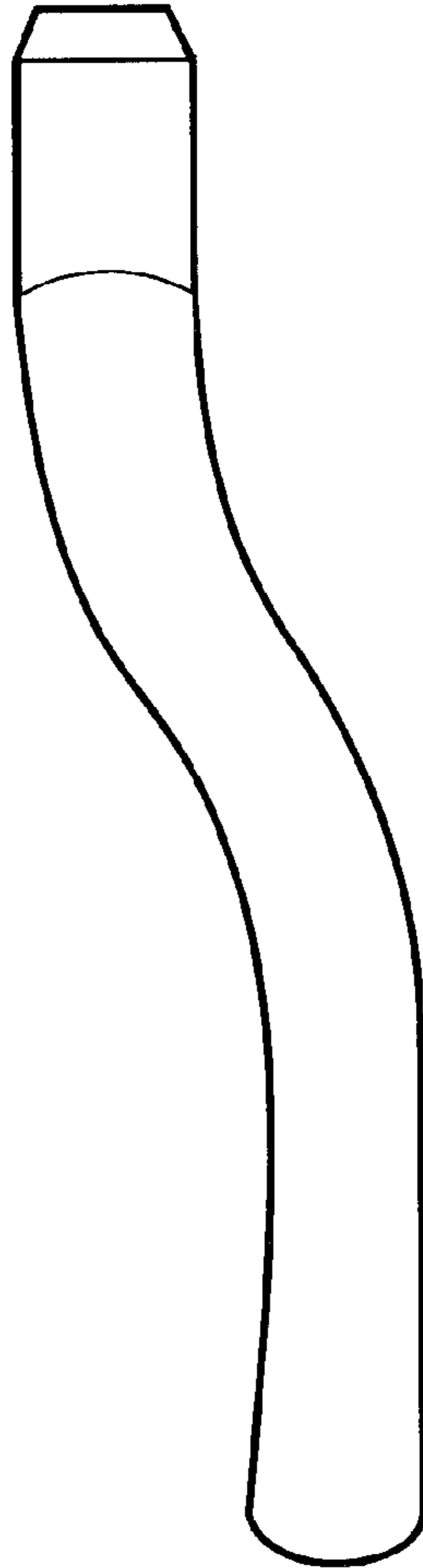

FIG. 3

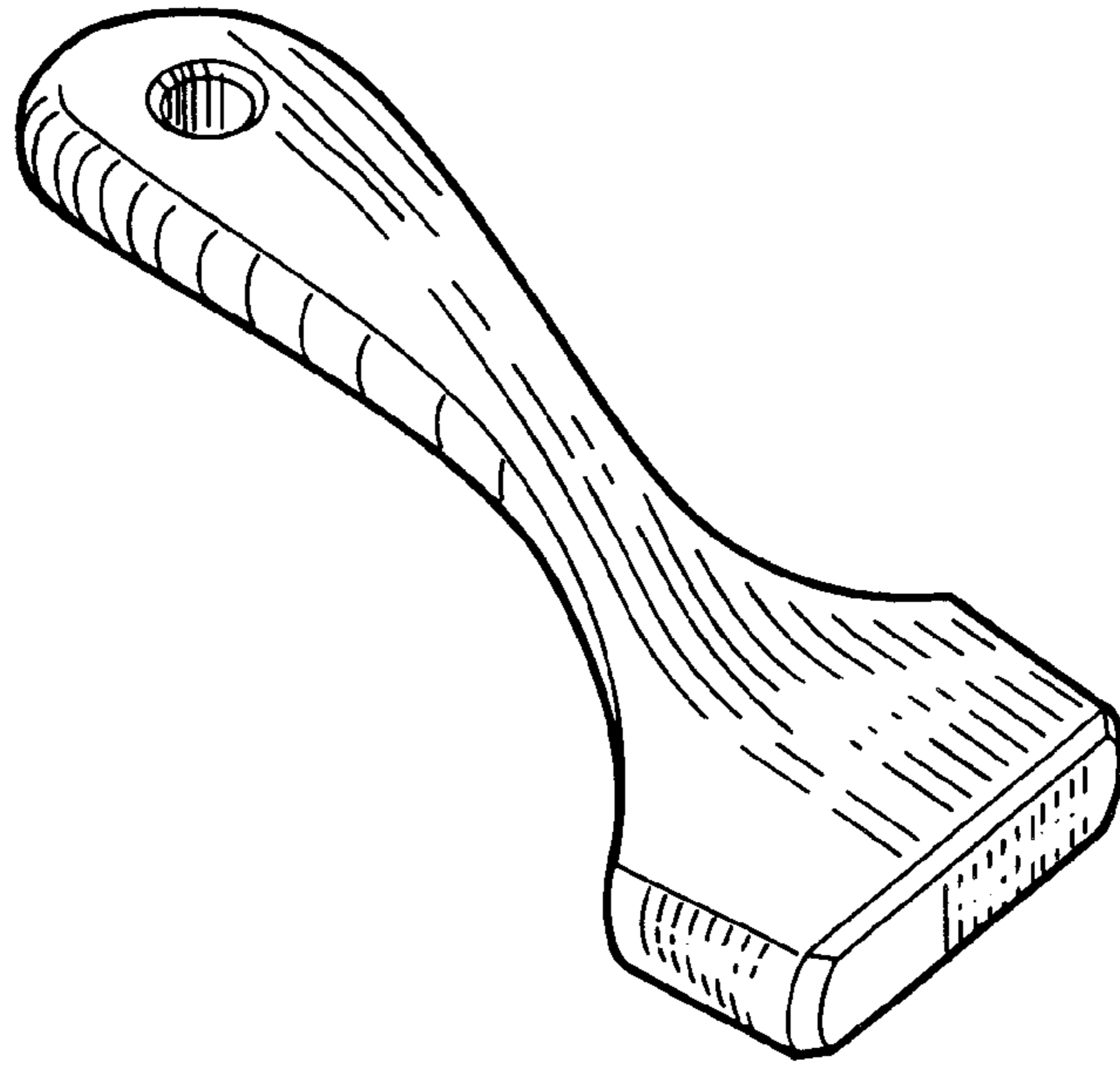

FIG. 4

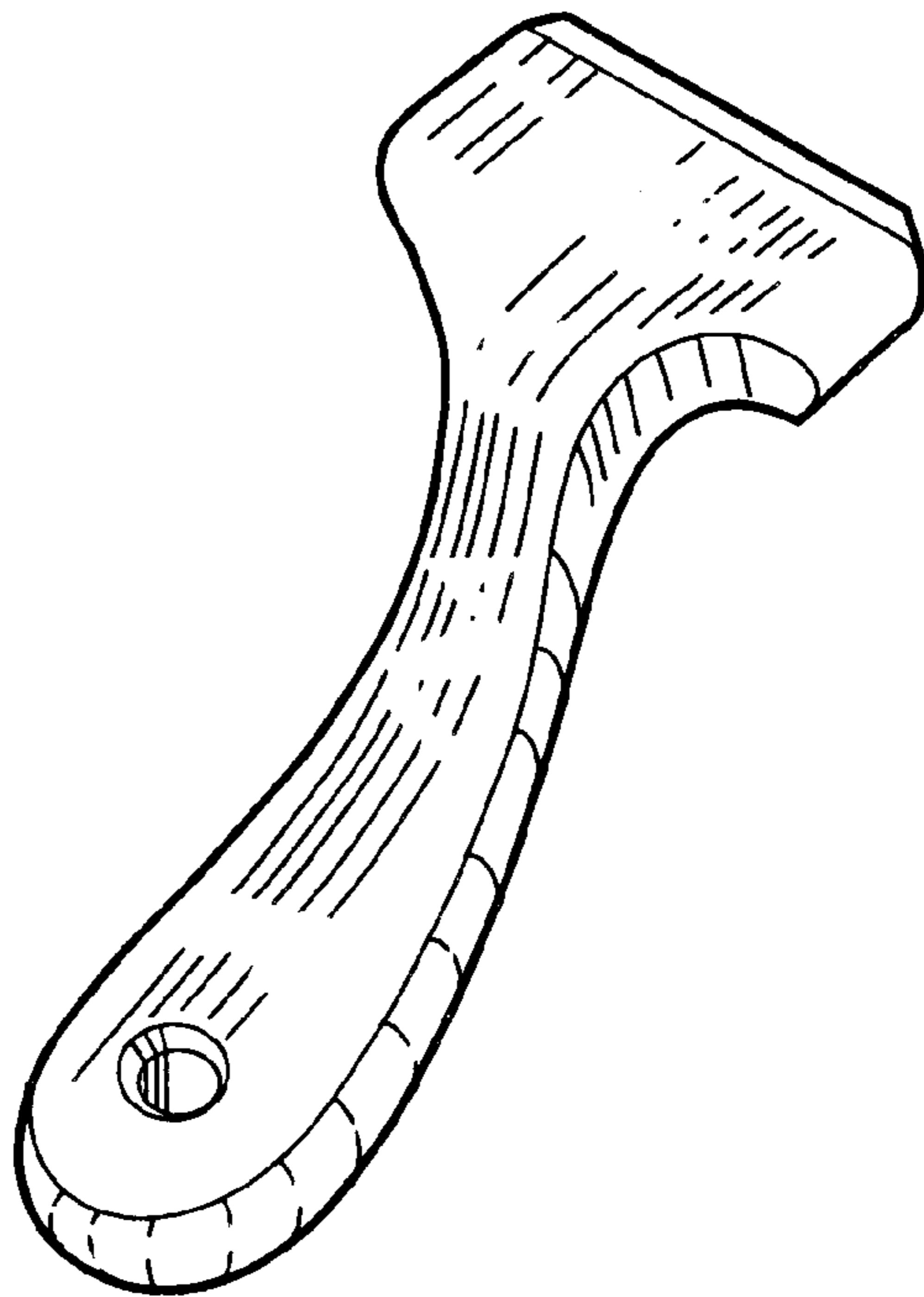

FIG. 5

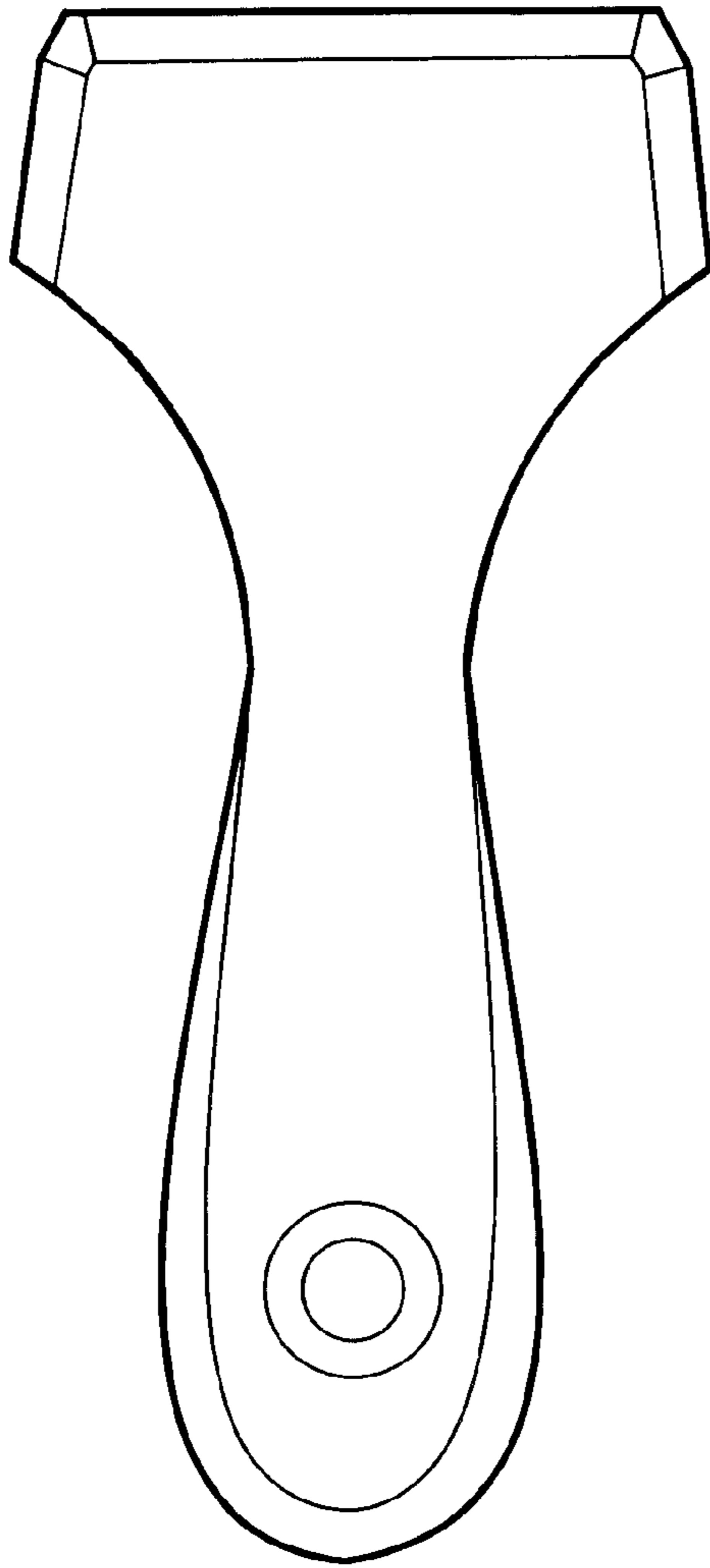

FIG. 6

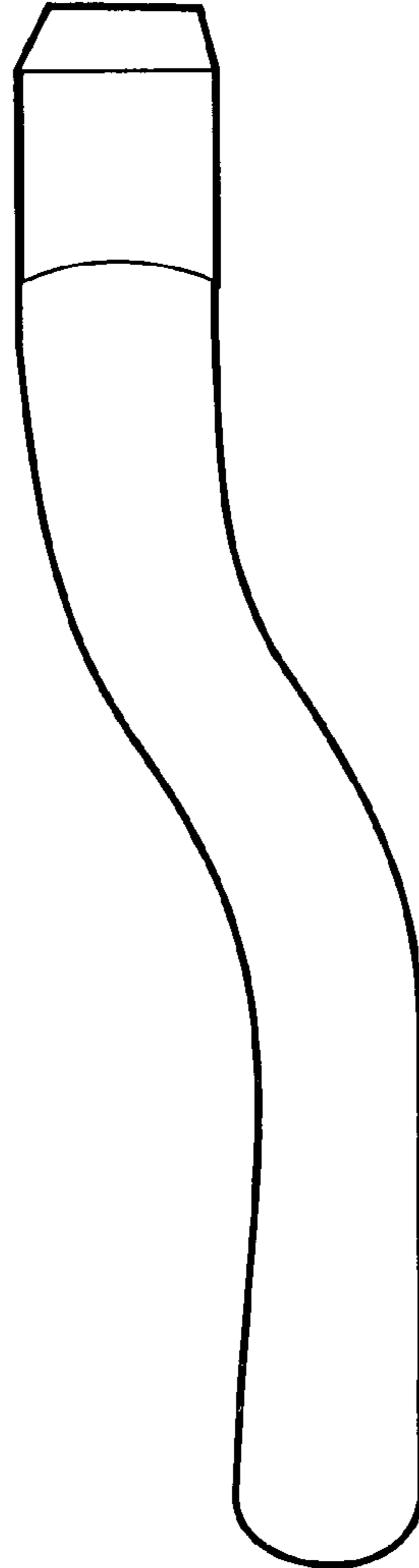

FIG. 7

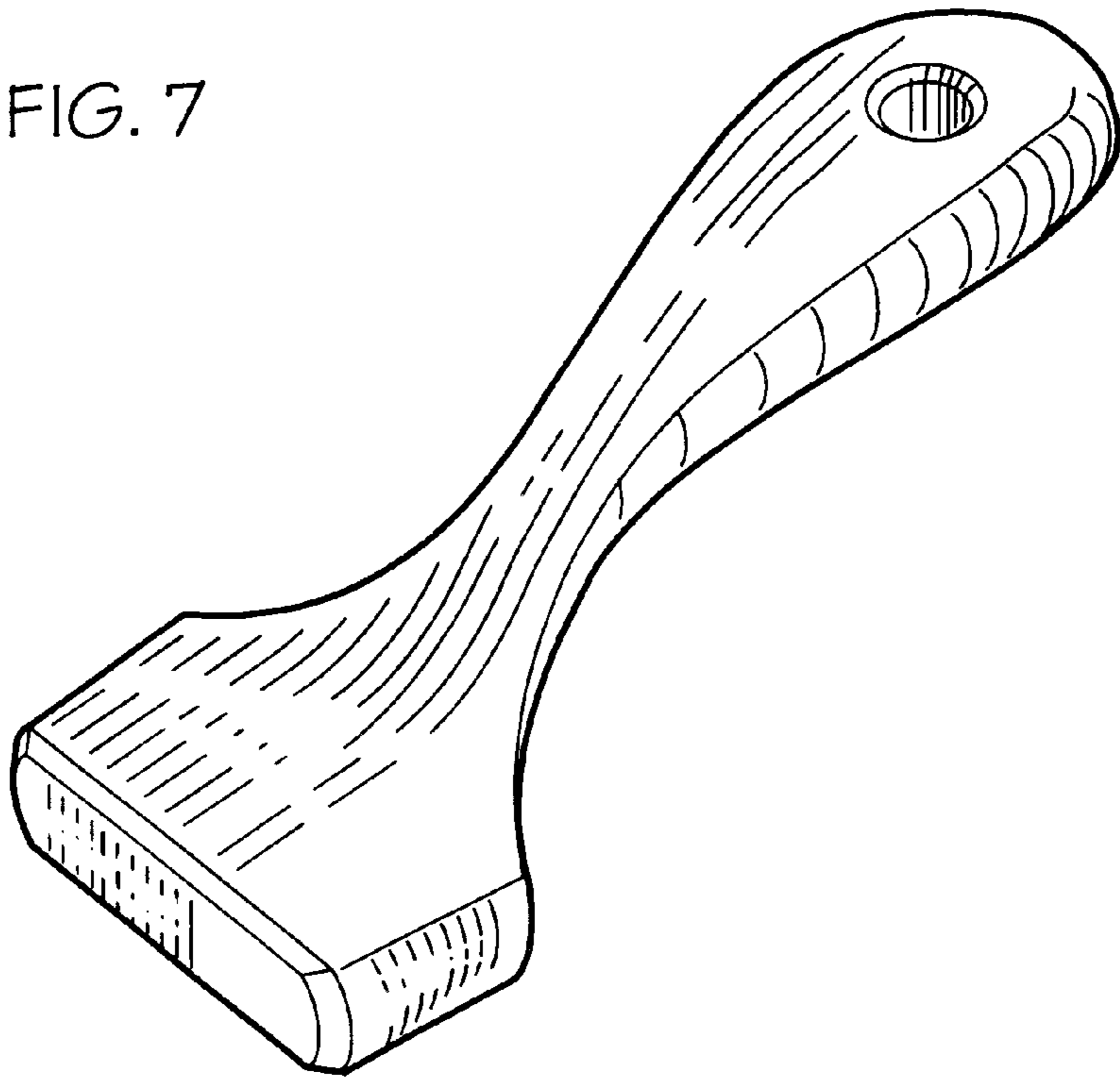

FIG. 8

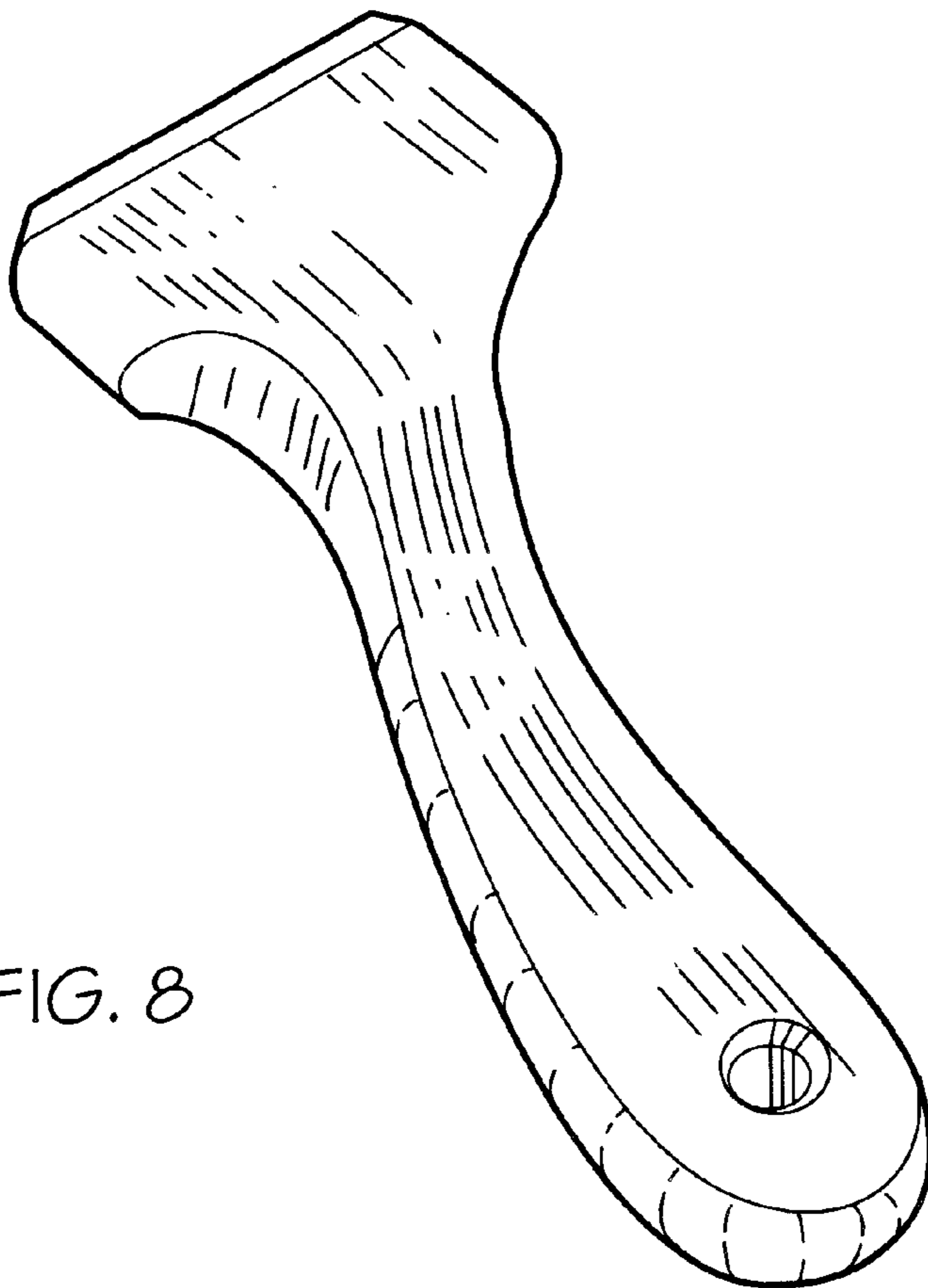

FIG. 9

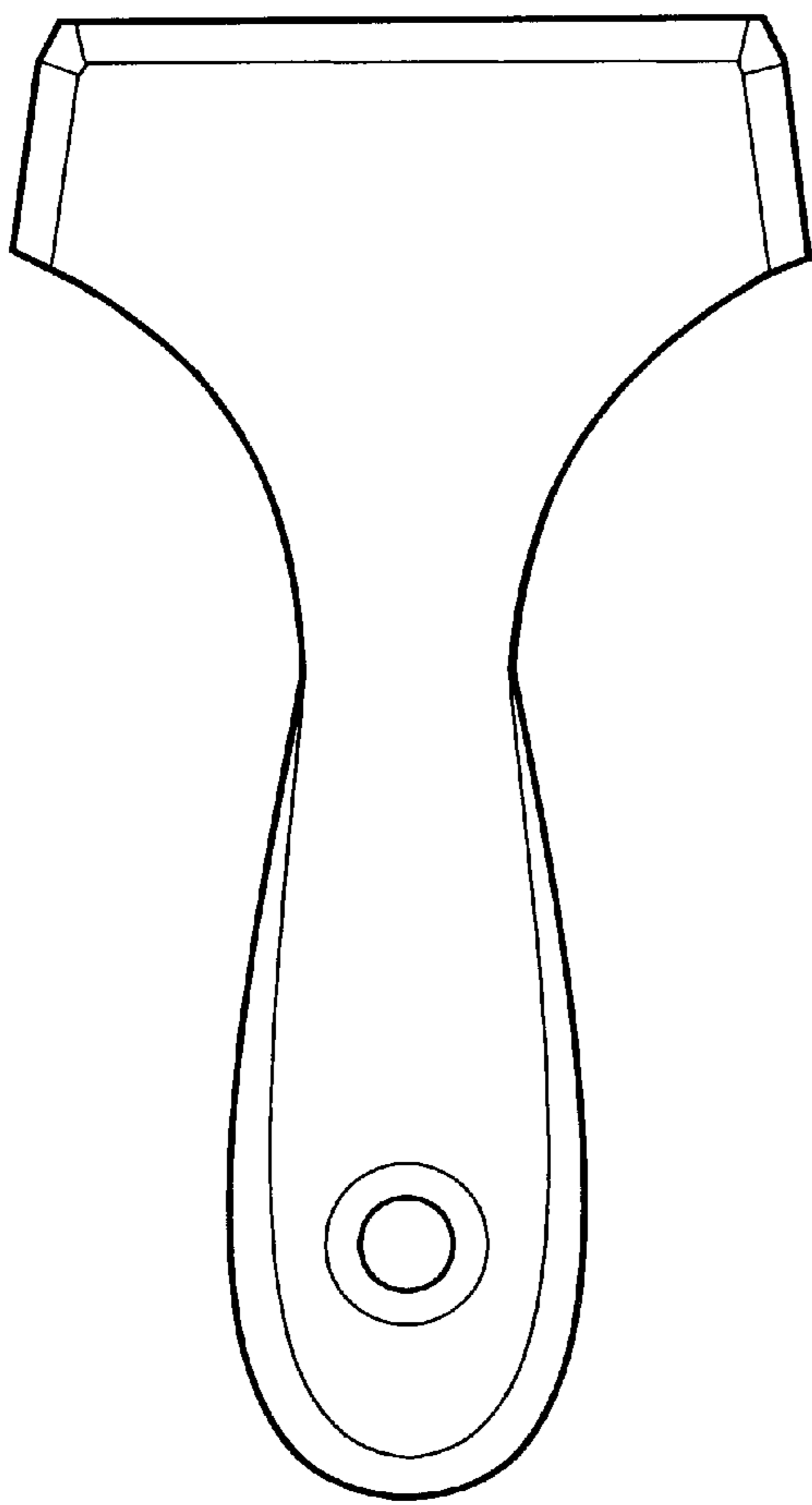

FIG.10



FIG. 11

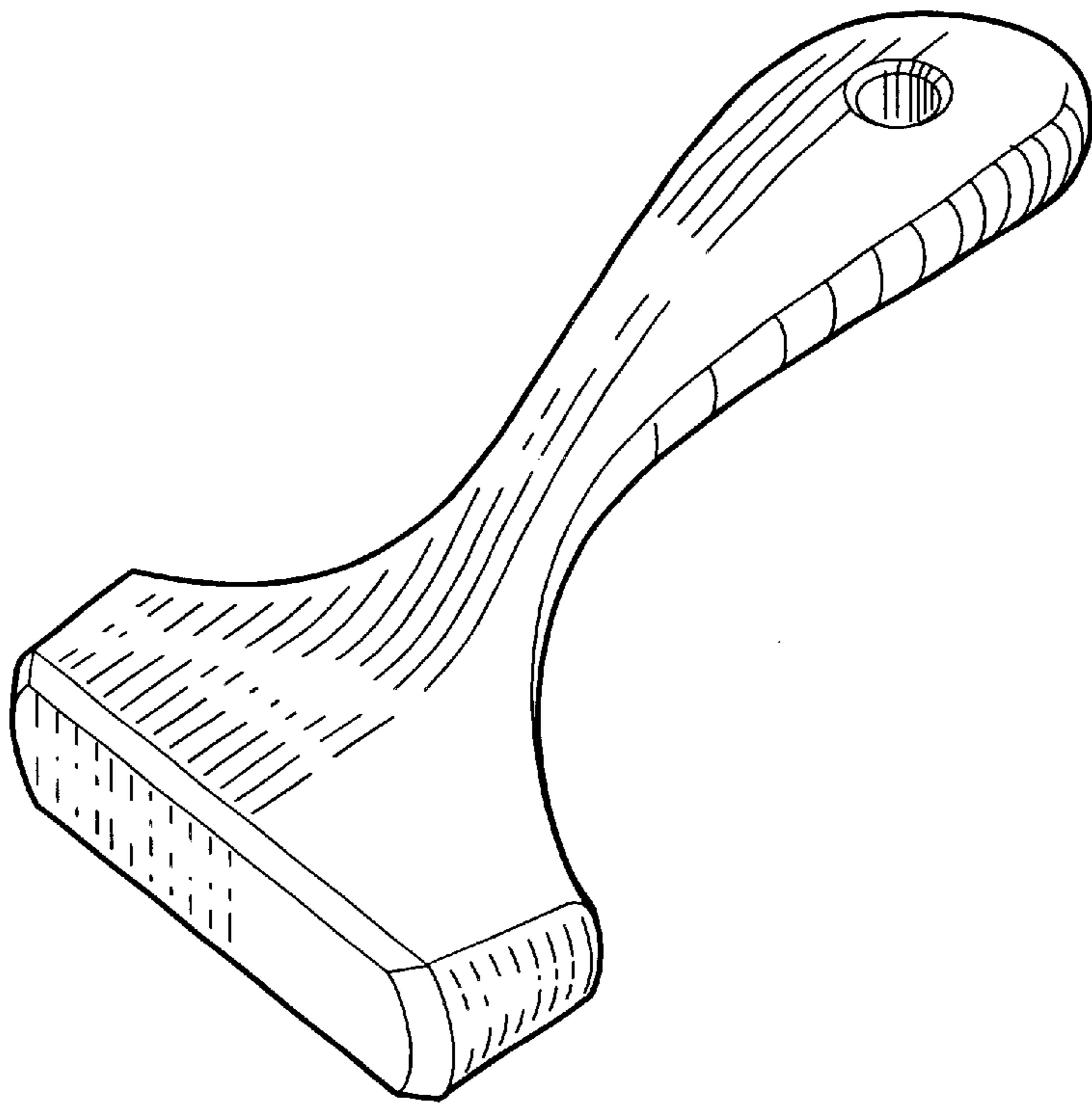

FIG-12

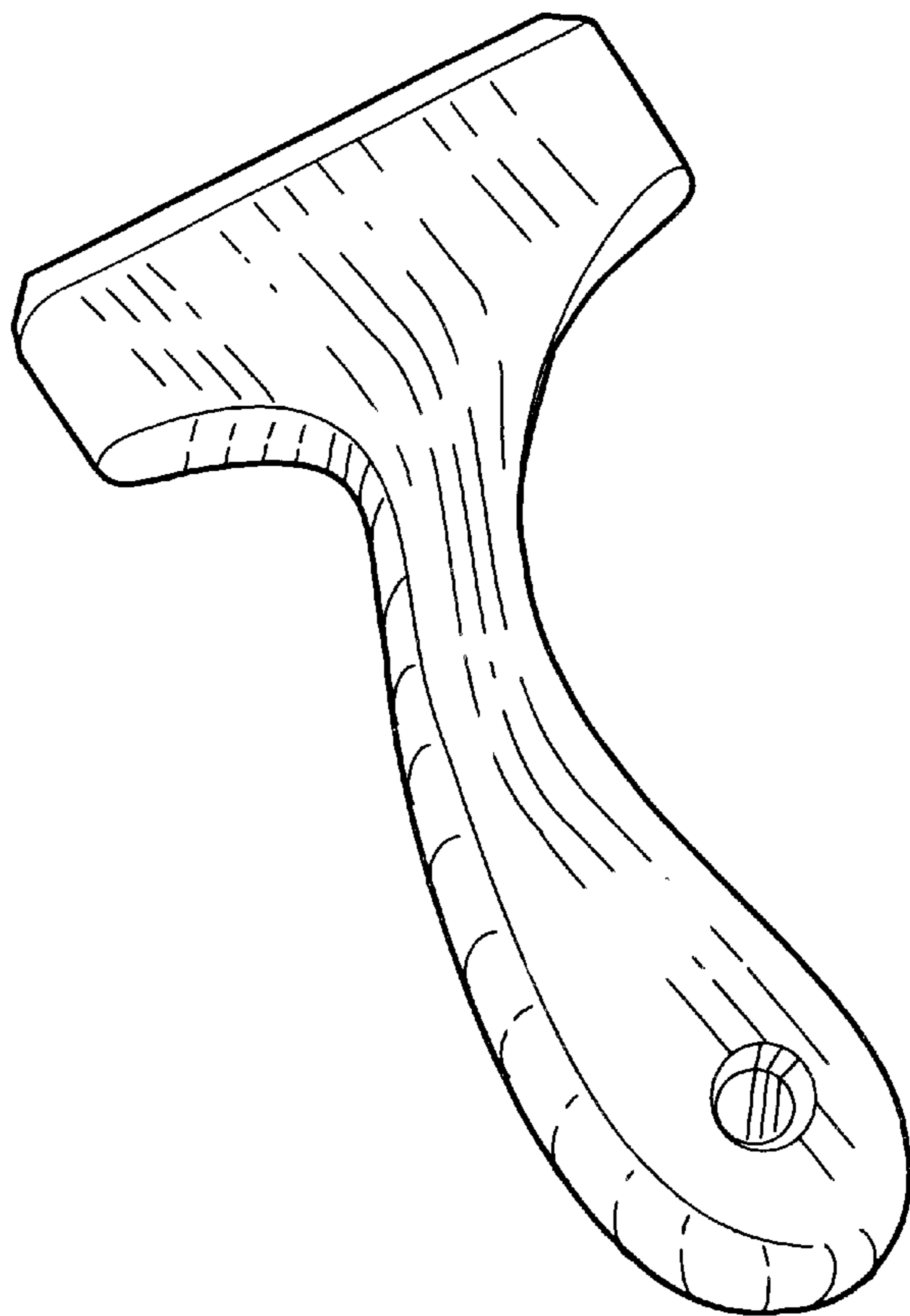

FIG. 13

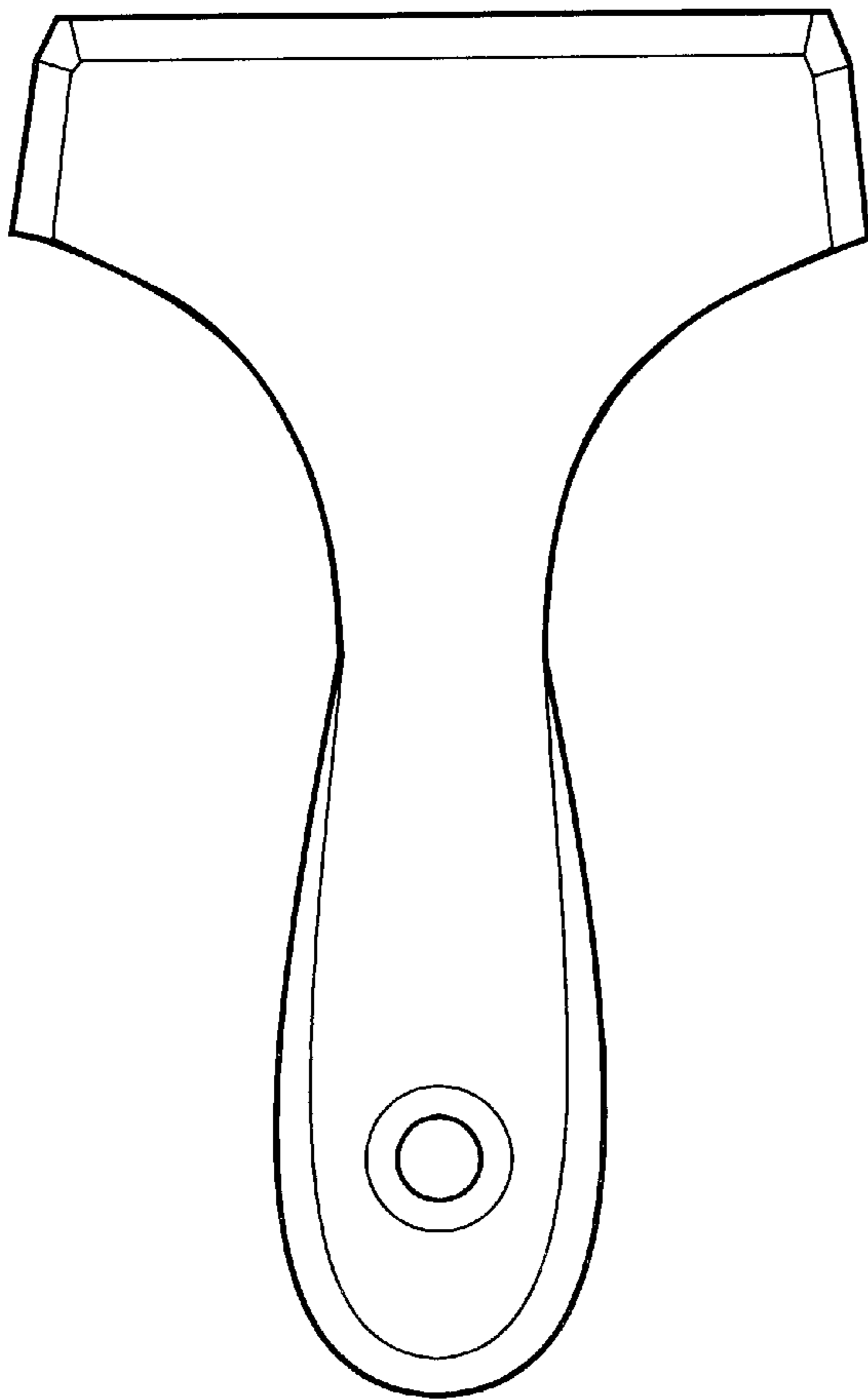

FIG. 14



FIG. 15

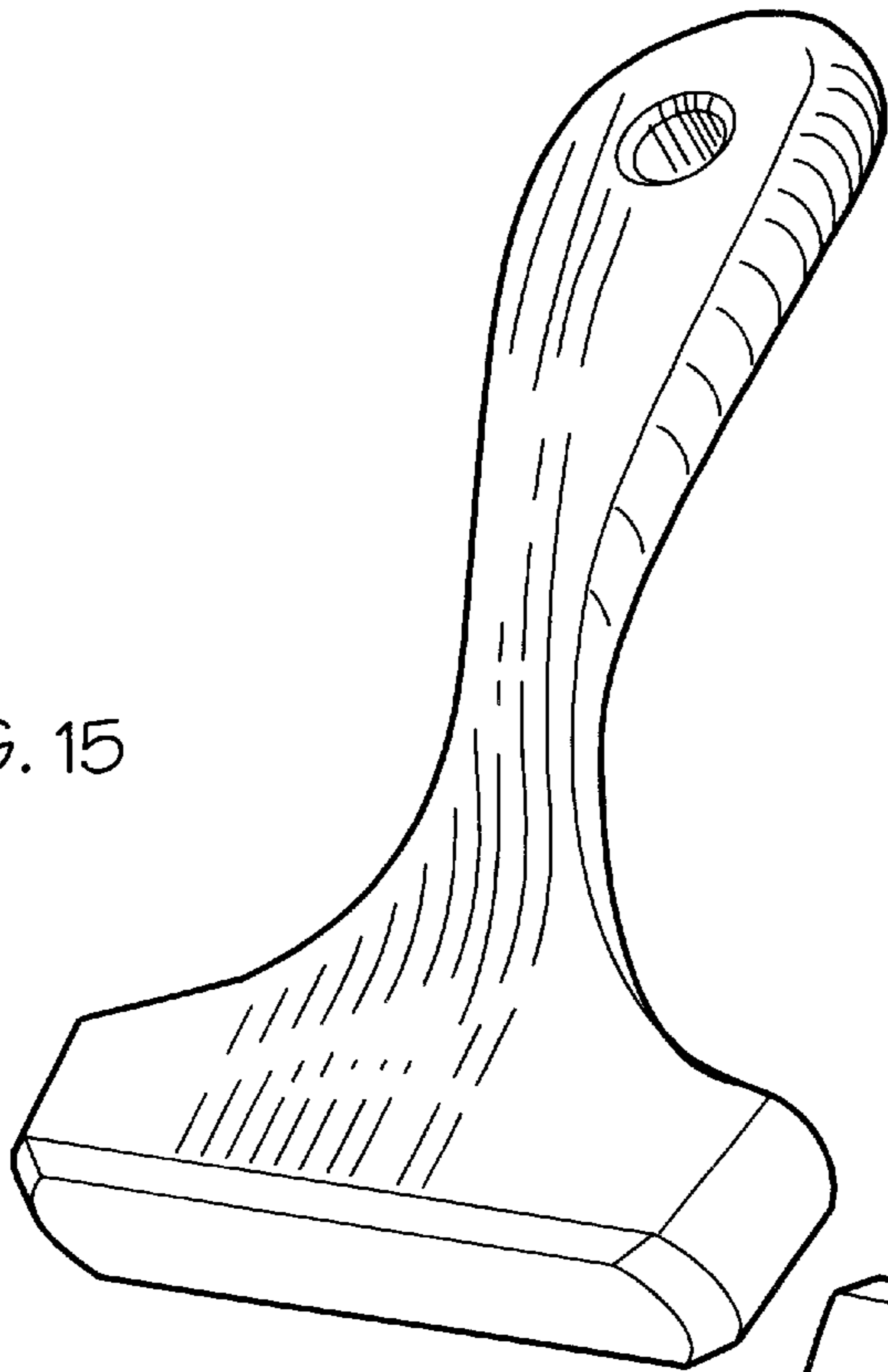

FIG. 16

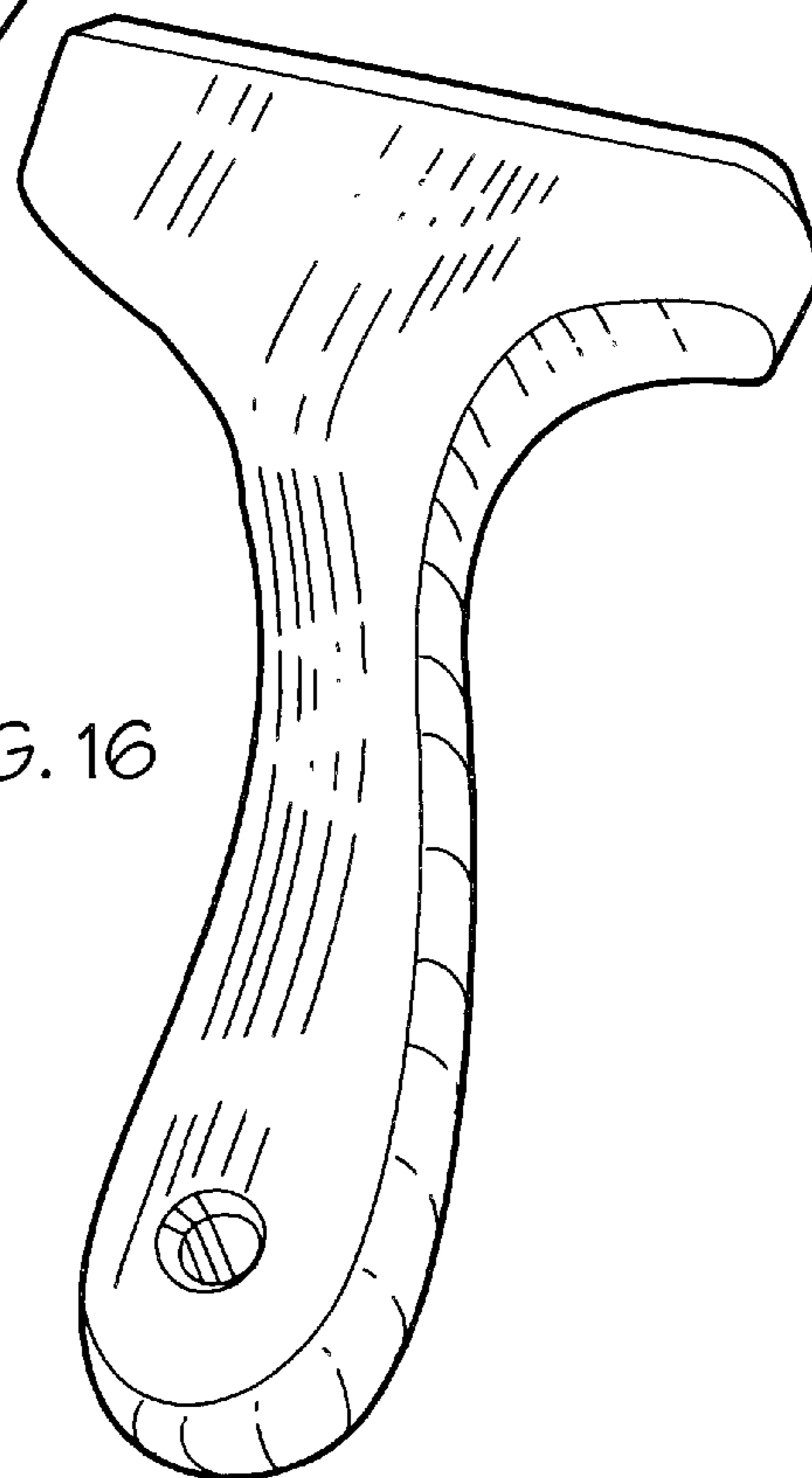

FIG. 17

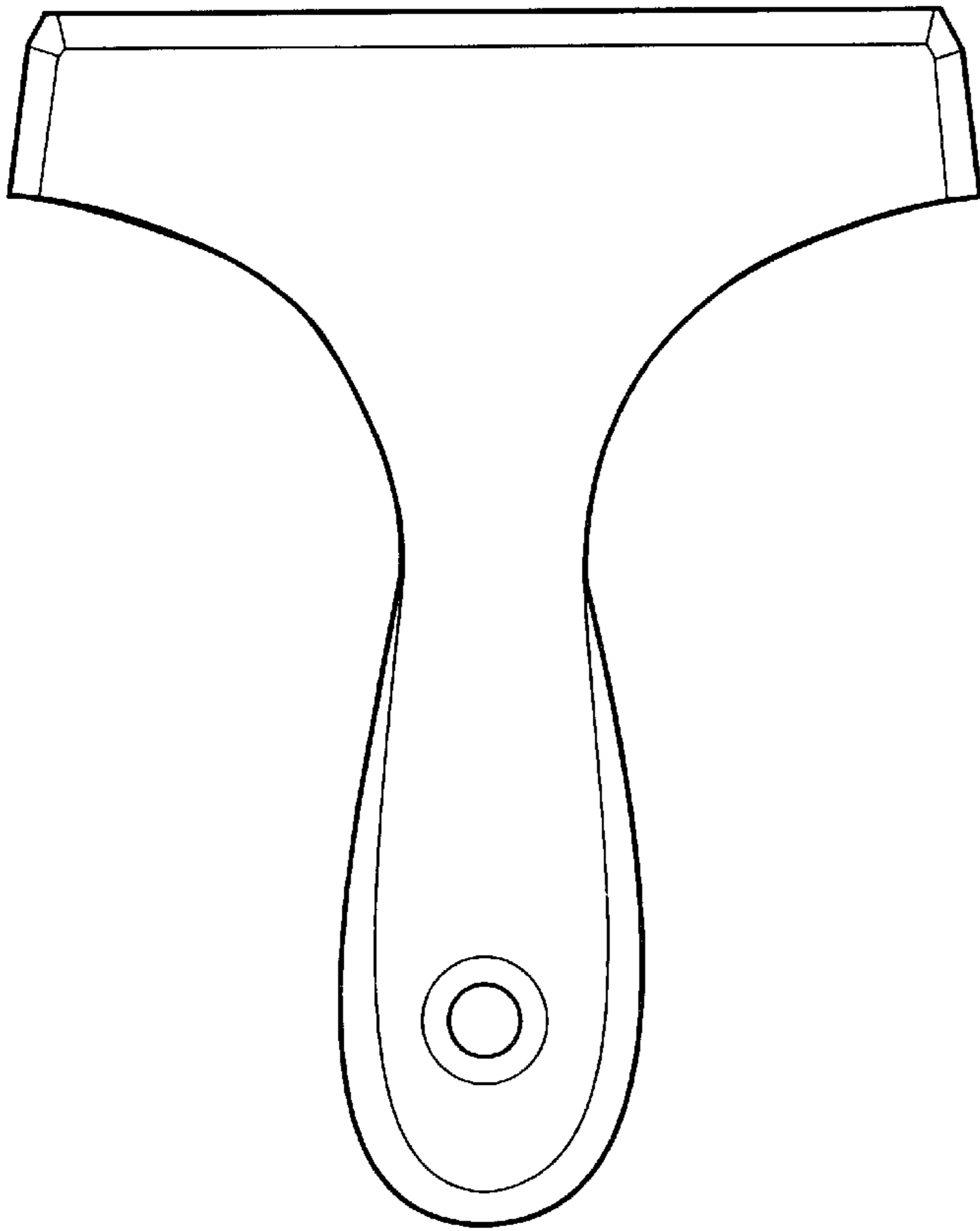

FIG. 18



FIG.19

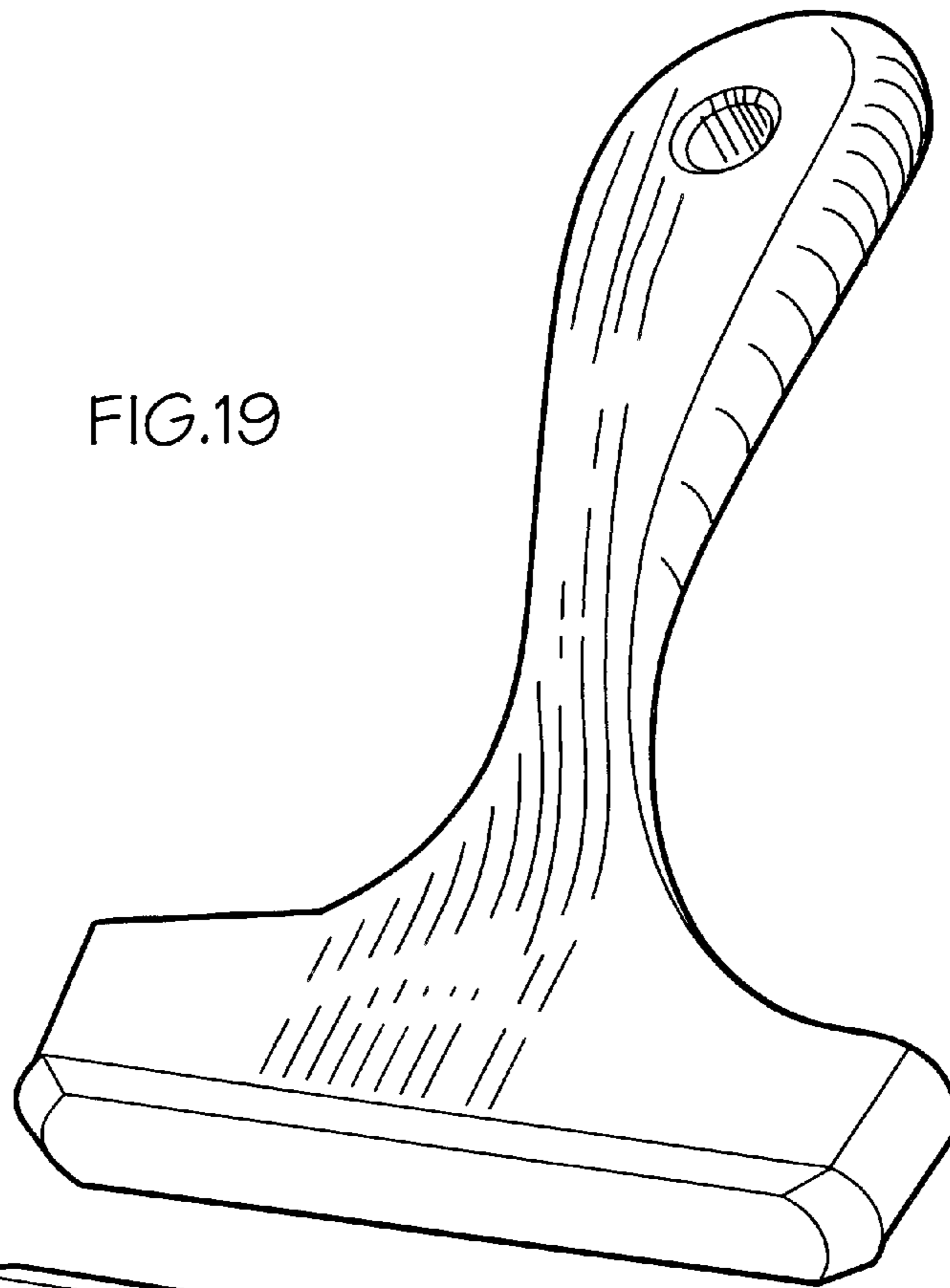

FIG. 20

