



US00D475198S

(12) **United States Design Patent**
Kim

(10) **Patent No.:** **US D475,198 S**

(45) **Date of Patent:** **** Jun. 3, 2003**

(54) **ARTICLE BAG**

(76) **Inventor:** **Ki hwan Kim**, 106-808 Jugong Apt.
Gyesan-dong, Gyeyang-ku, Incheon-city
(KR)

(**) **Term:** **14 Years**

(21) **Appl. No.:** **29/153,549**

(22) **Filed:** **Jan. 9, 2002**

(51) **LOC (7) Cl.** **03-01**

(52) **U.S. Cl.** **D3/306**

(58) **Field of Search** D3/201, 215, 226,
D3/229, 303, 306, 315, 323, 328; 248/95,
99; 220/476, 480, 483, 485, 493, 495, 640,
641, 649, 656-659; D32/36; 383/11, 22,
23, 33, 100, 117, 121.1

(56) **References Cited**

U.S. PATENT DOCUMENTS

1,077,959 A * 11/1913 Gregory et al. 383/117
2,064,696 A * 12/1936 Smith 248/99

D147,587 S * 9/1947 Kaplan D32/36
4,949,842 A * 8/1990 Mokiao, II 383/117
5,092,682 A * 3/1992 Fenick 383/22
6,371,642 B1 * 4/2002 Nelson et al. 383/23

* cited by examiner

Primary Examiner—Louis S. Zarfes

Assistant Examiner—Deanne Levy

(74) *Attorney, Agent, or Firm*—Pendorf & Cutliff

(57) **CLAIM**

The ornamental design for an article bag, as shown and described.

DESCRIPTION

FIG. 1 is an elevated perspective view of an article bag
FIG. 2 is a front view of the bag of FIG. 1
FIG. 3 is a back view of the bag of FIG. 1
FIG. 4 is a left side view of the bag of FIG. 1
FIG. 5 is a right side view of the bag of FIG. 1
FIG. 6 is a top plan view of the bag of FIG. 1; and,
FIG. 7 is a bottom plan view of the bag of FIG. 1.

1 Claim, 5 Drawing Sheets

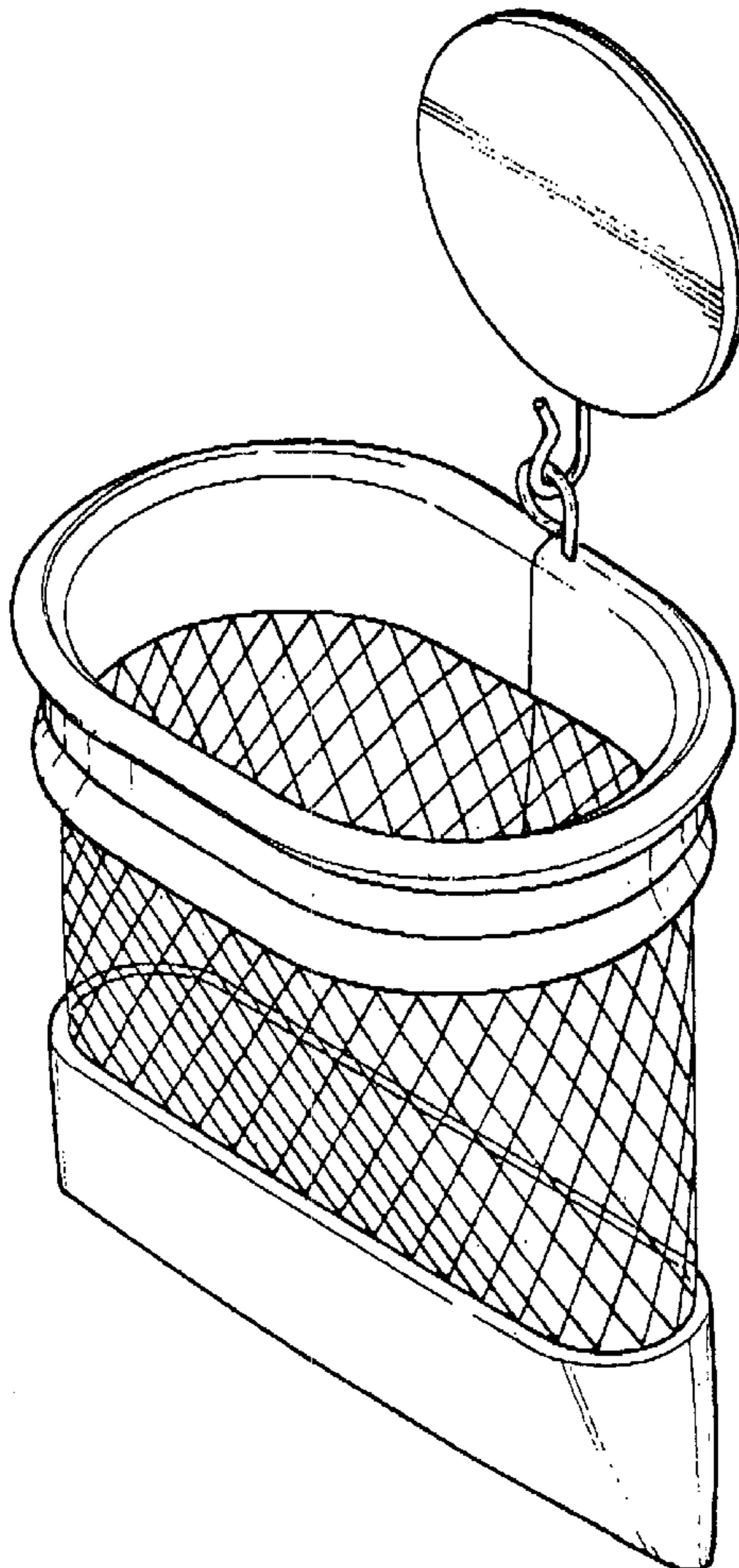

FIG. 1

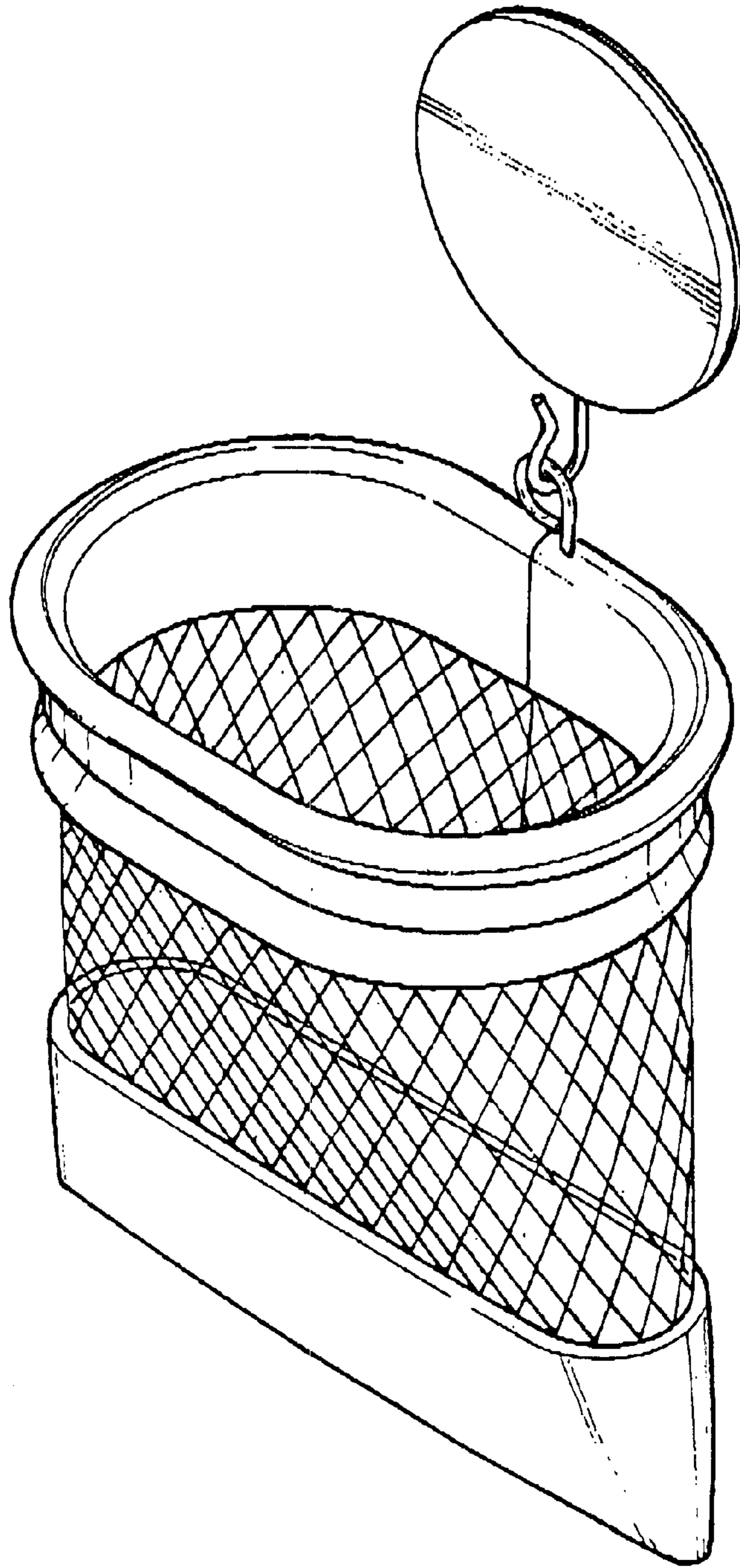

FIG . 2

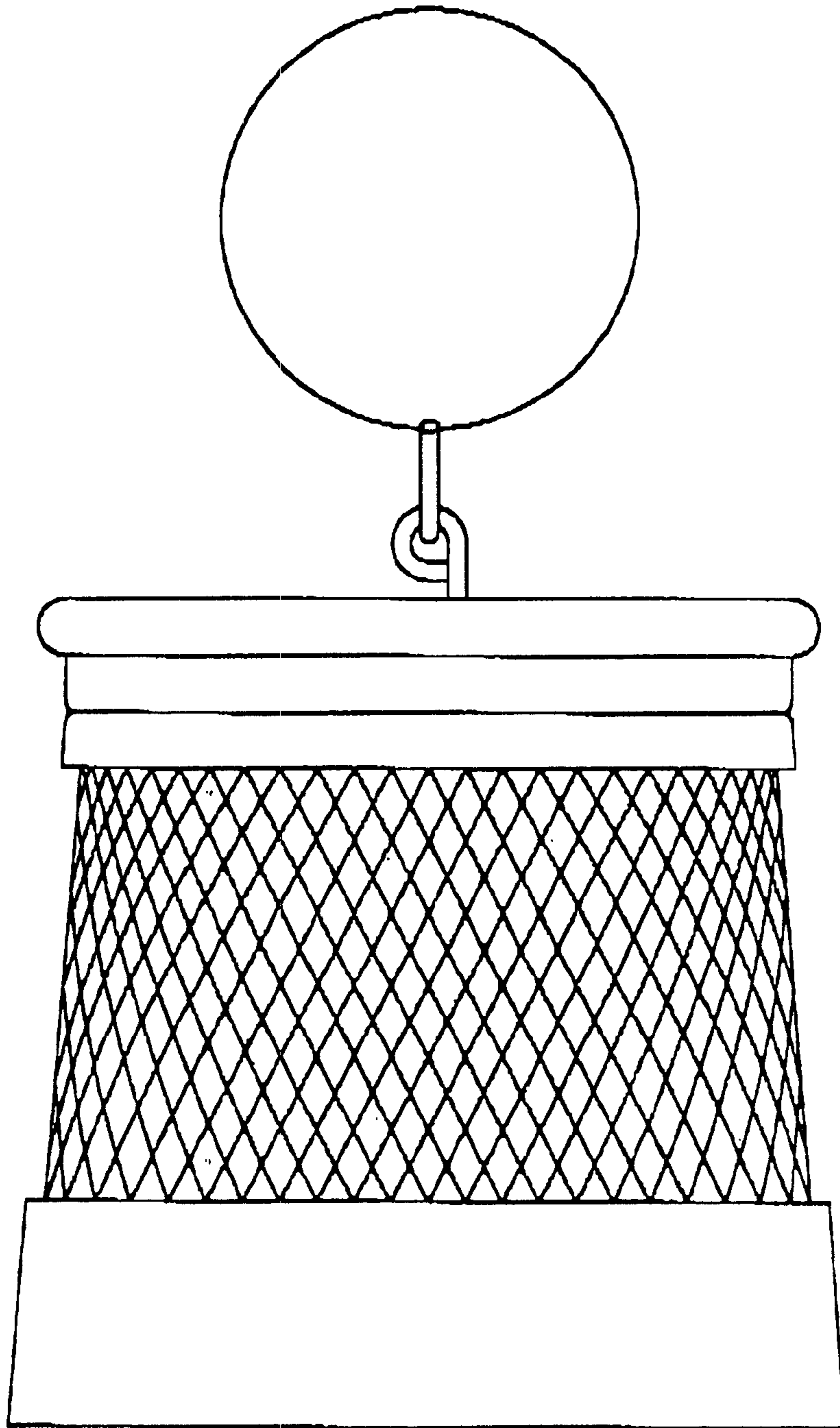

FIG . 3

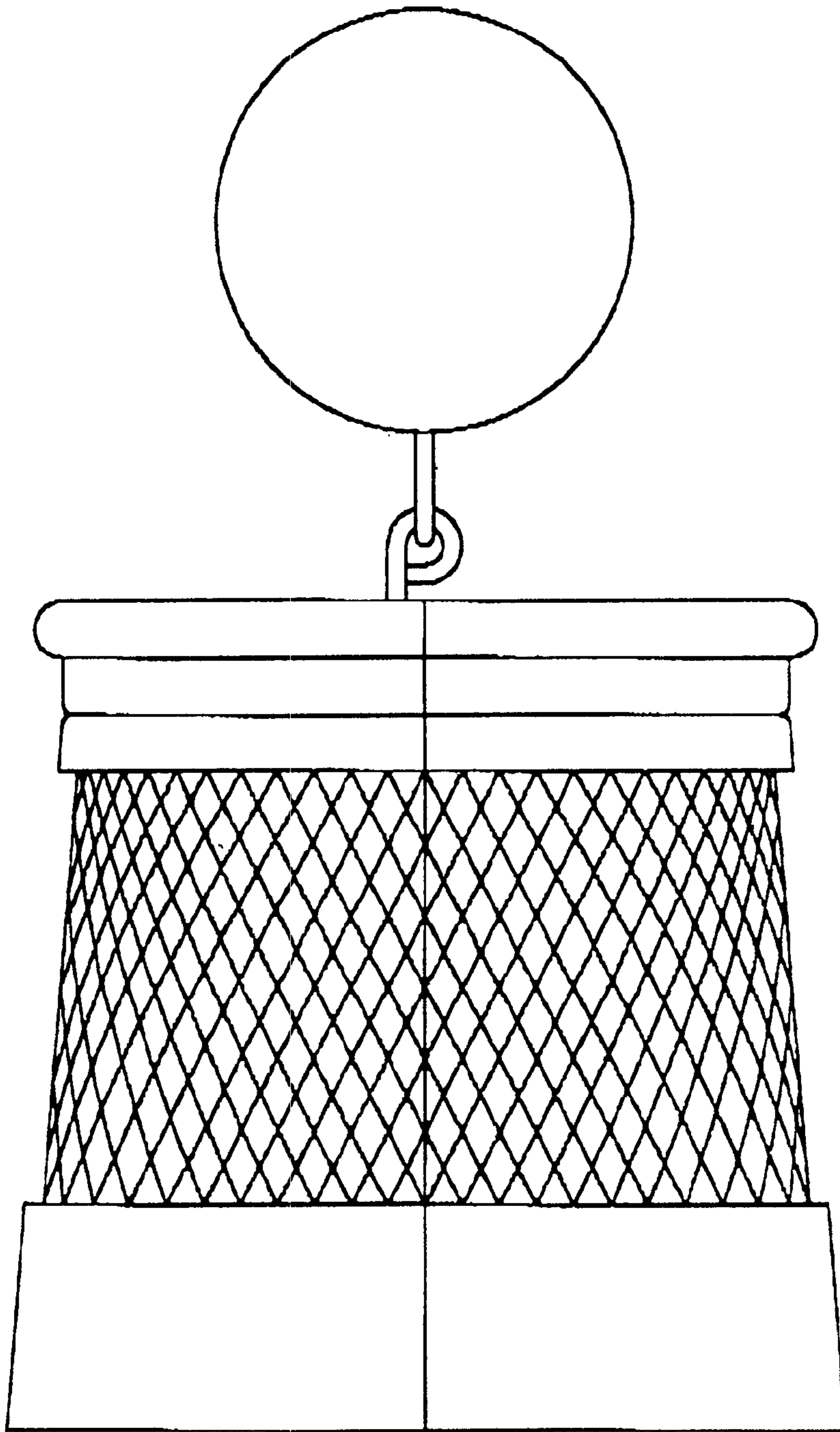

FIG . 4

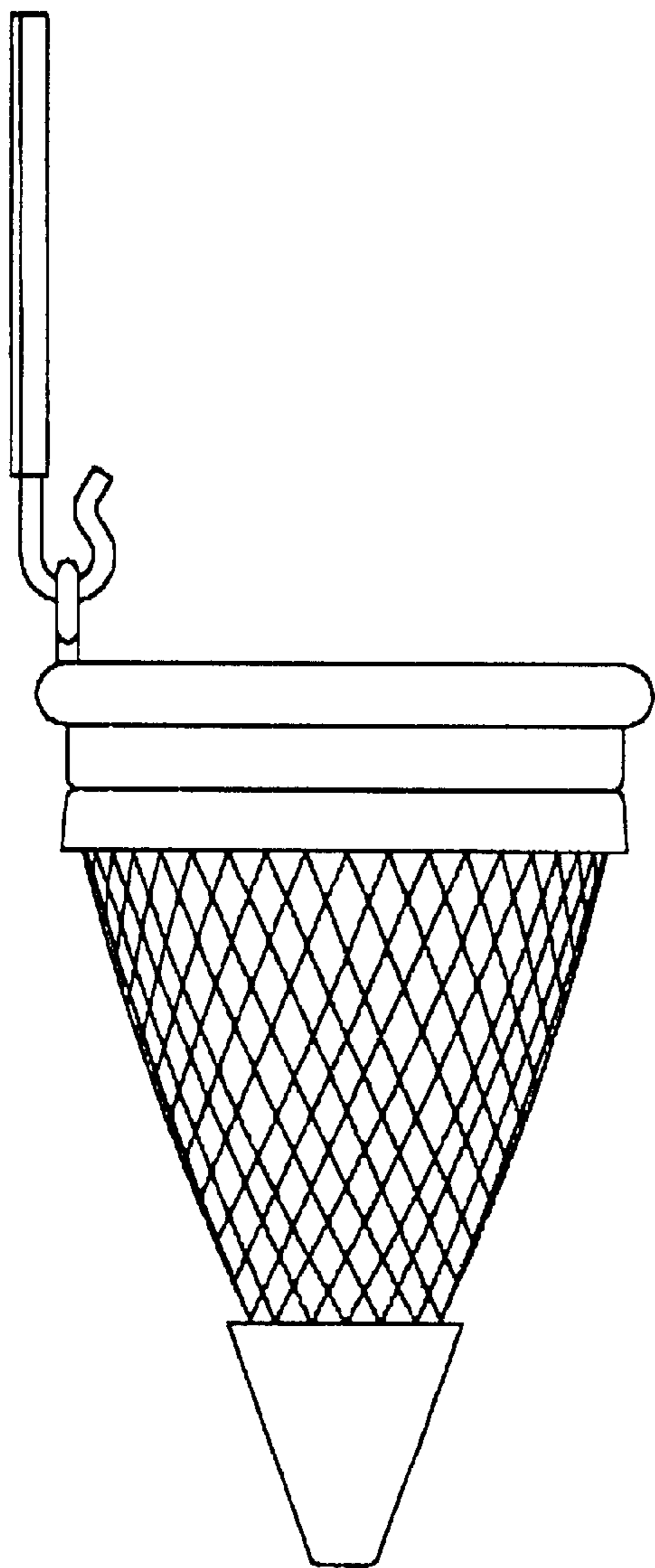

FIG . 5

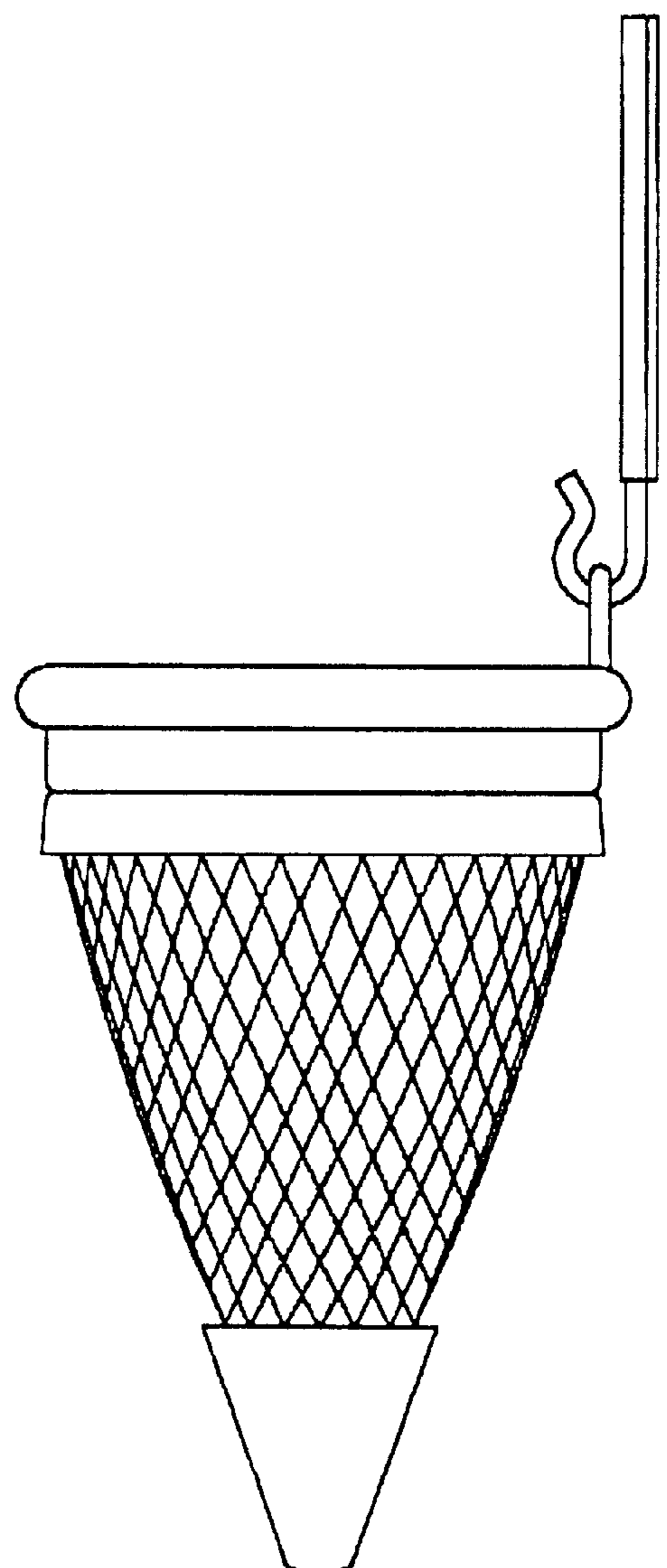

FIG . 6

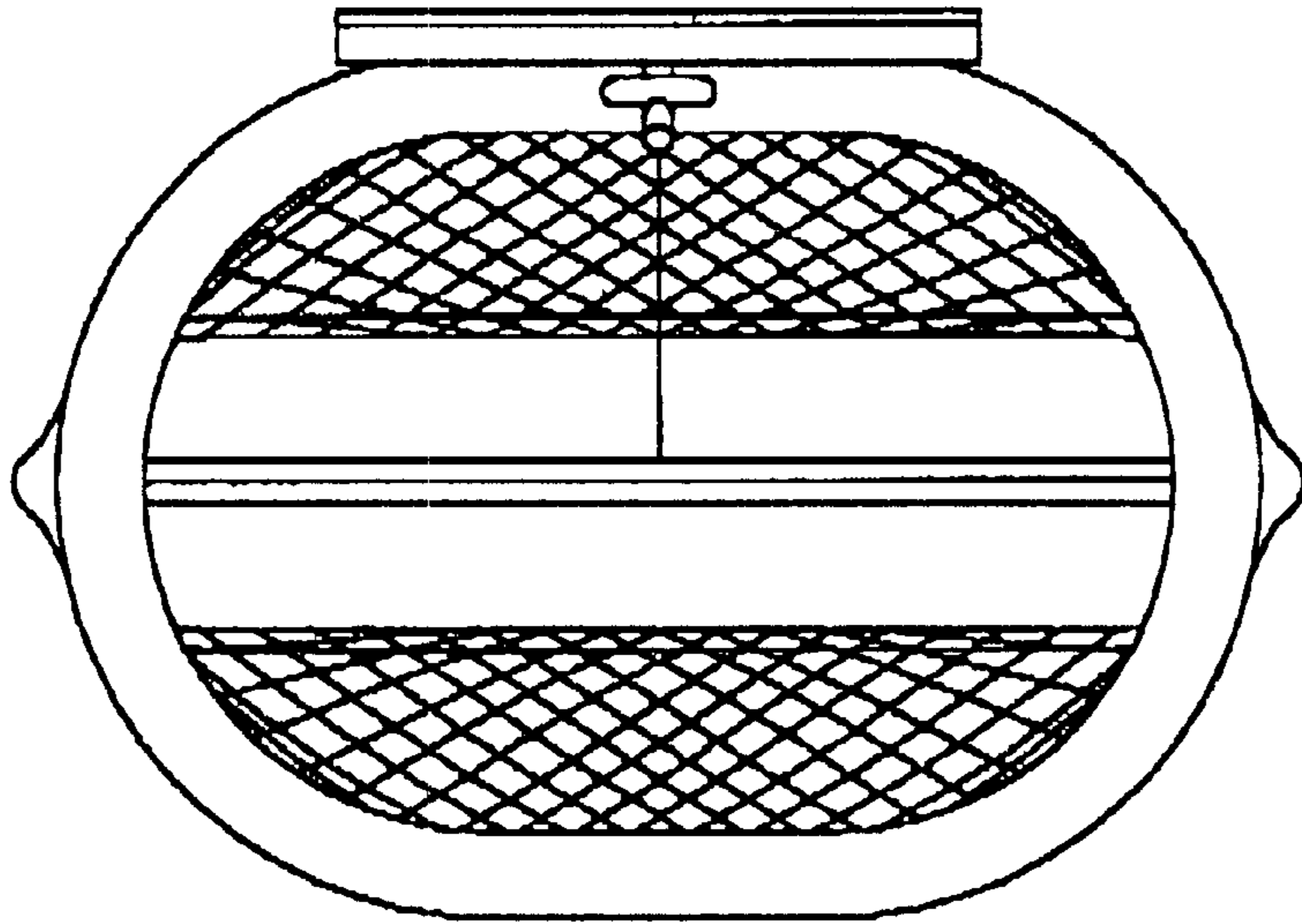

FIG . 7

