



US00D475043S

(12) **United States Design Patent**  
**Lehtonen**

(10) **Patent No.:** **US D475,043 S**

(45) **Date of Patent:** **\*\* May 27, 2003**

(54) **FRONT COVER FOR A HANDSET**

(75) **Inventor:** **Jarmo Lehtonen, Littoinen (FI)**

(73) **Assignee:** **Nokia Corporation, Espoo (FI)**

(\*\*) **Term:** **14 Years**

(21) **Appl. No.:** **29/158,858**

(22) **Filed:** **Apr. 12, 2002**

(30) **Foreign Application Priority Data**

Oct. 12, 2001 (FI) ..... M20010689

(51) **LOC (7) Cl.** ..... **14-03**

(52) **U.S. Cl.** ..... **D14/248**

(58) **Field of Search** ..... D14/137, 138,  
D14/218, 147-148, 247-248, 144, 341-347;  
379/433.01-433.13, 419, 434, 428.01-428.04,  
420.01-420.04, 440; 455/550-575, 90;  
D21/517

(56) **References Cited**

**U.S. PATENT DOCUMENTS**

5,151,946	A	*	9/1992	Martensson	.....	455/550
D385,554	S	*	10/1997	Nuovo et al.	.....	D14/138
D385,875	S	*	11/1997	Harris et al.	.....	D14/138
D390,555	S	*	2/1998	Finke-Anlauff	.....	D14/138
D407,399	S	*	3/1999	Frye et al.	.....	D14/138
D408,813	S	*	4/1999	Prior	.....	D14/138
D411,205	S	*	6/1999	Frye et al.	.....	D14/250
D412,710	S	*	8/1999	Nuovo	.....	D14/250
D413,325	S	*	8/1999	Lee	.....	D14/138
5,956,625	A	*	9/1999	Hansen et al.	.....	455/90
6,014,552	A	*	1/2000	Aiken et al.	.....	455/90
D422,597	S	*	4/2000	Finkbeiner	.....	D14/248
D425,074	S	*	5/2000	Frye et al.	.....	D14/248
D425,904	S		5/2000	Frye et al.	.....	
D427,171	S	*	6/2000	Frye et al.	.....	D14/138
D429,491	S	*	8/2000	Finkbeiner	.....	D14/248
D430,151	S		8/2000	Frye et al.	.....	
6,151,485	A	*	11/2000	Crisp	.....	455/90

6,208,874	B1	*	3/2001	Rudisill et al.	.....	455/550
D440,951	S	*	4/2001	Kolinen	.....	D14/138
D443,607	S	*	6/2001	Kolinen	.....	D14/248
6,246,862	B1	*	6/2001	Grivas et al.	.....	455/90
D445,409	S	*	7/2001	Segers	.....	D14/138
D448,022	S	*	9/2001	Higashi et al.	.....	D14/248
D451,079	S	*	11/2001	Ali	.....	D14/138
D453,150	S	*	1/2002	Murray	.....	D14/138
D455,137	S	*	4/2002	Wang	.....	D14/138
6,370,362	B1	*	4/2002	Hansen et al.	.....	455/90
D459,327	S	*	6/2002	Ali	.....	D14/138
D461,467	S	*	8/2002	Ruohonen	.....	D14/248
6,463,262	B1	*	10/2002	Johnson et al.	.....	455/90
D466,096	S	*	11/2002	Takada	.....	D14/138

**OTHER PUBLICATIONS**

Hague Database Search Page [http://  
guest:guest@ipdl.wipo.int/en/search/hag/  
search-bool2.html], Document DM/059670, Apr. 12, 2002.\*

\* cited by examiner

*Primary Examiner*—Jeffrey Asch  
(74) *Attorney, Agent, or Firm*—Banner & Witcoff, Ltd.

(57) **CLAIM**

The ornamental design for a front cover for a handset, as shown and described.

**DESCRIPTION**

FIG. 1 is a bottom plan view of a front cover for a handset showing my new design;  
FIG. 2 is a right side view thereof;  
FIG. 3 is a front view thereof;  
FIG. 4 is a left side view thereof;  
FIG. 5 is a top plan view thereof;  
FIG. 6 is a perspective front view thereof;  
FIG. 7 is a front view thereof with the cover in the open position; and,  
FIG. 8 is a perspective front view thereof with the cover in the open position.

**1 Claim, 4 Drawing Sheets**

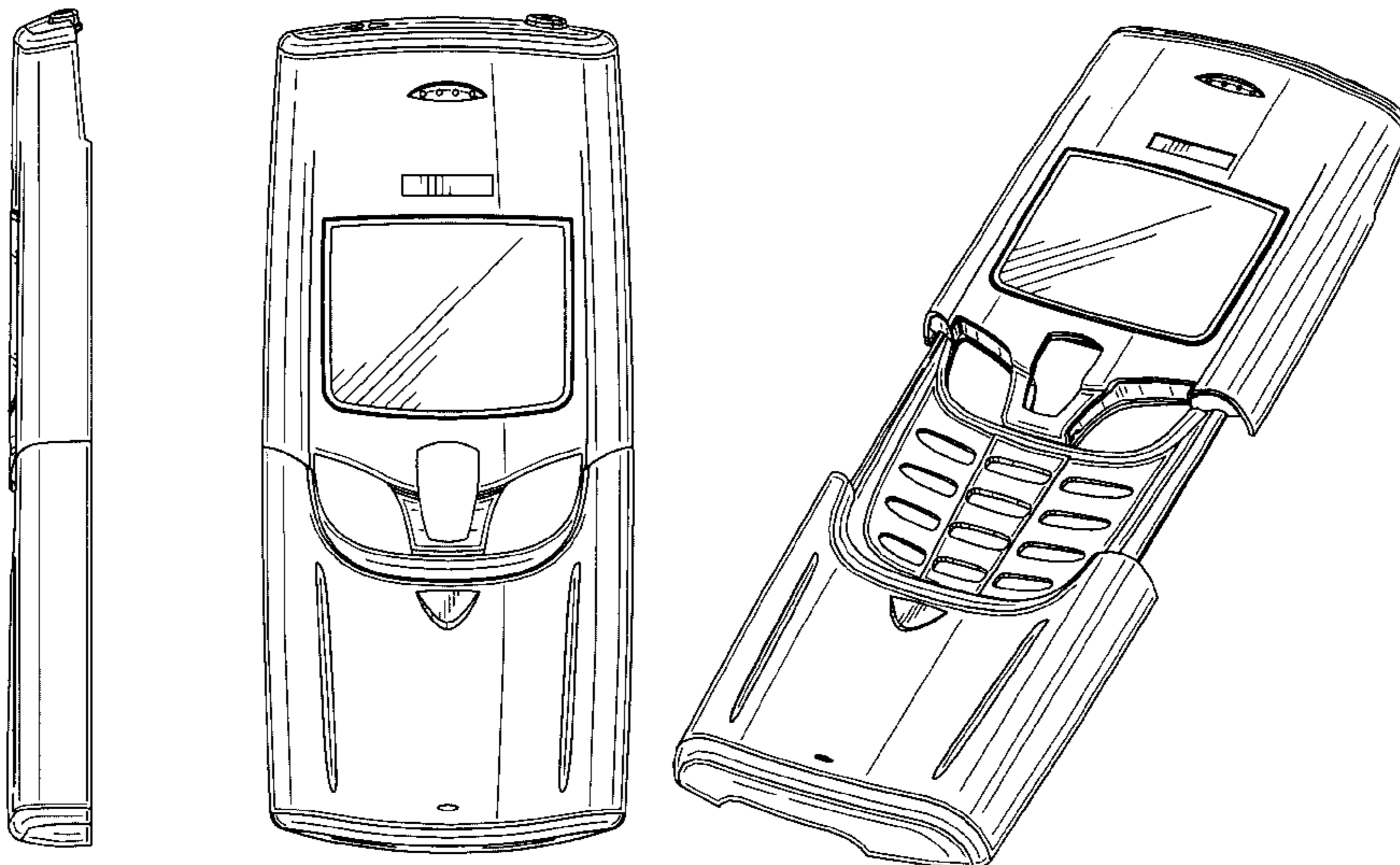

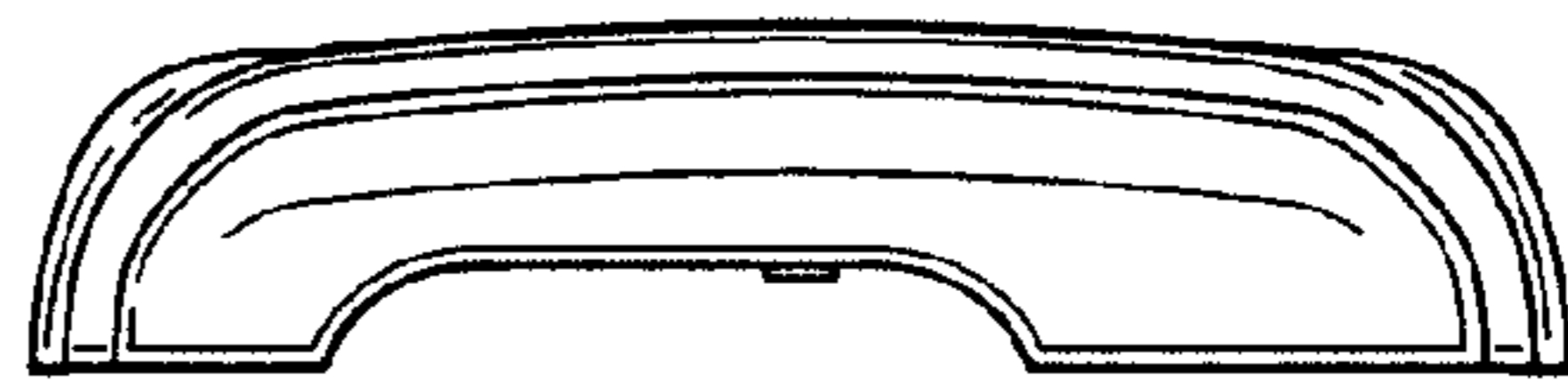

FIG. 1

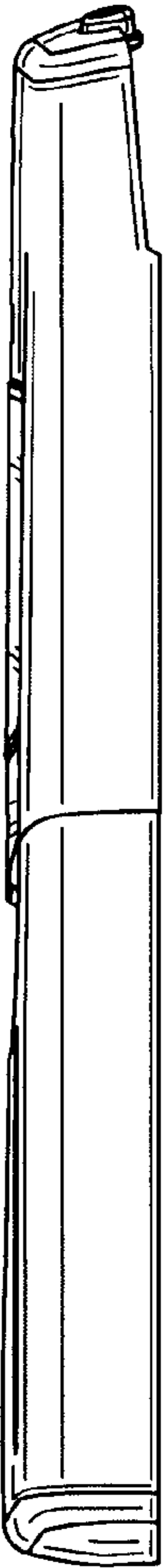

FIG. 2

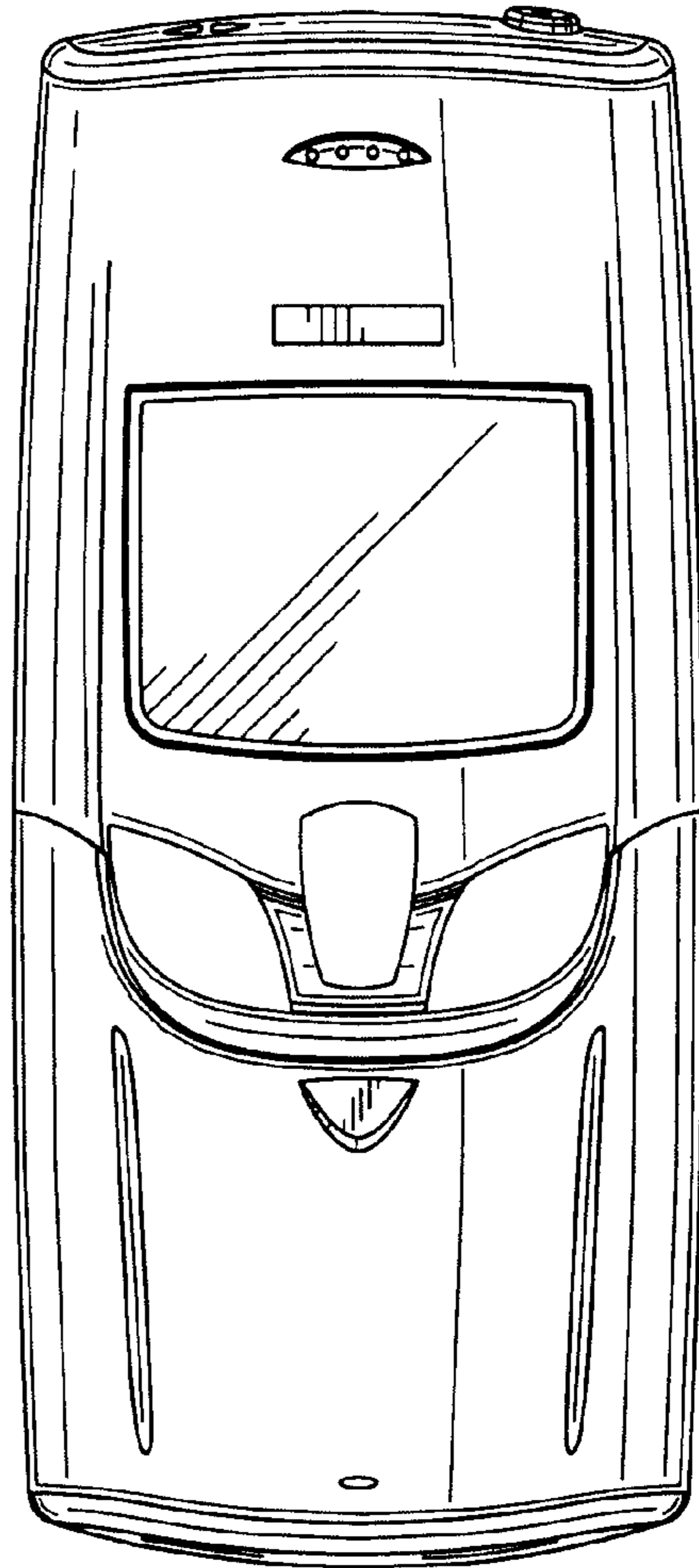

FIG. 3



FIG. 4



FIG. 5

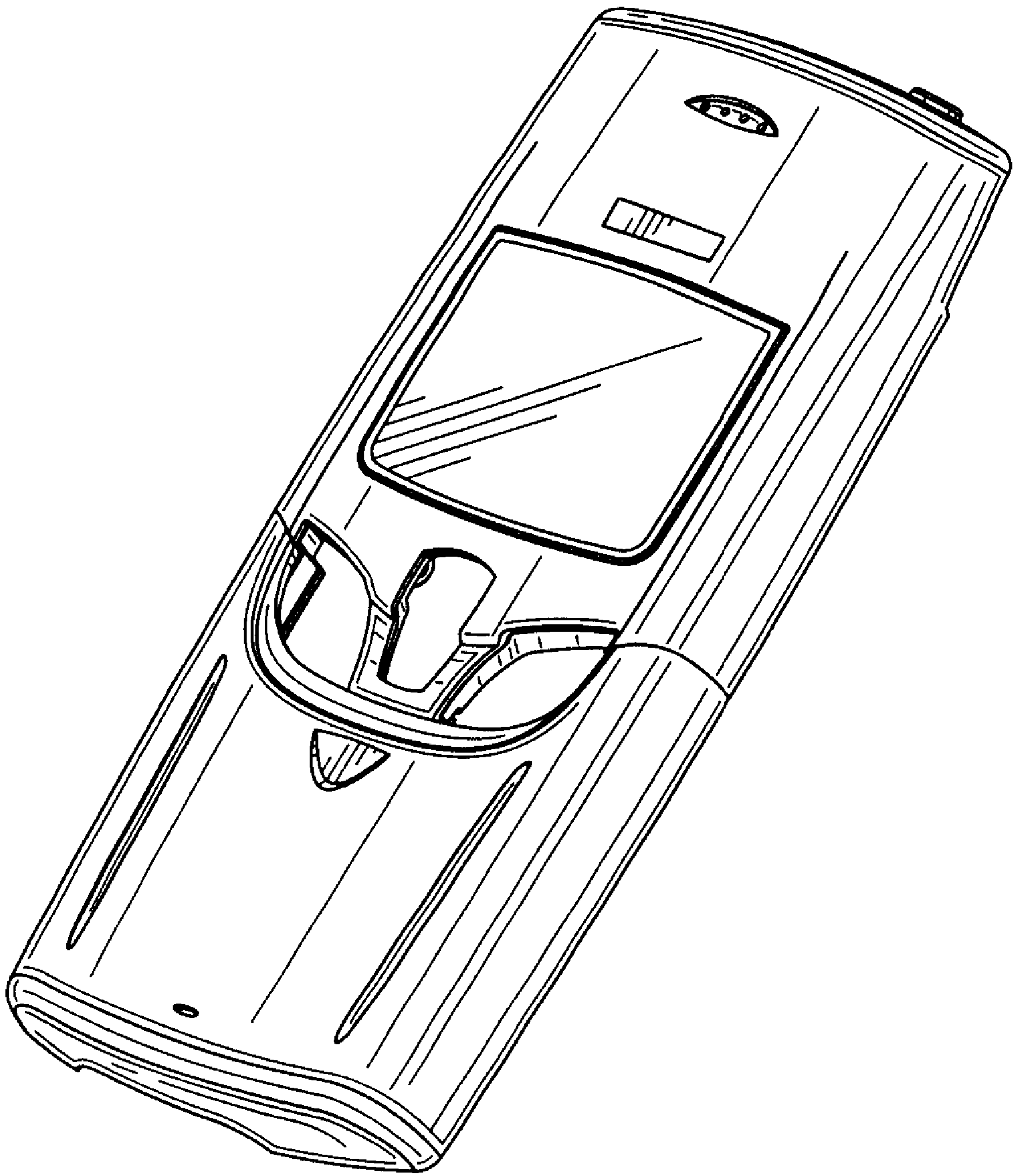

FIG. 6



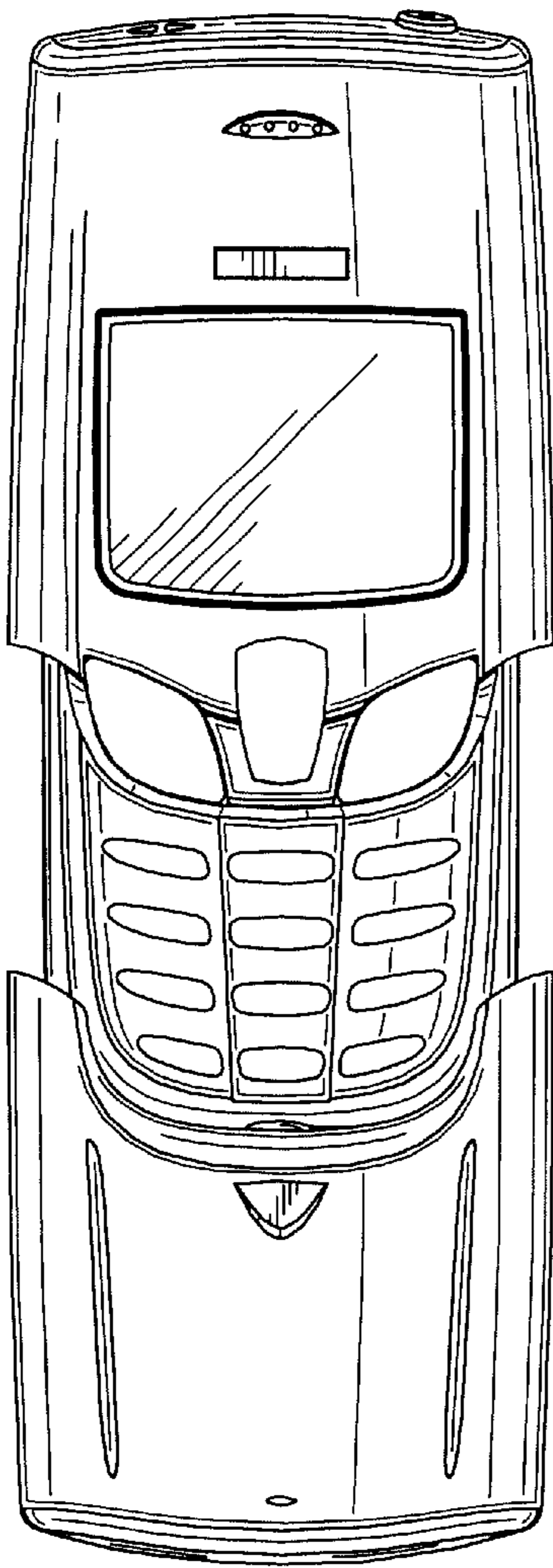

FIG. 7

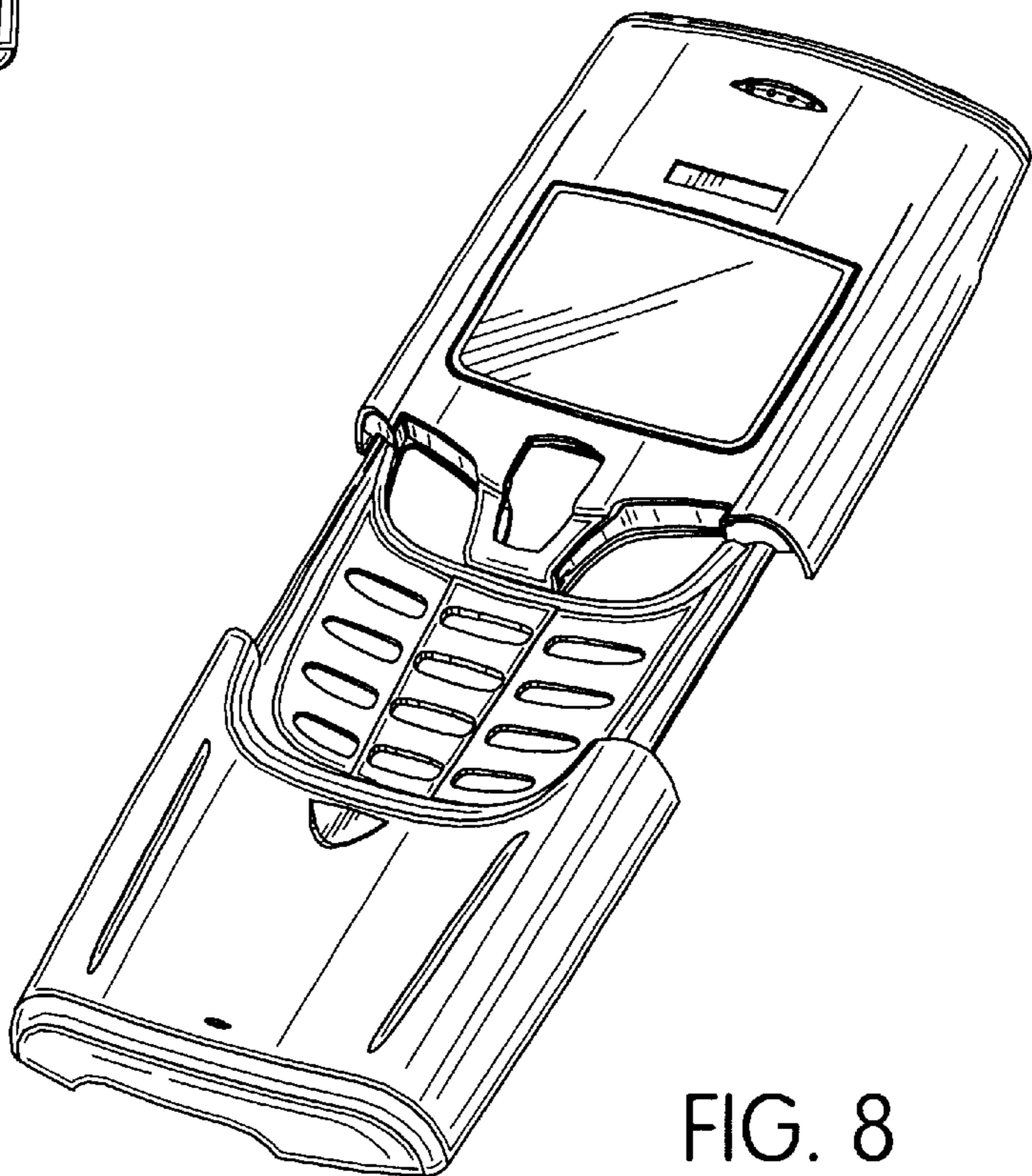

FIG. 8