



US00D475004S

(12) **United States Design Patent**
Chiang

(10) **Patent No.:** **US D475,004 S**

(45) **Date of Patent:** **** May 27, 2003**

(54) **ENGINE HOOD FOR AUTOMOBILES**

D461,434 S * 8/2002 Hoyle, Jr. D12/173

(75) Inventor: **Tommy Chiang**, Taipei (TW)

* cited by examiner

(73) Assignee: **Grand HC Auto Tooling Corp.**, Taipei (TW)

Primary Examiner—Melody N. Brown
(74) *Attorney, Agent, or Firm*—Leong C. Lei

(**) Term: **14 Years**

(57) **CLAIM**

(21) Appl. No.: **29/167,026**

The ornamental design for an engine hood for automobiles, as shown and described.

(22) Filed: **Sep. 9, 2002**

DESCRIPTION

(51) **LOC (7) Cl.** **12-16**

(52) **U.S. Cl.** **D12/173**

(58) **Field of Search** D12/173, 90-92,
D12/86; 180/69.21, 69.2, 69.22, 69.25

FIG. 1 is perspective view of an engine hood for automobiles showing my new design;
FIG. 2 is a front side elevation view thereof;
FIG. 3 is a rear side elevation view thereof;
FIG. 4 is a left side elevation view thereof;
FIG. 5 is a right side elevation view thereof;
FIG. 6 is a top plan view thereof; and,
FIG. 7 is a bottom plan view thereof.

(56) **References Cited**

U.S. PATENT DOCUMENTS

- D391,909 S * 3/1998 Wittine D12/173
- D433,359 S * 11/2000 Hoyle, Jr. D12/173
- D446,175 S * 8/2001 Hoyle, Jr. D12/173

1 Claim, 5 Drawing Sheets

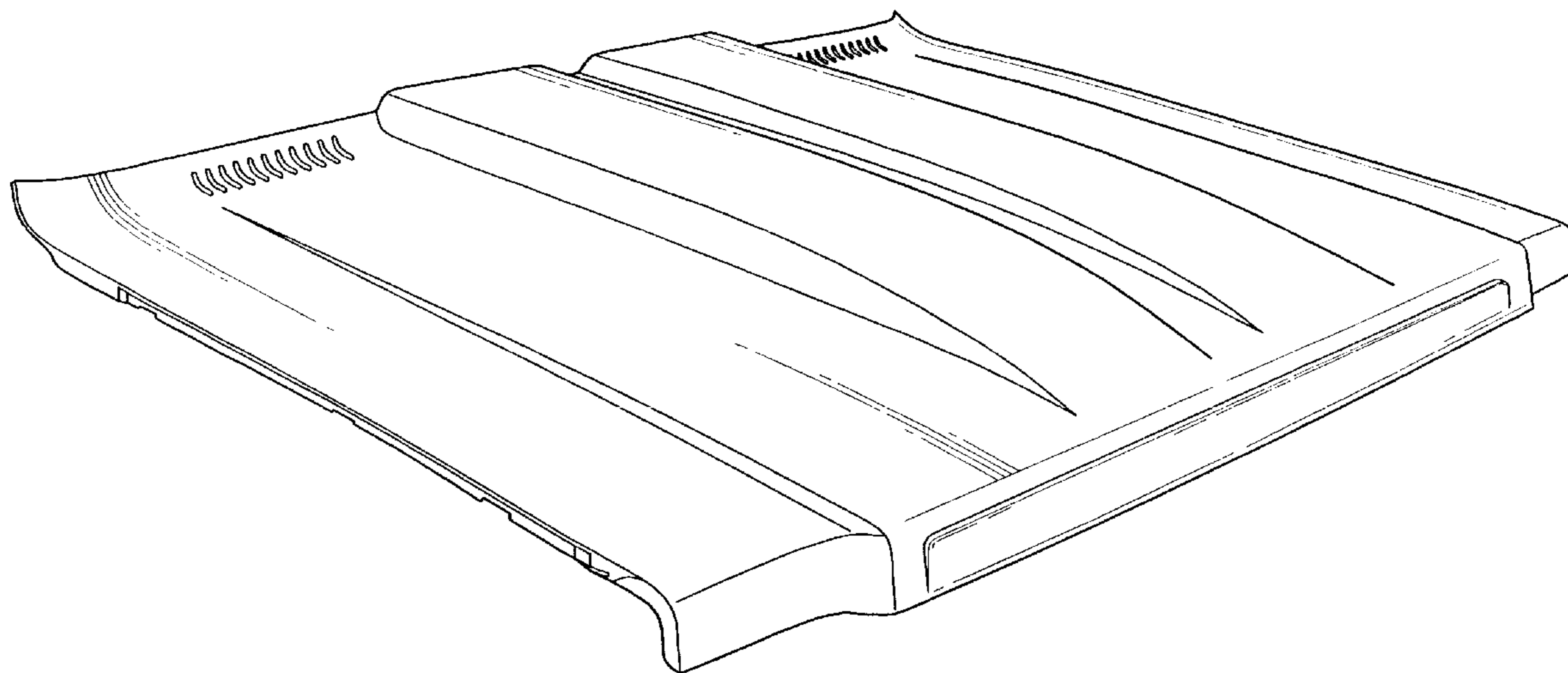

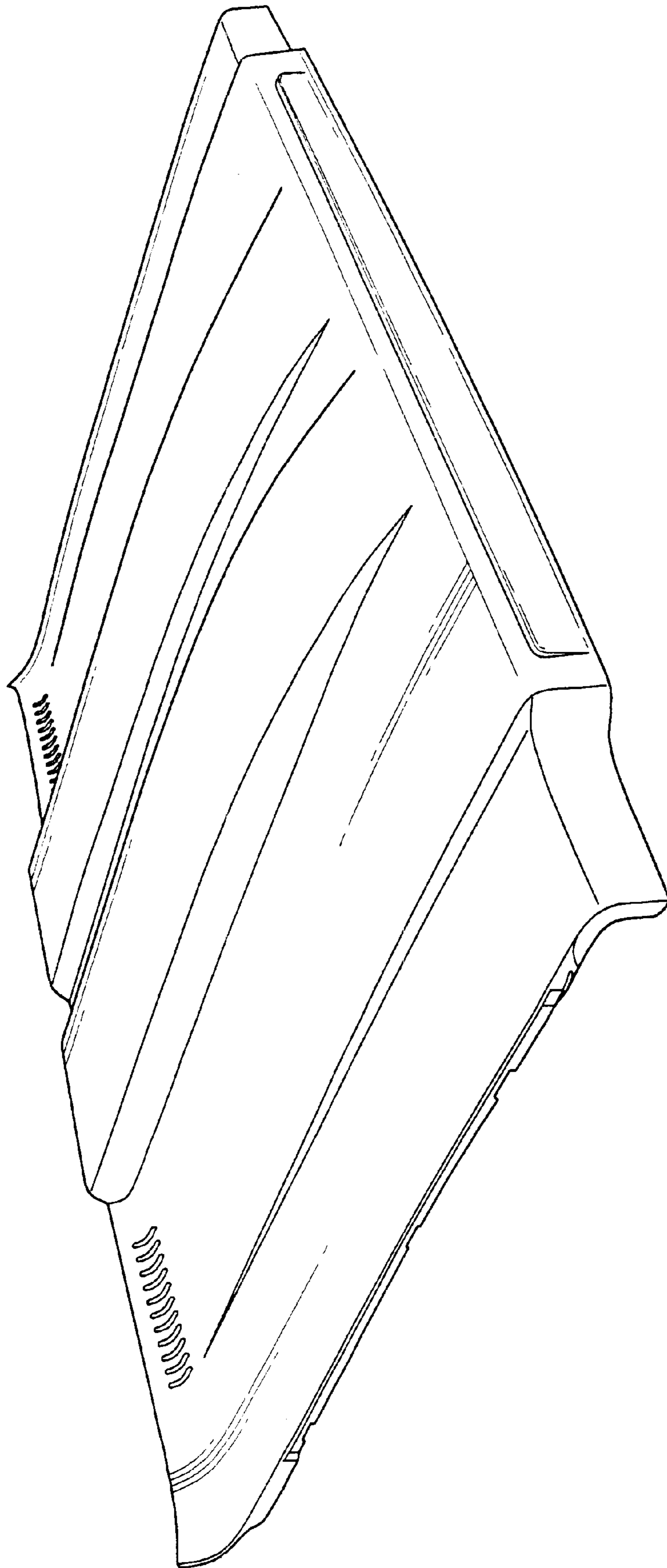

FIG. 1

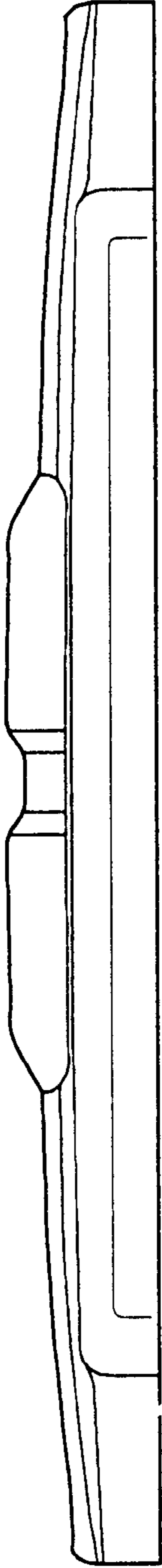

FIG. 2

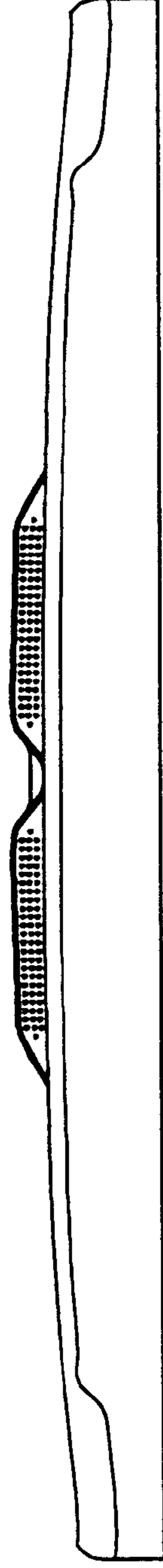

FIG. 3

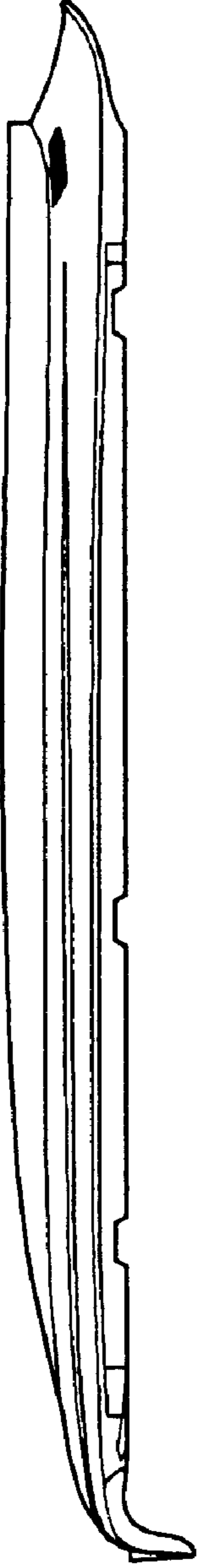

FIG. 4



FIG. 5

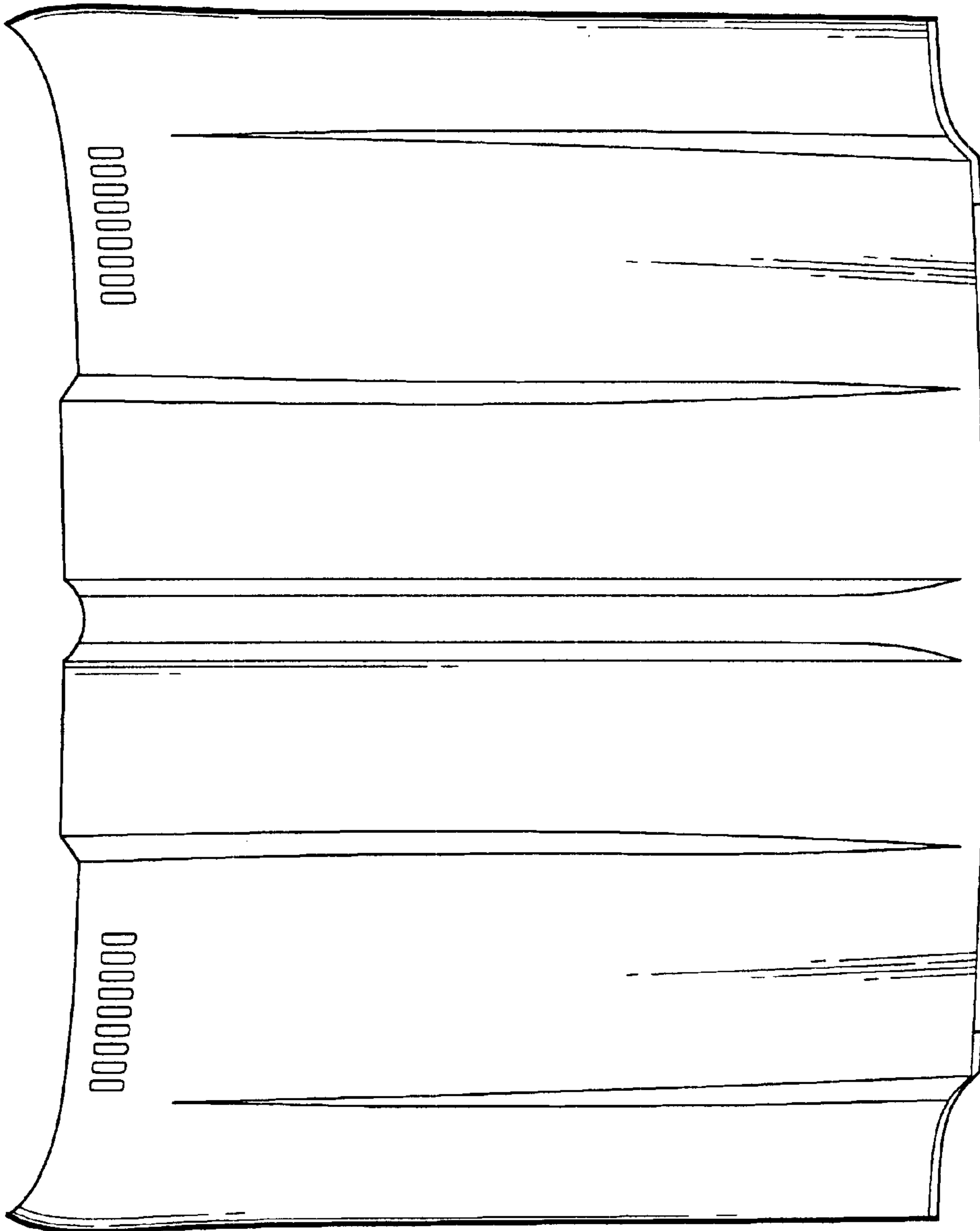

FIG. 6

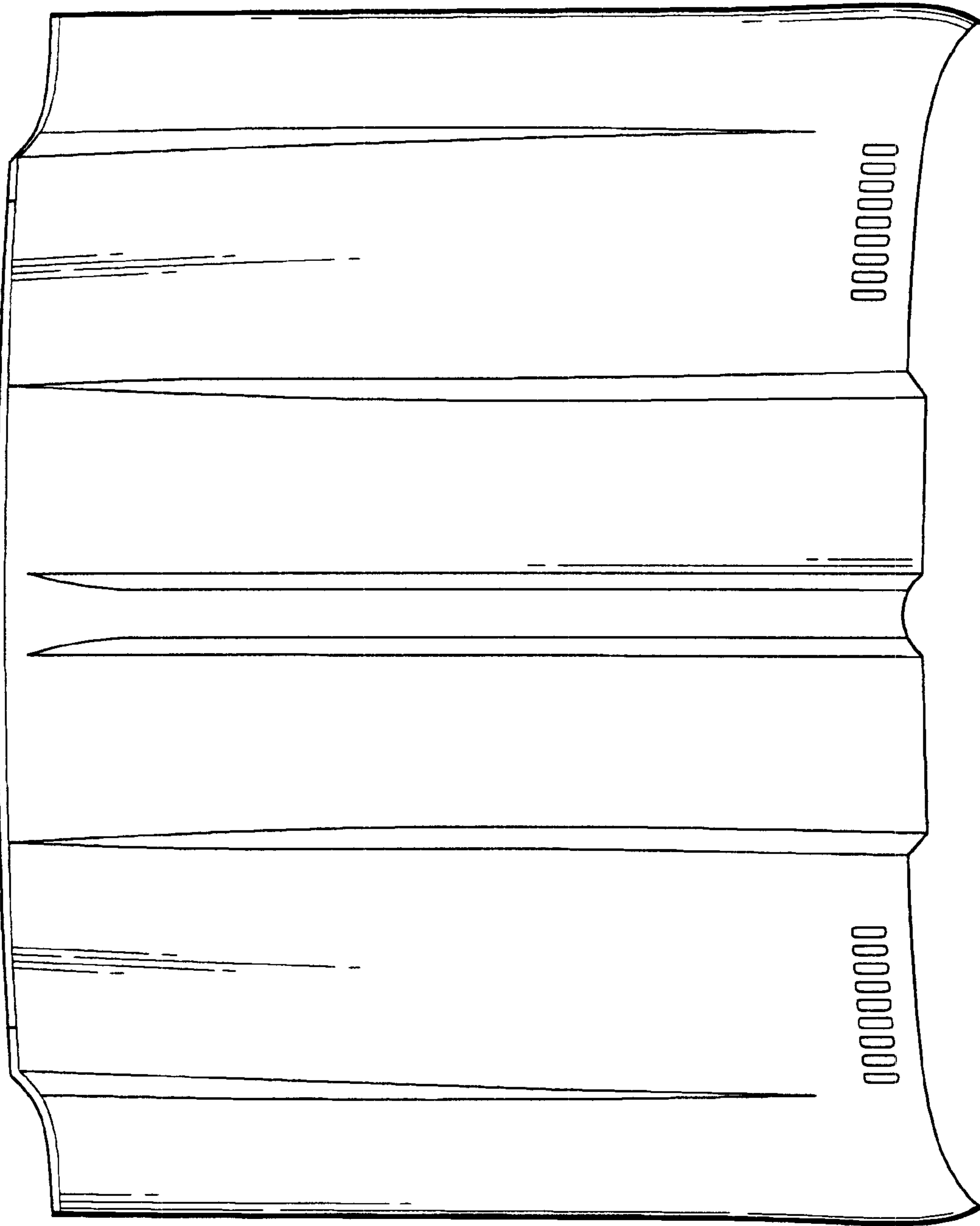

FIG. 7