



US00D474963S

(12) **United States Design Patent** (10) **Patent No.:** **US D474,963 S**
Gersten et al. (45) **Date of Patent:** **** May 27, 2003**

(54) **ANTIPERSPIRANT AND/OR DEODORANT PRODUCT**

FOREIGN PATENT DOCUMENTS

(75) Inventors: **Iris Davis Gersten**, Rockville, MD (US); **Hermes van der Lee**, Rockville, MD (US); **James L. Solan**, Rockville, MD (US)

DE	199 21 183 A1	9/2000
FR	977194	3/1951
GB	2014507 A	2/1979
GB	D2081820	7/1999
WO	WO 99/23998	5/1999
WO	WO 00/19861	4/2000

(73) Assignee: **The Gillette Company**, Boston, MA (US)

OTHER PUBLICATIONS

(**) Term: **14 Years**

The Body Shop Skin & Hair Care Products catalog holiday edition c 1995; p. 16 makeup indicated by arrows. "bac deo-stick", undated. "bac deo-stick" undated.

(21) Appl. No.: **29/154,400**

(22) Filed: **Jan. 23, 2002**

Primary Examiner—Ted Shooman

Assistant Examiner—Daniel Bui

(74) *Attorney, Agent, or Firm*—Fish & Richardson P.C.

Related U.S. Application Data

(63) Continuation of application No. 29/154,400, filed on Jan. 23, 2002.

(57) **CLAIM**

(51) **LOC (7) Cl.** **09-01**

The ornamental design for an antiperspirant and/or deodorant product, as shown and described.

(52) **U.S. Cl.** **D9/338**

(58) **Field of Search** D9/338-339, 500, D9/502-503, 530, 537-538, 540, 543, 548-550, 563, 573-575, 499; 206/37-38, 204, 438, 459.5, 527; 215/200, 205, 231, 260, 270-271, 316, 329, 400; 220/200, 288, 289, 290, 890; 221/208, 209, 293; 222/173, 175, 465.1, 544, 548

DESCRIPTION

(56) **References Cited**

U.S. PATENT DOCUMENTS

D27,864 S	11/1897	Blackman	
692,481 A	2/1902	Robinson	
964,422 A	7/1910	Hood	
1,669,016 A	5/1928	O'Neil	
1,791,359 A	2/1931	Henriksen	
2,101,540 A	12/1937	Gullich	
2,165,420 A	7/1939	Siefert	
2,174,779 A	10/1939	Delorme	
2,613,185 A	10/1952	Marshall	
2,970,083 A	1/1961	Bell	
D201,229 S *	5/1965	Burke D73/1
3,294,692 A	12/1966	Kelly et al.	

FIG. 1 is a perspective view of an antiperspirant and/or deodorant product showing the new design; FIG. 2 is a top plan view of the antiperspirant and/or deodorant product of FIG. 1; FIG. 3 is a front elevation view of the antiperspirant and/or deodorant product of FIG. 1, the rear elevation view being a mirror image thereof; FIG. 4 is a side elevation view of the antiperspirant and/or deodorant product of FIG. 1, the other side elevation view being a mirror image thereof; and, FIG. 5 is a bottom plan view of the antiperspirant and/or deodorant product of FIG. 1.

The broken lines showing the bottom portion of the container beneath the broken line boundary are for illustrative purposes only and form no part of the claimed design.

The stippling represents a surface having a color that contrasts with the color of the surface that does not include stippling. The stippled surface and contrasting surface can be seen through the cap.

(List continued on next page.)

1 Claim, 3 Drawing Sheets

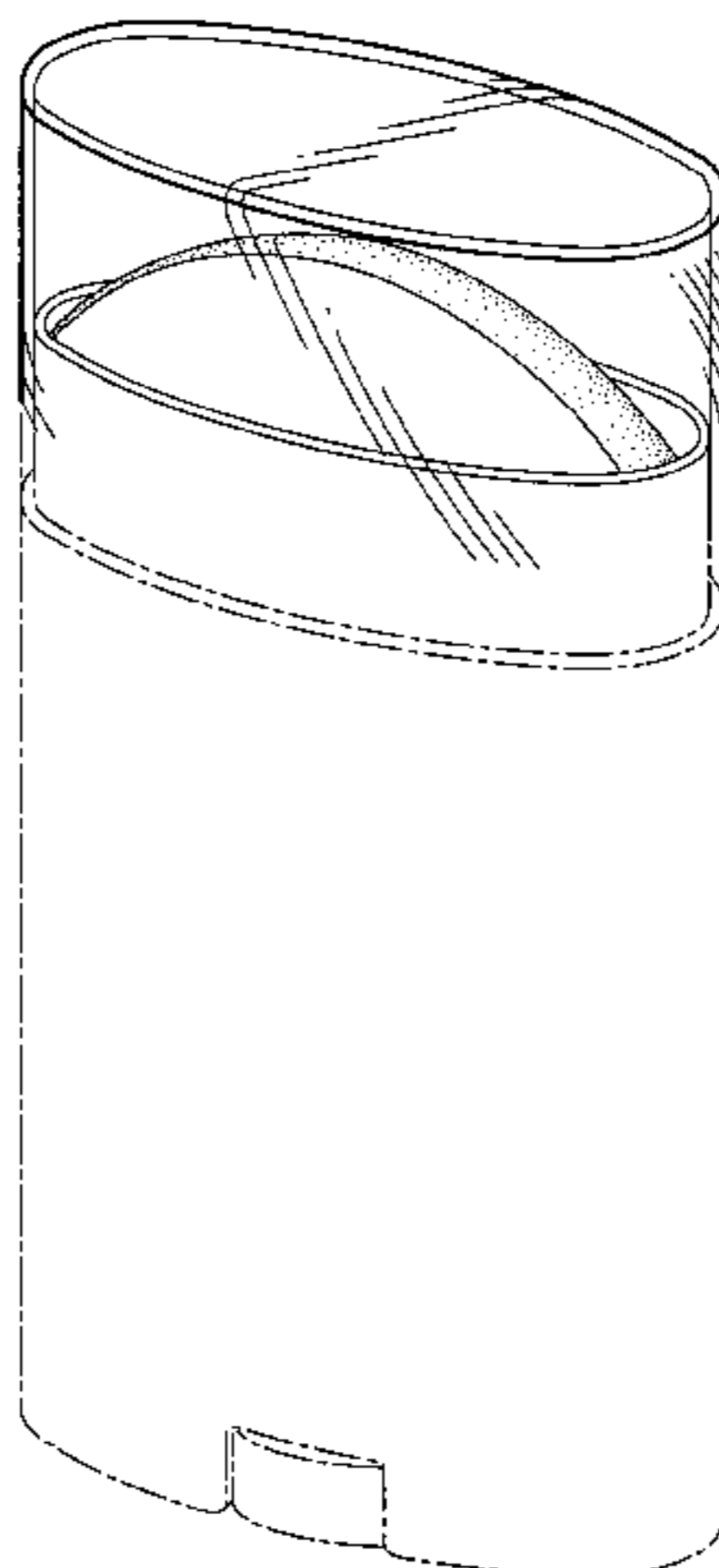

US D474,963 S

Page 2

U.S. PATENT DOCUMENTS							
3,479,429	A	11/1969	Morshauser et al.	D427,059	S * 6/2000	Gebb D9/338	
4,120,948	A	10/1978	Shelton	D430,346	S	8/2000	van der Hagen
4,202,879	A	5/1980	Shelton	6,096,296	A	8/2000	Alflen et al.
4,393,643	A	7/1983	Fryar et al.	D443,951	S	6/2001	Look
4,511,552	A	4/1985	Cox	D444,264	S	6/2001	Look
4,524,062	A	6/1985	Laba et al.	D444,265	S	6/2001	Look
4,578,207	A	3/1986	Holdt et al.	D444,593	S	7/2001	Look
D292,775	S	* 11/1987	Keeler et al. D9/338	D444,913	S	7/2001	Look
4,714,085	A	12/1987	Von Kleinsorgen	D446,356	S	8/2001	Look
4,743,443	A	5/1988	Pisani et al.	D446,606	S	8/2001	Look
4,786,449	A	11/1988	Smit	D446,607	S	8/2001	Look
4,879,063	A	11/1989	Wood-Rethwill et al.	D454,227	S	3/2002	Look
D331,534	S	* 12/1992	Thompson et al. D9/338	D454,228	S	3/2002	Look
D333,977	S	* 3/1993	Gatrost et al. D9/337	D454,229	S	3/2002	Look
5,217,639	A	6/1993	Mottola	D454,414	S	3/2002	Look
D344,154	S	2/1994	Mottola	D454,661	S	3/2002	Look
5,330,751	A	7/1994	Curtin et al.	D454,662	S	3/2002	Look
5,417,964	A	5/1995	Carlson, Sr. et al.	D454,663	S	3/2002	Look
5,538,161	A	7/1996	Koehler et al.	D454,664	S	3/2002	Look
5,587,153	A	12/1996	Angelone, Jr. et al.	D454,665	S	3/2002	Look
5,705,171	A	1/1998	Iovanni et al.	D454,666	S	3/2002	Look
5,759,974	A	6/1998	Menke et al.	D454,983	S	3/2002	Look
D414,689	S	* 10/1999	Ruello D9/338	D454,984	S	3/2002	Look
5,965,501	A	10/1999	Rattinger et al.	D454,985	S	3/2002	Look
D423,713	S	4/2000	Szekely				

* cited by examiner

FIG. 1

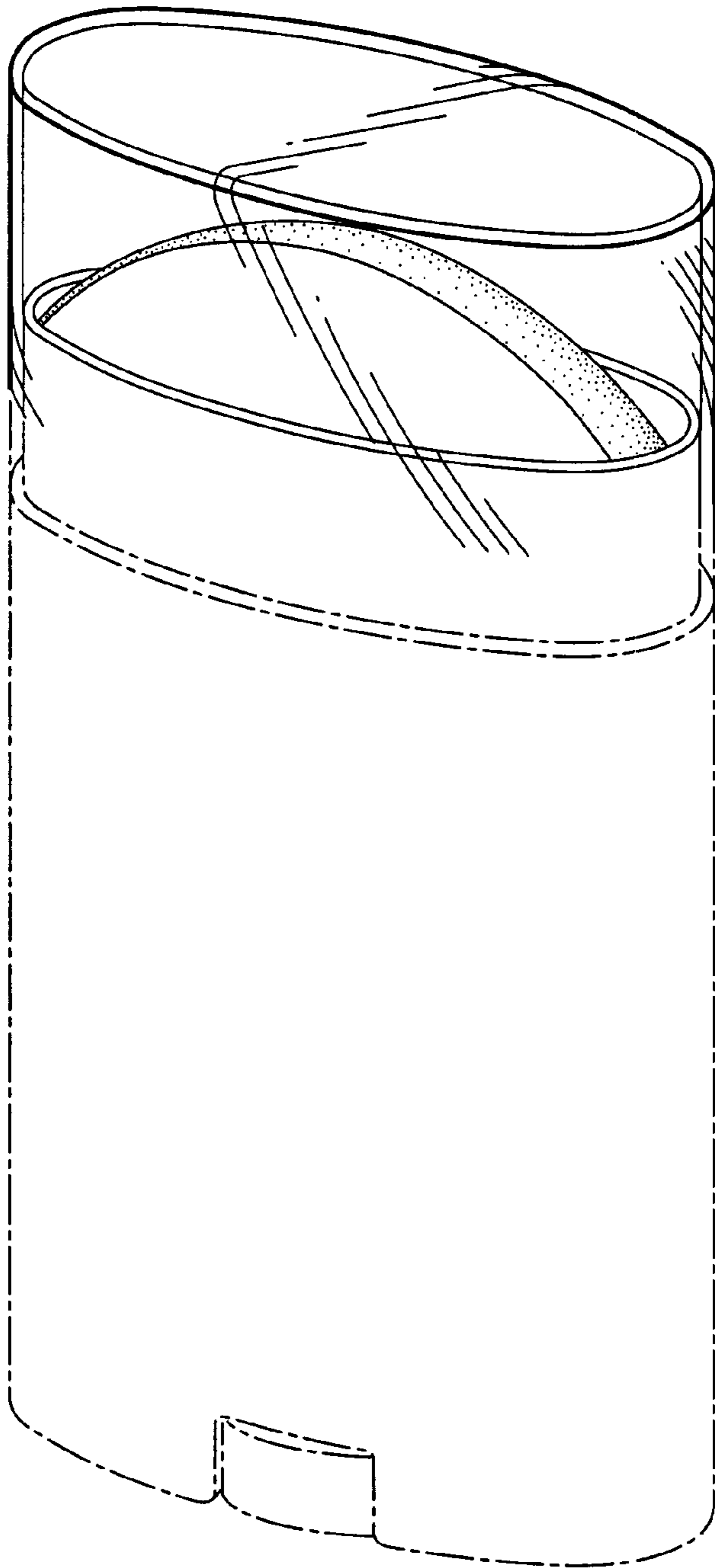

FIG. 2

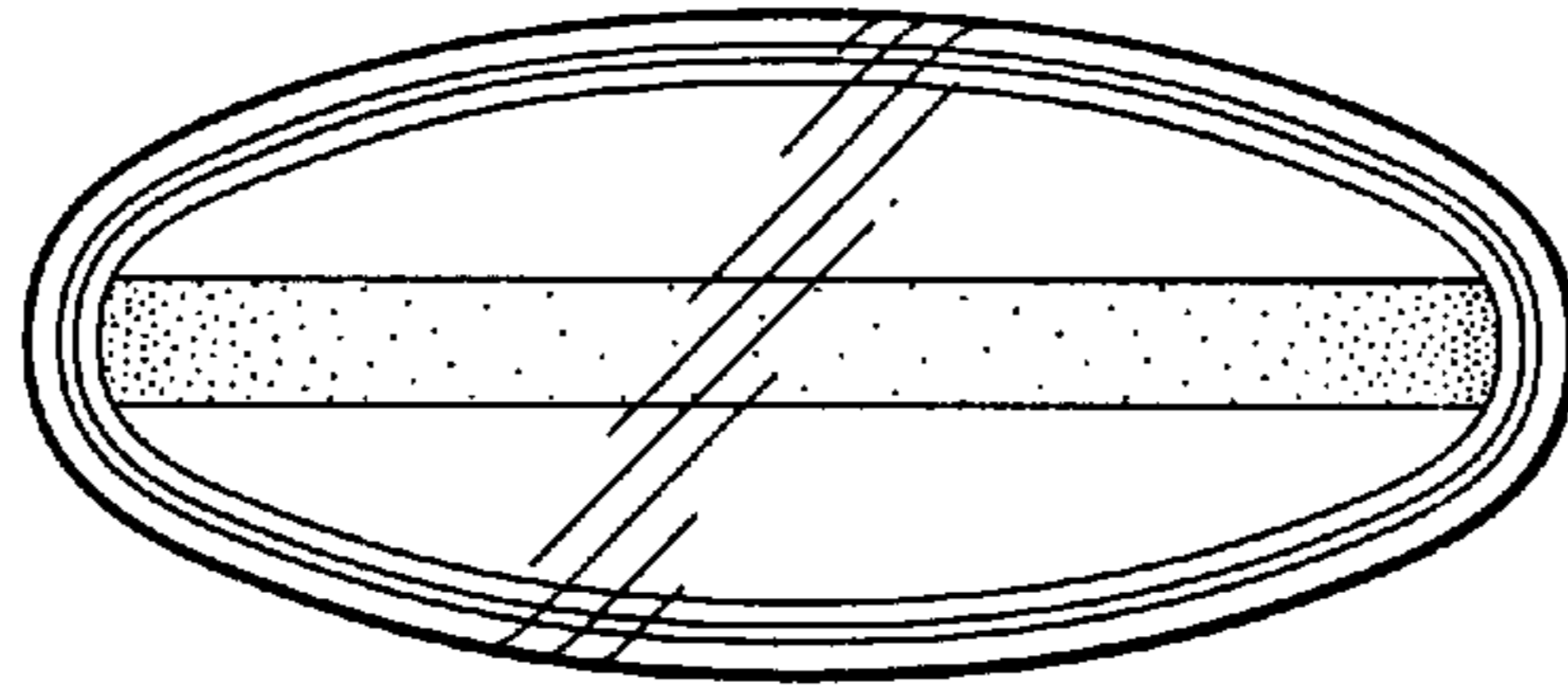

FIG. 3

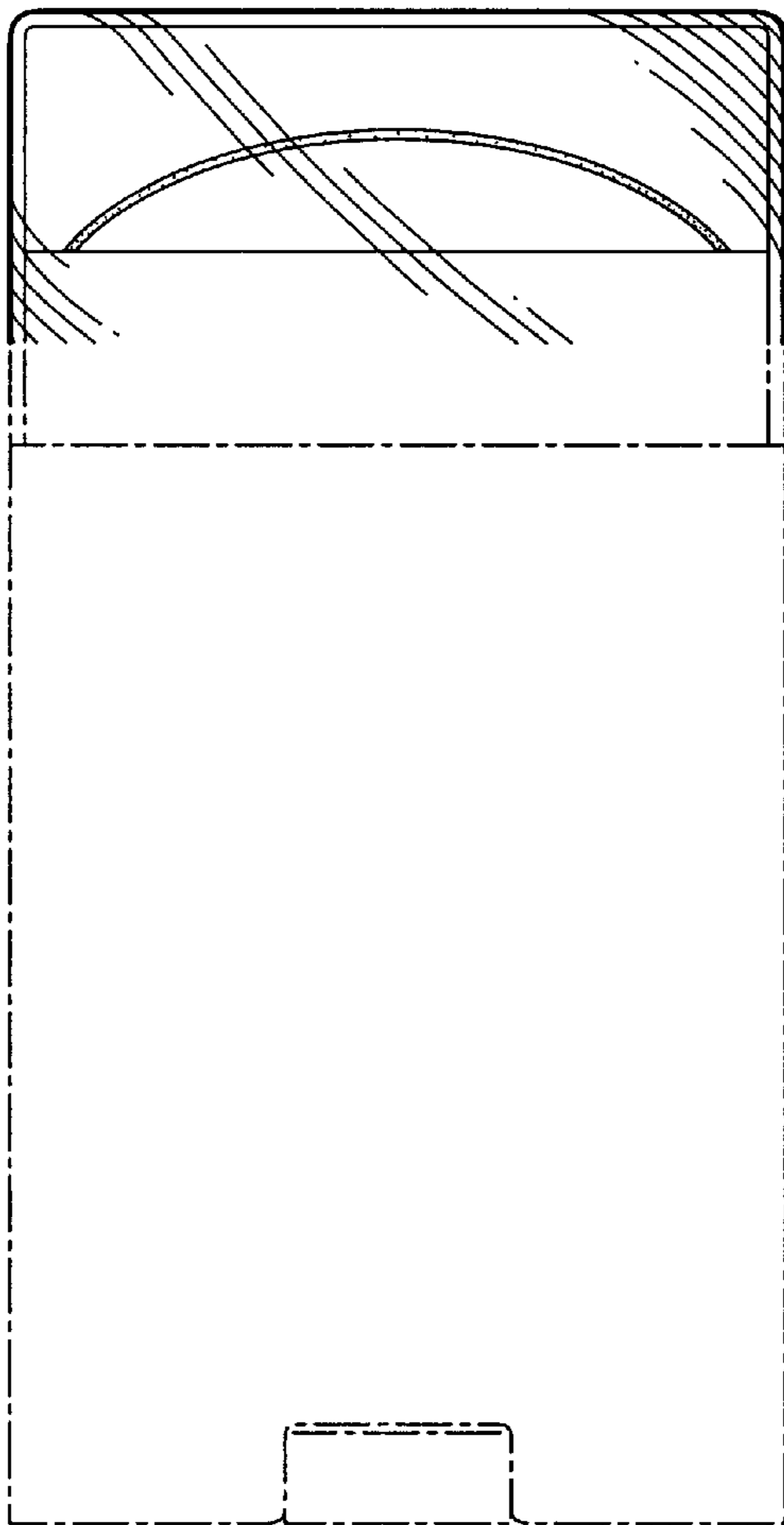

FIG. 4

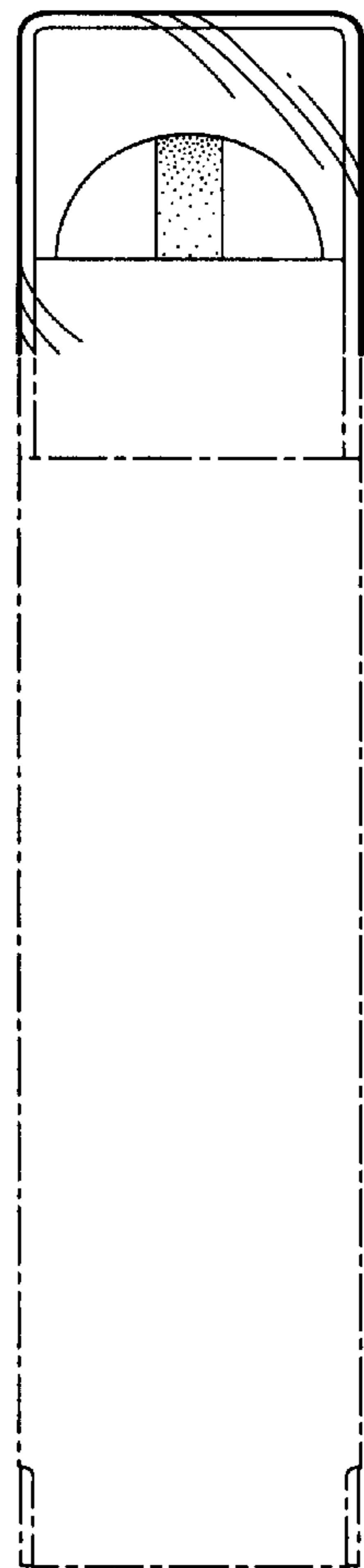
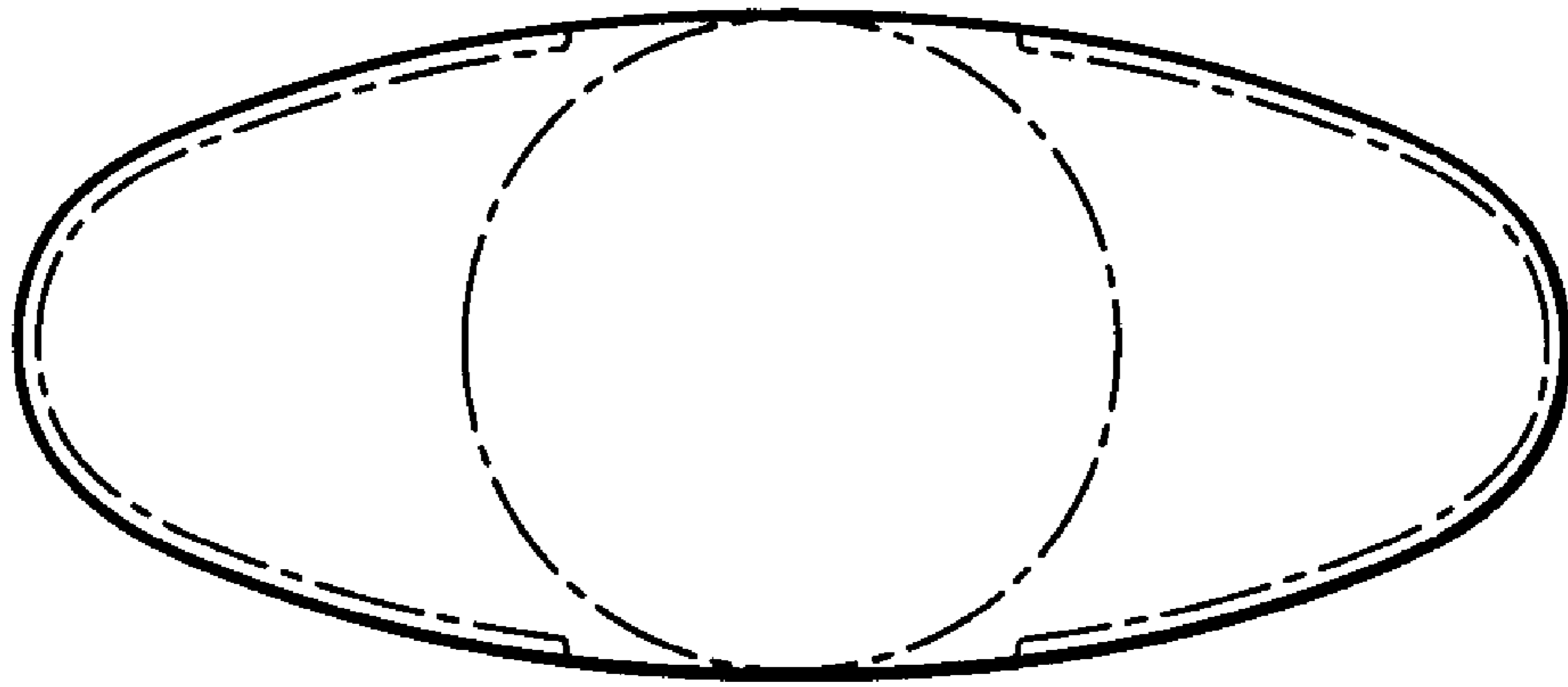

FIG. 5



UNITED STATES PATENT AND TRADEMARK OFFICE
CERTIFICATE OF CORRECTION

PATENT NO. : Des. 474,963 S
DATED : May 27, 2003
INVENTOR(S) : Iris Davis Gersten, Hermes van der Lee and James L. Solan

Page 1 of 1

It is certified that error appears in the above-identified patent and that said Letters Patent is hereby corrected as shown below:

Title page,

Item [56], **References Cited**, U.S. PATENT DOCUMENTS, insert

-- US 2002/0041788 A1, 04/2002 Look et al., --.

FOREIGN PATENT DOCUMENTS, insert -- WO 01/91605 12/06/01 --; and replace "9/2000" with -- 11/2000 --.

Item [57], **ABSTRACT**, insert -- Be it known that Iris Davis Gersten, Hermes van der Lee and James Solan have invented a certain new, original and ornamental design for an antiperspirant and/or deodorant product, of which the following is a specification, reference being had to the following drawings, forming a part hereof. --

Signed and Sealed this

Thirteenth Day of April, 2004

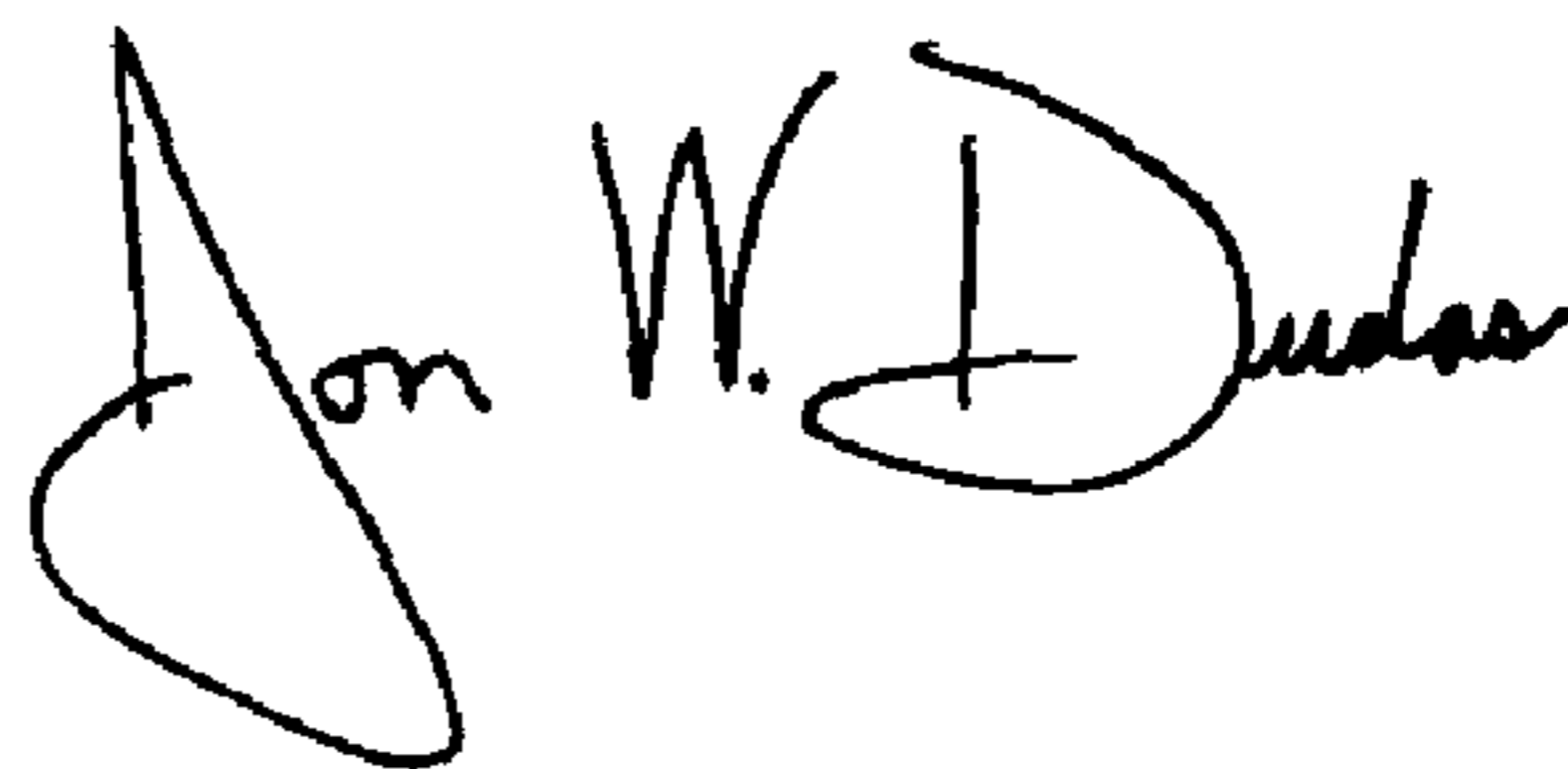

JON W. DUDAS

Acting Director of the United States Patent and Trademark Office