



US00D474936S

(12) **United States Design Patent**  
**Groll**

(10) **Patent No.:** **US D474,936 S**

(45) **Date of Patent:** **\*\* May 27, 2003**

(54) **COOKING VESSEL**

(75) Inventor: **William A. Groll**, McMurray, PA (US)

(73) Assignee: **Clad Metals LLC**, Canonsburg, PA (US)

(\*\*) Term: **14 Years**

(21) Appl. No.: **29/145,657**

(22) Filed: **Jul. 26, 2001**

**Related U.S. Application Data**

(63) Continuation of application No. 29/116,068, filed on Dec. 23, 1999, now Pat. No. Des. 449,204.

(51) **LOC (7) Cl.** ..... **07-02**

(52) **U.S. Cl.** ..... **D7/354**

(58) **Field of Search** ..... D7/323, 354-361;  
220/573.1-573.5

(56) **References Cited**

**U.S. PATENT DOCUMENTS**

D118,230 S	12/1939	Fader	.....	D11/156
D248,363 S	7/1978	Rinaldi		
D263,193 S	* 3/1982	Sano	.....	D7/360
D288,648 S	3/1987	Monaghan		
D294,110 S	2/1988	Kenyon	.....	D7/360
D305,601 S	1/1990	Hewson	.....	D7/368
D321,455 S	11/1991	Duquaine, Jr. et al.	.....	D7/361
D328,997 S	9/1992	Gerlach	.....	D7/361
D335,422 S	5/1993	Mano et al.	.....	D7/360
D359,878 S	7/1995	Chen	.....	D7/354
D382,767 S	* 8/1997	Lien	.....	D7/360
D387,767 S	12/1997	Tajima et al.	.....	D14/222
D416,434 S	11/1999	Pollnow	.....	D7/360
D449,204 S	* 10/2001	Groll	.....	D7/354

\* cited by examiner

*Primary Examiner*—Caron D. Veynar

(74) *Attorney, Agent, or Firm*—Webb Ziesenheim Logsdon Orkin & Hanson, P.C.

(57) **CLAIM**

The ornamental design for a cooking vessel, as shown and described.

**DESCRIPTION**

FIG. 1 is a perspective view of a cooking vessel showing my new design;

FIG. 2 is a side view of the cooking vessel of FIG. 1;

FIG. 3 is a perspective view of the claimed design shown on another cooking vessel;

FIG. 4 is a perspective view of the claimed design shown on another cooking vessel;

FIG. 5 is a perspective view of the claimed design shown on another cooking vessel;

FIG. 6 is a perspective view of the claimed design shown on another cooking vessel;

FIG. 7 is a perspective view of the claimed design shown on another cooking vessel;

FIG. 8 is a perspective view of the claimed design shown on another cooking vessel;

FIG. 9 is a perspective view of the claimed design shown on another cooking vessel;

FIG. 10 is a perspective view of the claimed design shown on another cooking vessel;

FIG. 11 is a perspective view of the claimed design shown on another cooking vessel; and,

FIG. 12 is a perspective view of the claimed design shown on another cooking vessel.

The broken lines shown in FIGS. 1-12 are for illustrative purposes only and form no part of the claimed design.

As shown in the appended drawings, the ornamental design of my invention is directed to an indented golden copper colored band formed around the outer periphery on a lower portion of the vessel. It is understood that the golden copper colored band shown in FIGS. 1-2 extends around the circumference of the vessel. FIGS. 1-12 are not lined to show the color for ease for illustration.

**1 Claim, 5 Drawing Sheets**

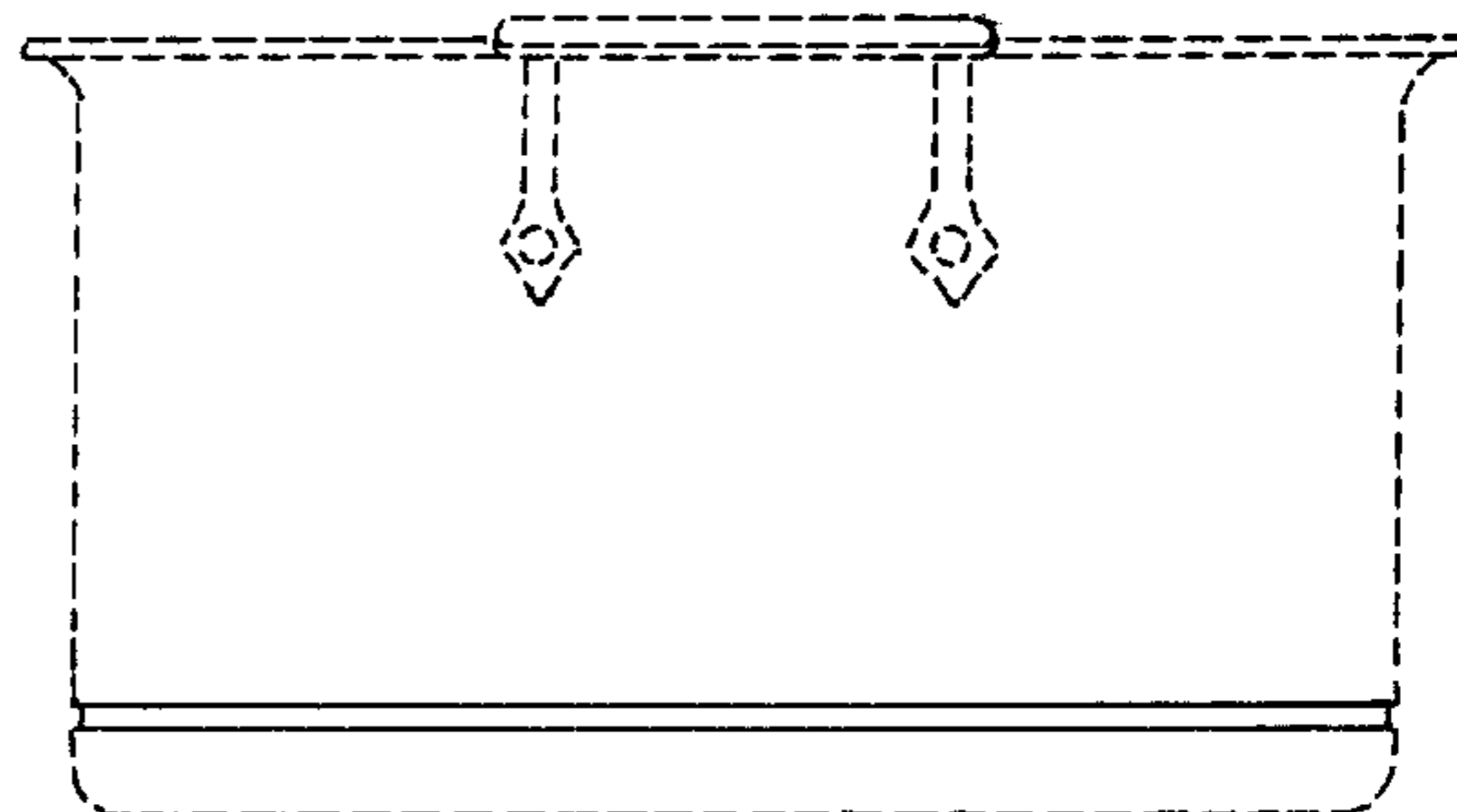
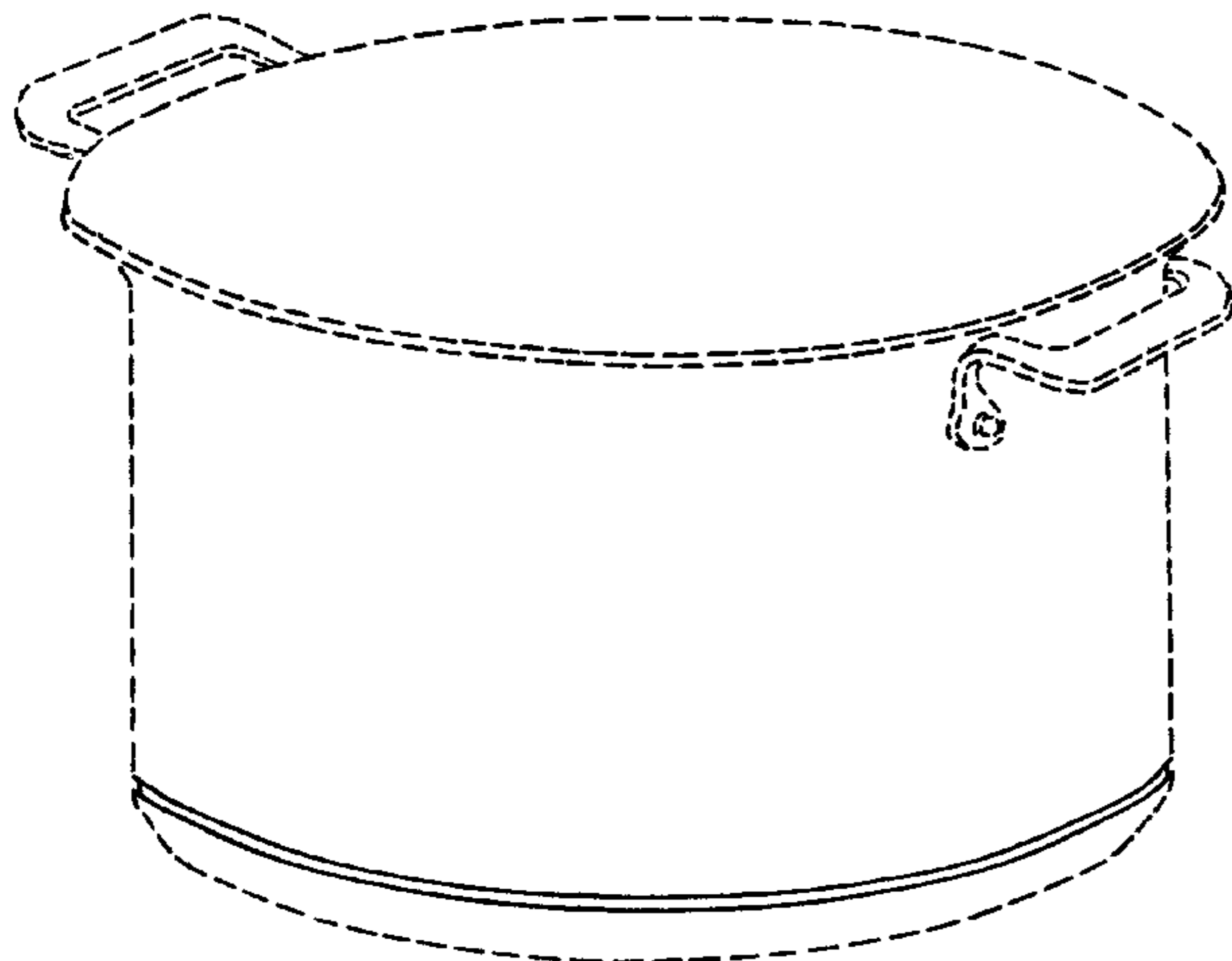

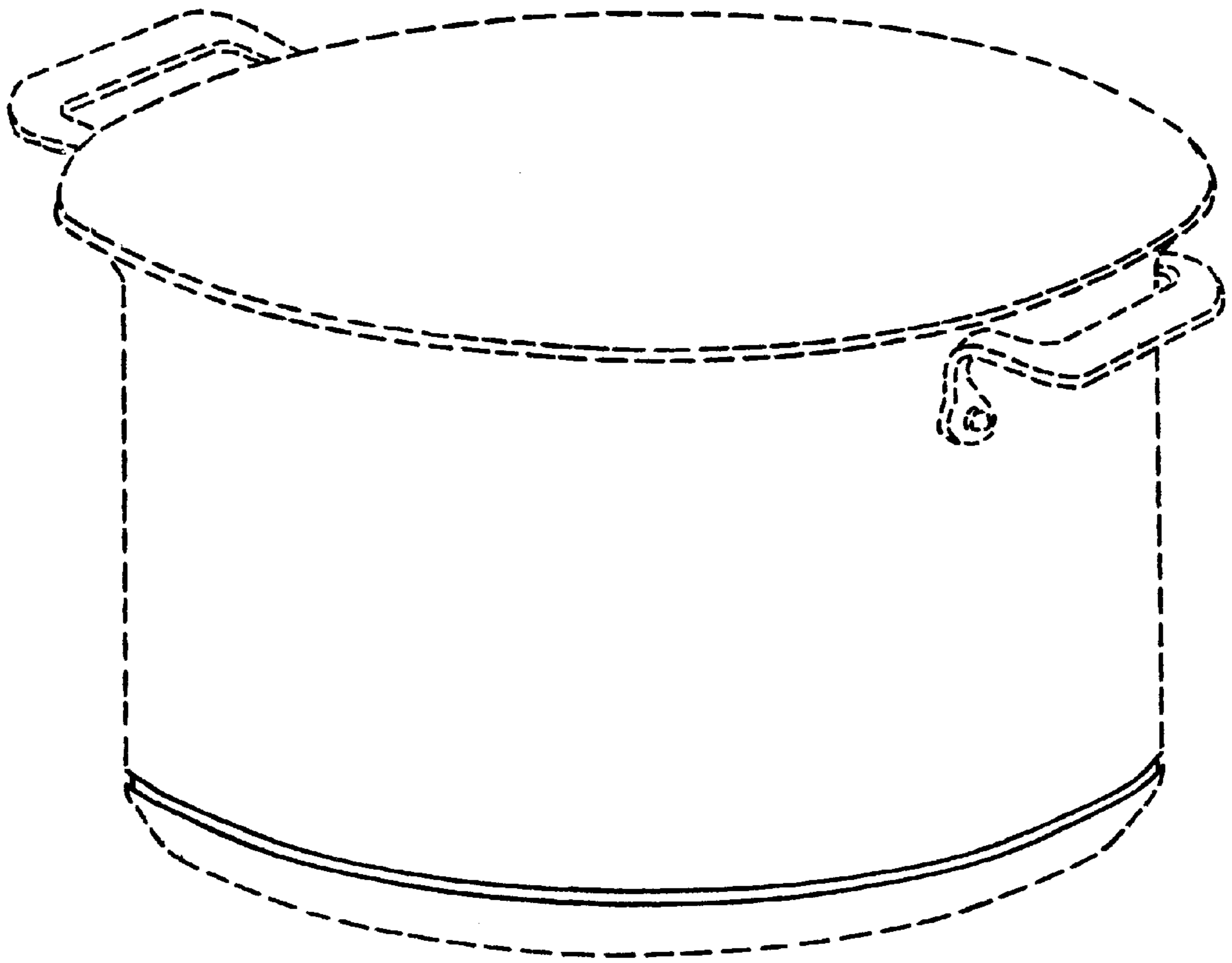

Fig. 1

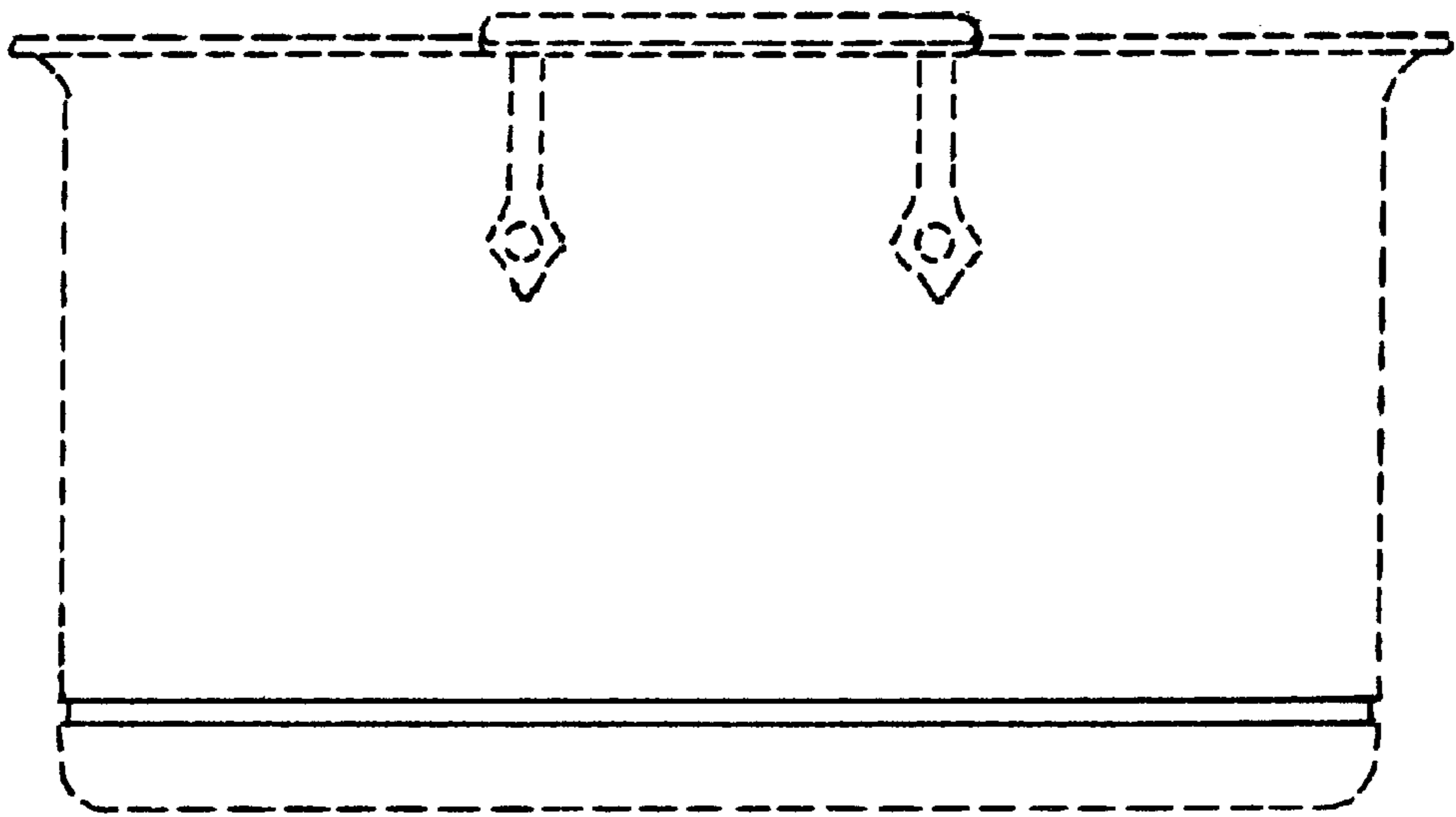

Fig. 2

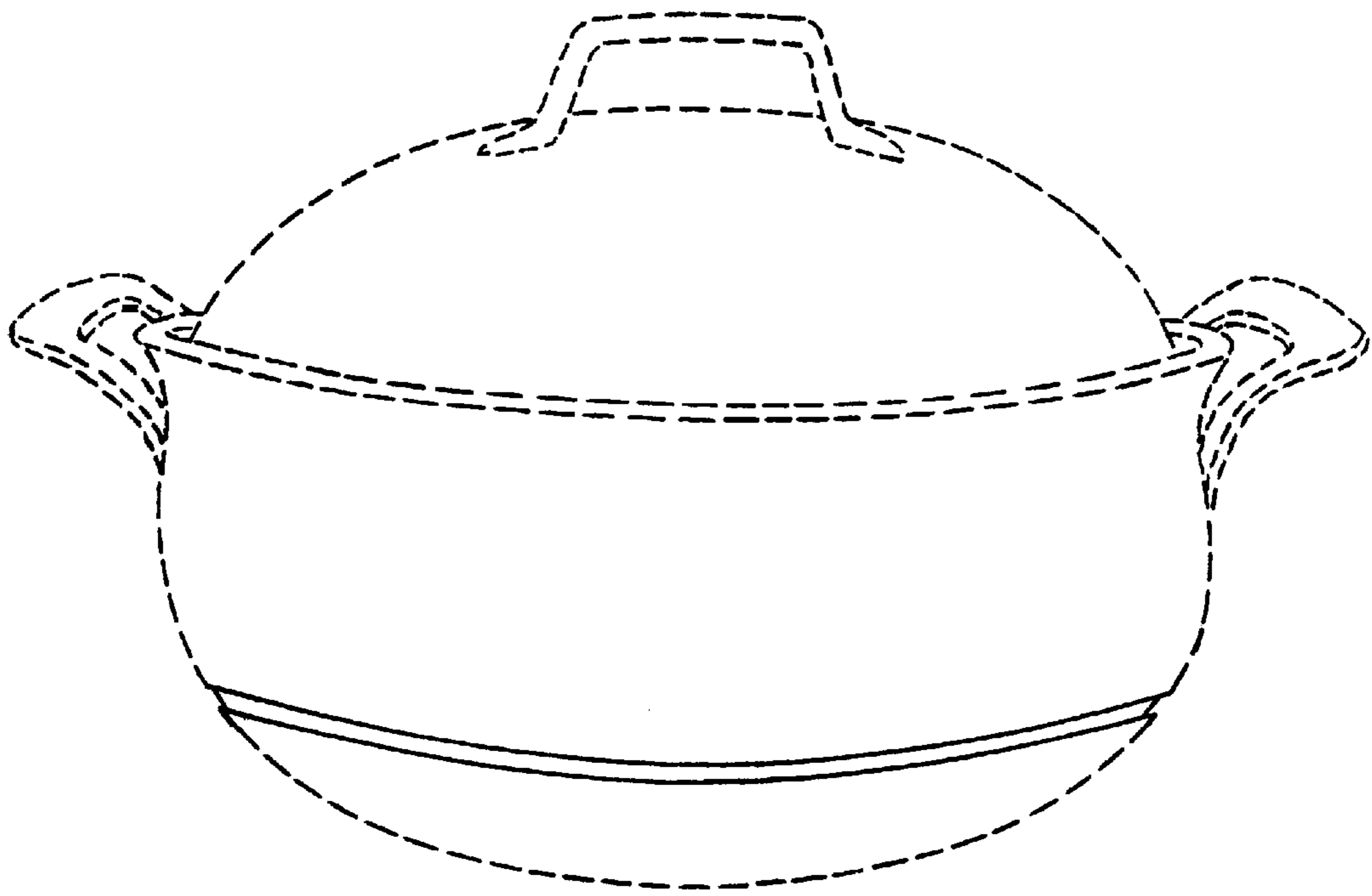

Fig. 3

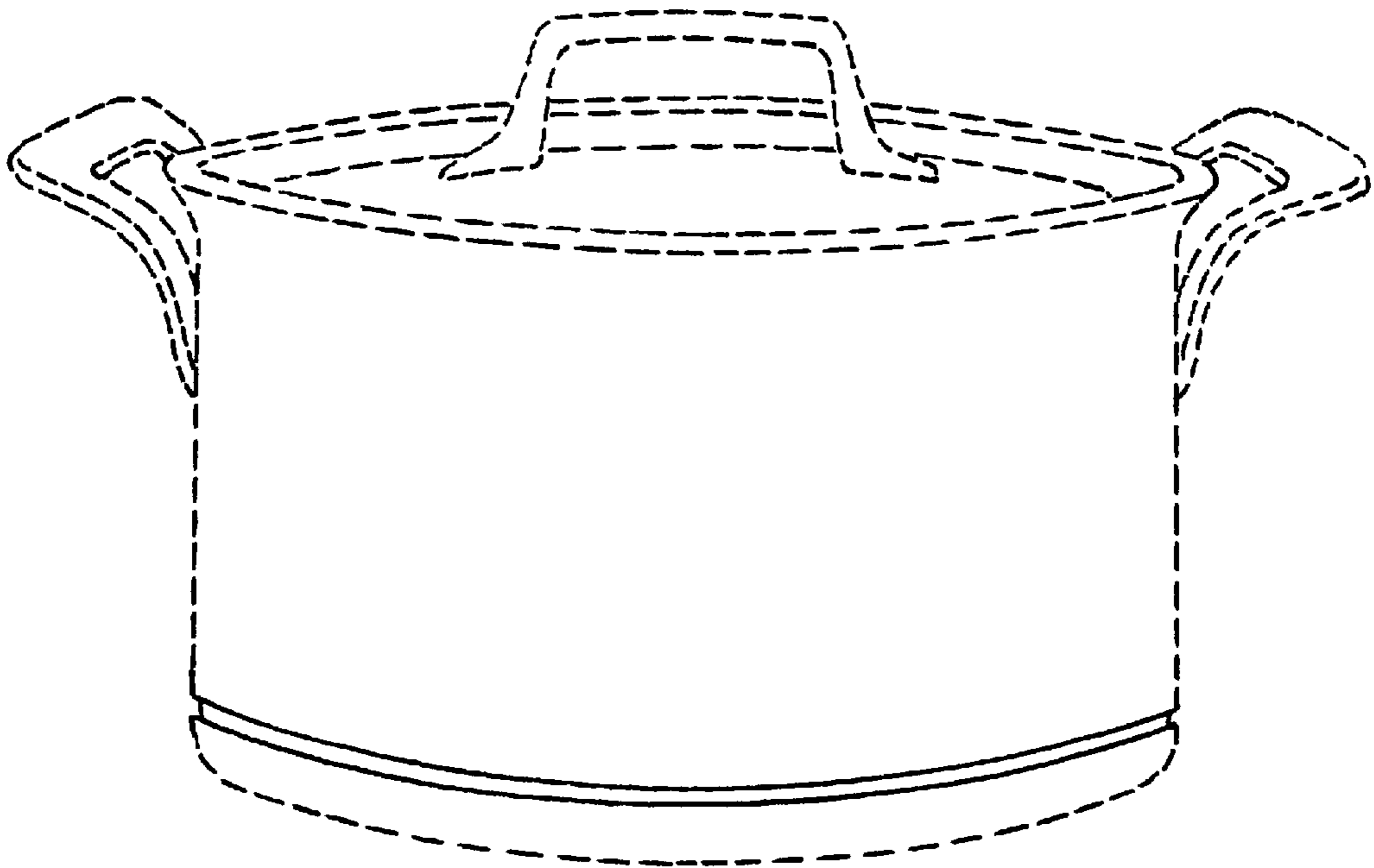

Fig. 4

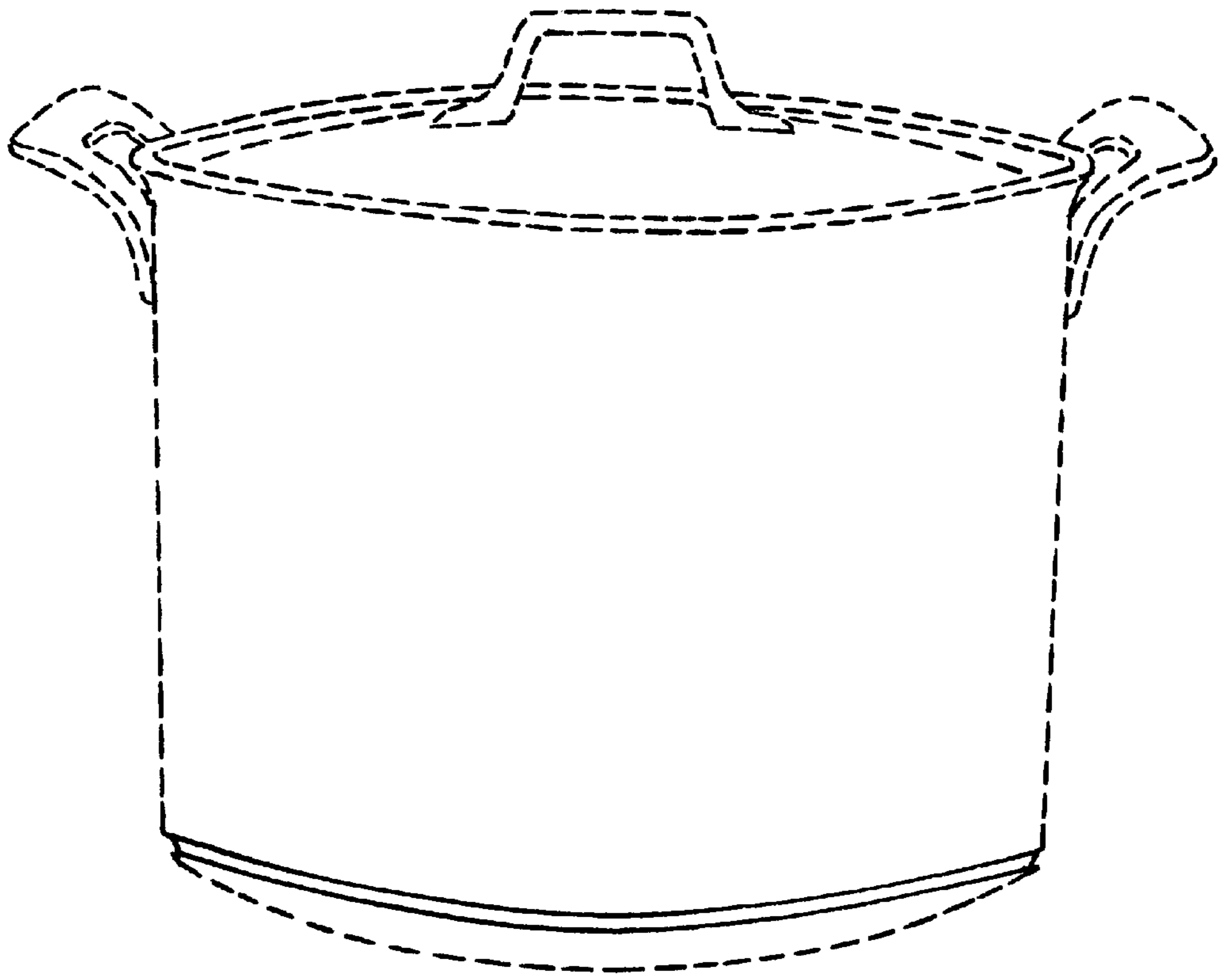

Fig. 5

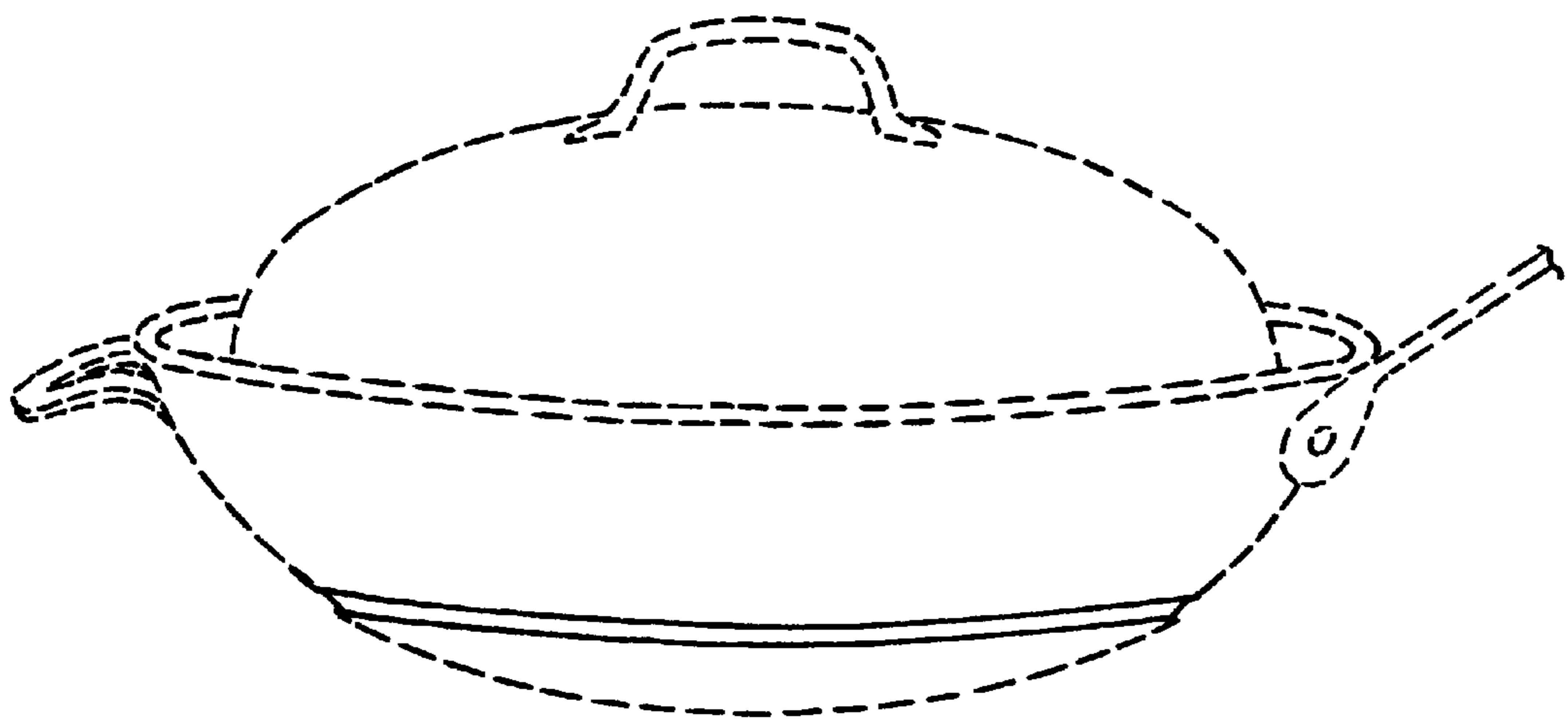

Fig. 6

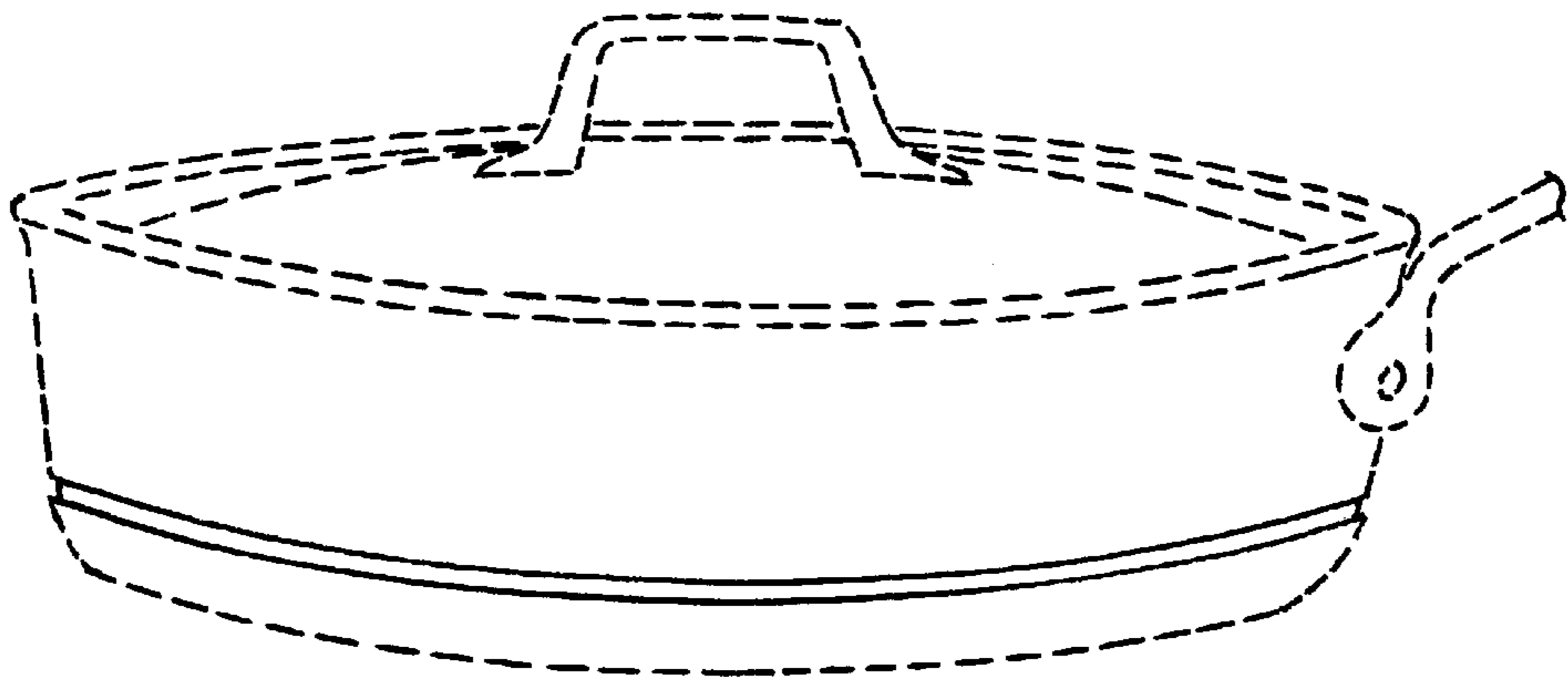

Fig. 7

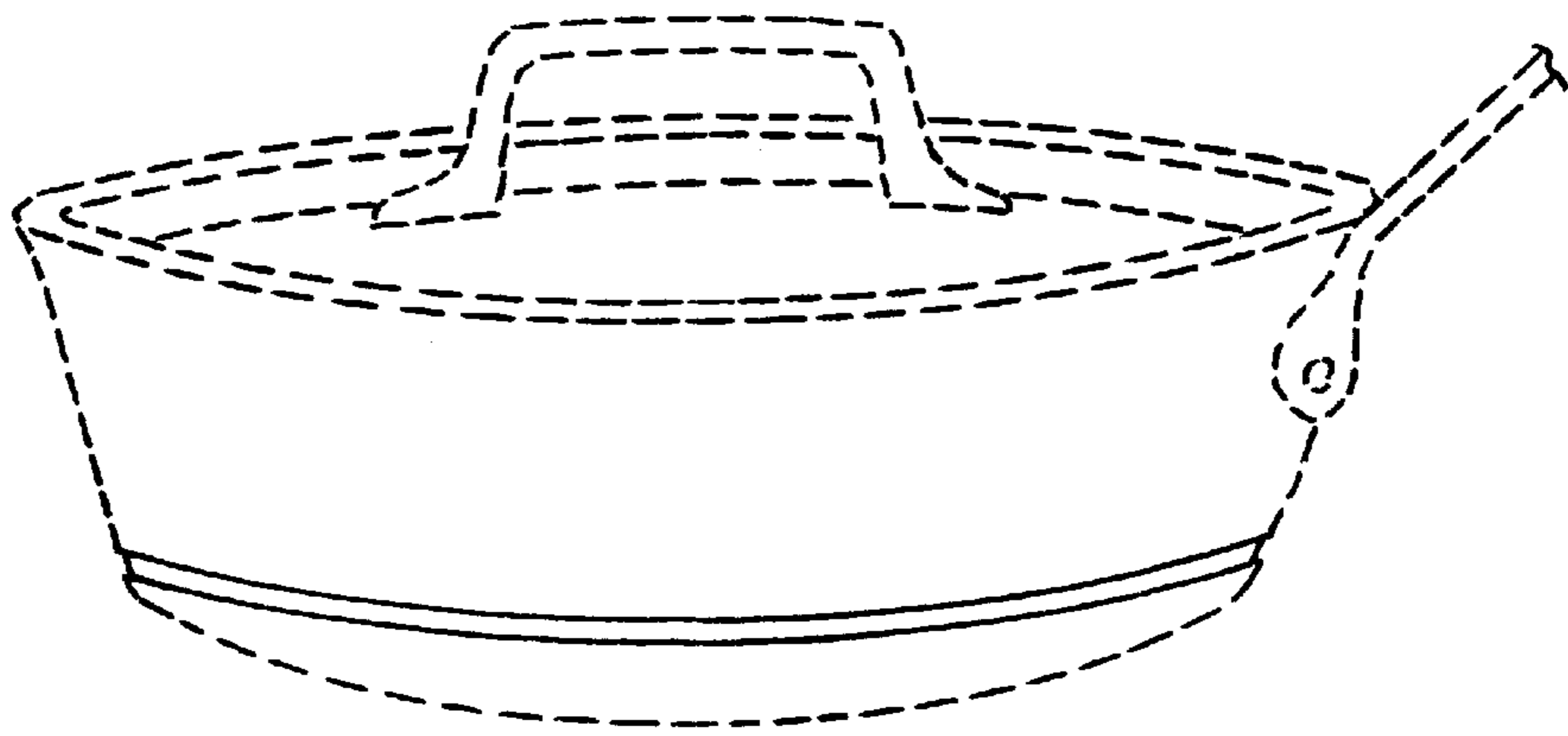

Fig. 8

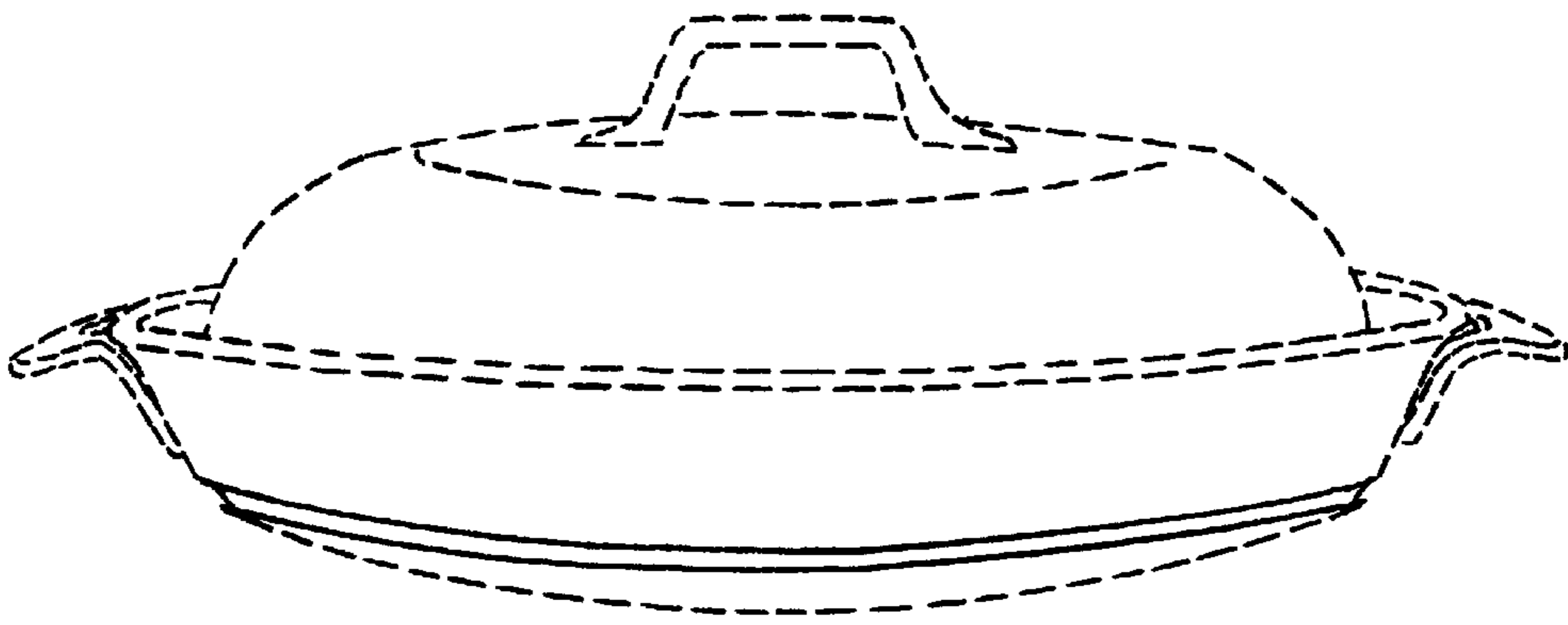

Fig. 9

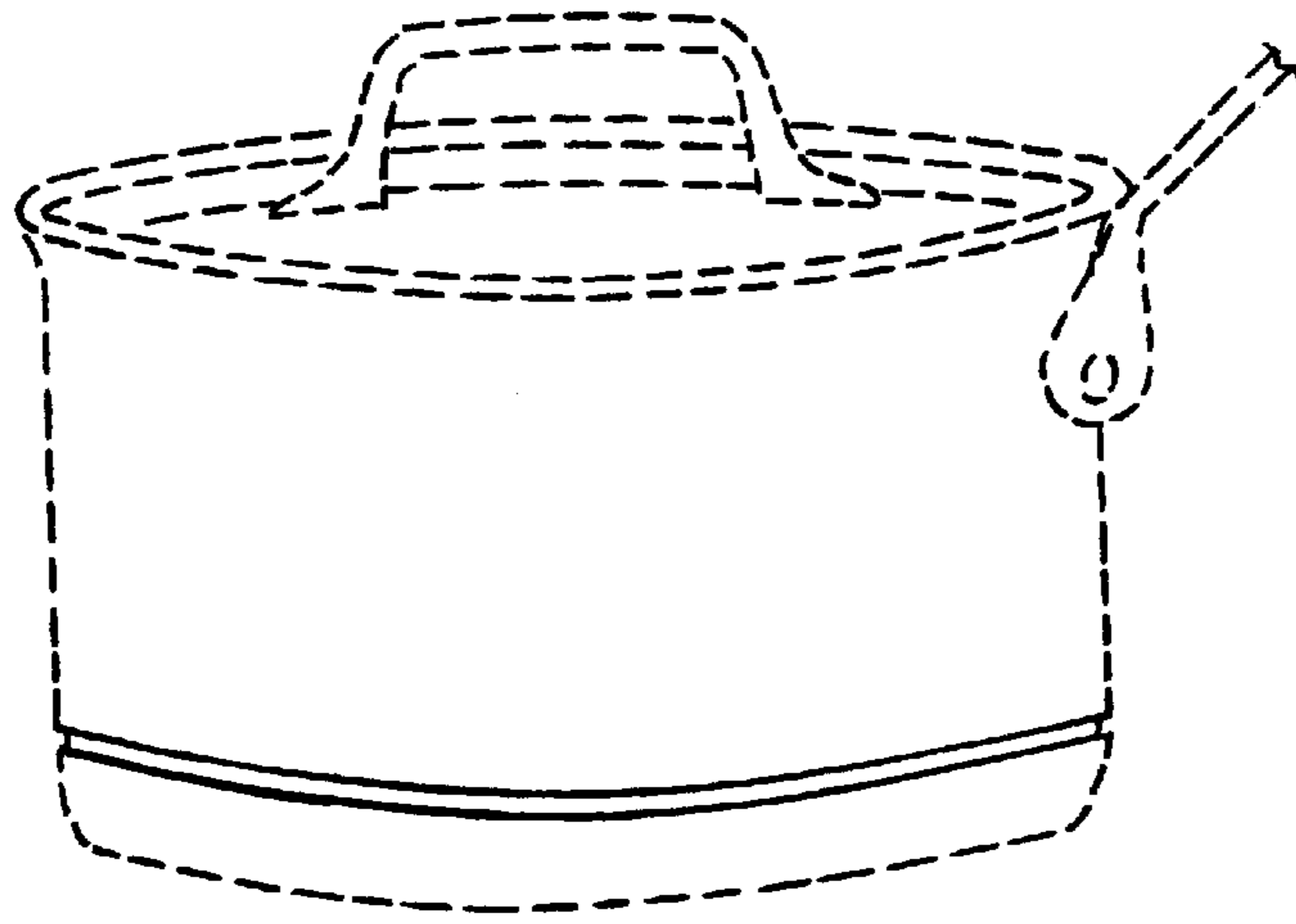

Fig. 10

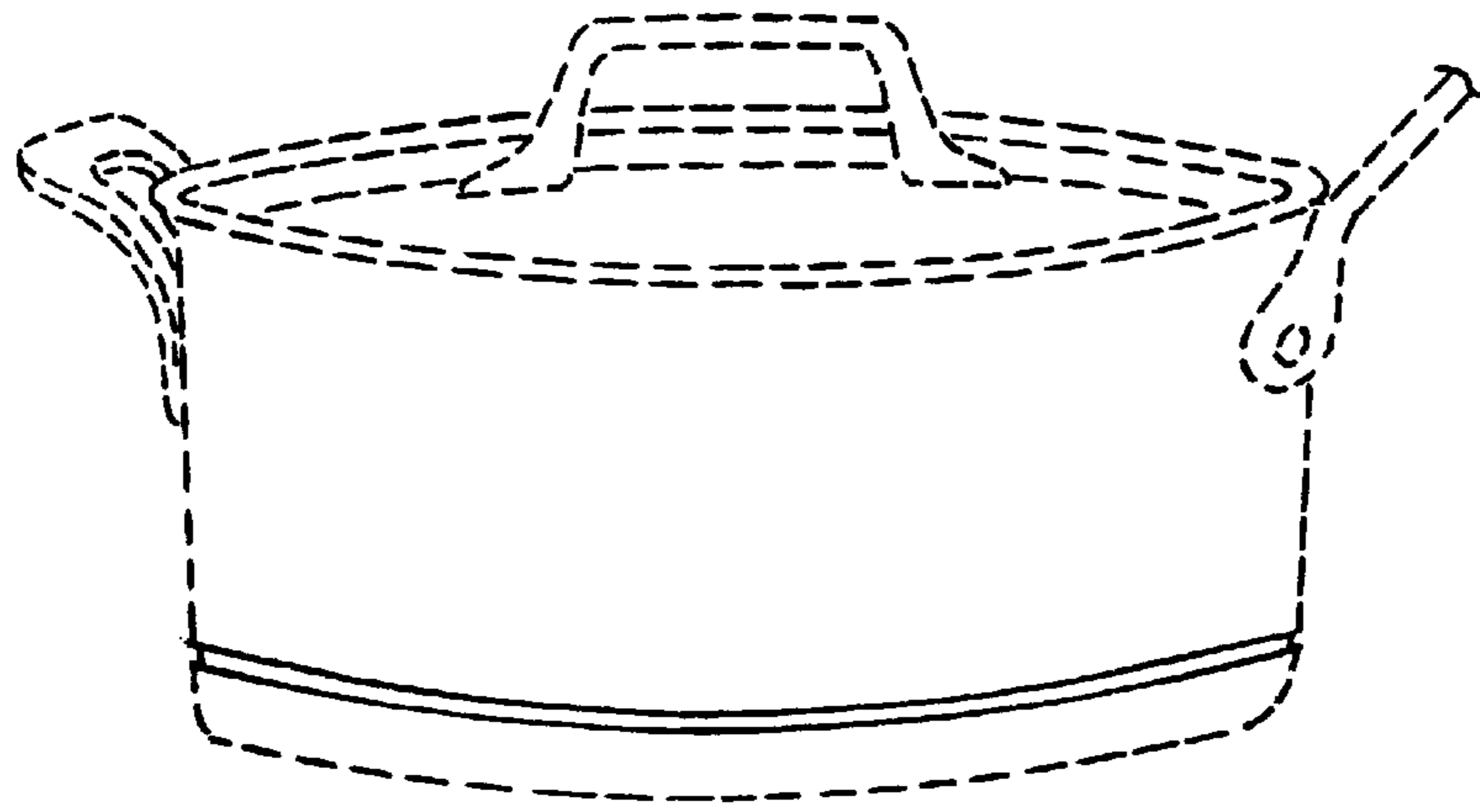

Fig. 11

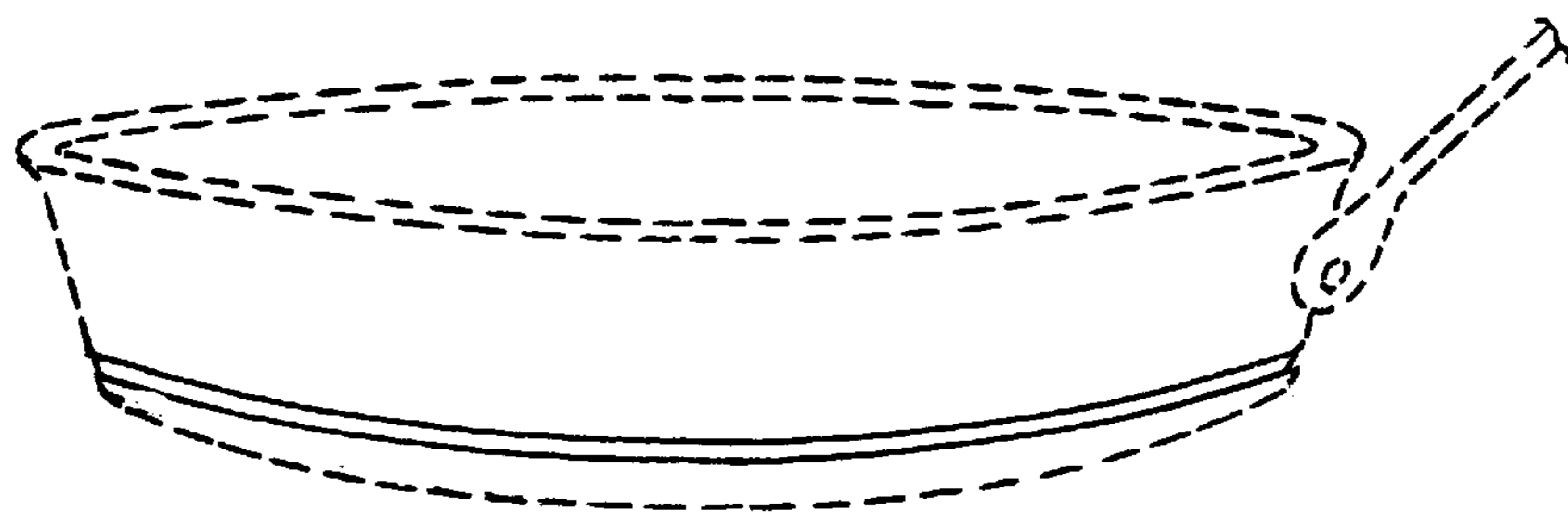

Fig. 12



UNITED STATES PATENT AND TRADEMARK OFFICE  
**CERTIFICATE OF CORRECTION**

PATENT NO. : Des. 474,936 S  
DATED : May 27, 2003  
INVENTOR(S) : William A. Groll

Page 1 of 1

It is certified that error appears in the above-identified patent and that said Letters Patent is hereby corrected as shown below:

Column 2,

Line 27, "indented golen" should read -- intended golden --.

Signed and Sealed this

Nineteenth Day of August, 2003

A handwritten signature in black ink, appearing to read "James E. Rogan", with a horizontal line drawn underneath it.

JAMES E. ROGAN  
*Director of the United States Patent and Trademark Office*