



US00D474924S

(12) **United States Design Patent**  
**Levasseur**

(10) **Patent No.:** **US D474,924 S**

(45) **Date of Patent:** **\*\* May 27, 2003**

(54) **DECORATIVE RESURFACING PANEL FOR CUPBOARDS, DOORS AND DRAWERS**

(76) Inventor: **Lynn Levasseur**, 2335 Boulevard St. Philippe, DuBuisson, Quebec (CA), J9P 4N7

(\*\*) Term: **14 Years**

(21) Appl. No.: **29/153,926**

(22) Filed: **Jan. 14, 2002**

(51) **LOC (7) Cl.** ..... **06-06**

(52) **U.S. Cl.** ..... **D6/492; D6/510**

(58) **Field of Search** ..... D6/396, 397, 432, D6/445, 446, 470, 471, 491, 492, 510, 494; 312/114, 117, 118, 119, 122, 138.1, 204, 348.4

(56) **References Cited**

**U.S. PATENT DOCUMENTS**

- D268,071 S \* 3/1983 James et al. .... D6/511
- 4,804,238 A \* 2/1989 Bischof et al. .... 312/138.1
- D417,098 S \* 11/1999 Teufel et al. .... D6/492
- D446,055 S \* 8/2001 Lucht ..... D6/492
- 6,452,788 B1 \* 9/2002 Crowley ..... 361/683

\* cited by examiner

*Primary Examiner*—Cathron C. Brooks

(74) *Attorney, Agent, or Firm*—Spencer Fane Britt Britt & Brown LLP

(57) **CLAIM**

The ornamental design for a decorative resurfacing panel for cupboards, doors and drawers.

**DESCRIPTION**

FIG. 1 is a front and right side perspective view of the

decorative resurfacing panel showing a first embodiment of my new design having a cylindrically shaped handle aspect

FIG. 2 is a right side elevation view thereof;

FIG. 3 is a front elevation view thereof;

FIG. 4 is a rear elevation view thereof;

FIG. 5 is a bottom elevation view thereof of which the top elevation view is a mirror image thereof;

FIG. 6 is a front and right side perspective view of a second embodiment of the present invention having a rectangularly shaped handle aspect;

FIG. 7 is a right side elevation view of the embodiment of FIG. 6;

FIG. 8 is a front elevation view of the embodiment of FIG. 6;

FIG. 9 is a back elevation view of the embodiment of FIG. 6;

FIG. 10 is a bottom elevation view of the embodiment of FIG. 6 of which the top elevation view is a mirror image thereof;

FIG. 11 is a front perspective view of a third embodiment of the present invention, the sole difference between it and the first embodiment is in the length of the panel; and,

FIG. 12 is a fourth embodiment of the present invention, the sole difference between it and the second embodiment is in the length of the panel.

The broken lines shown are for illustrative purposes only and form no part of the claimed design.

**1 Claim, 3 Drawing Sheets**

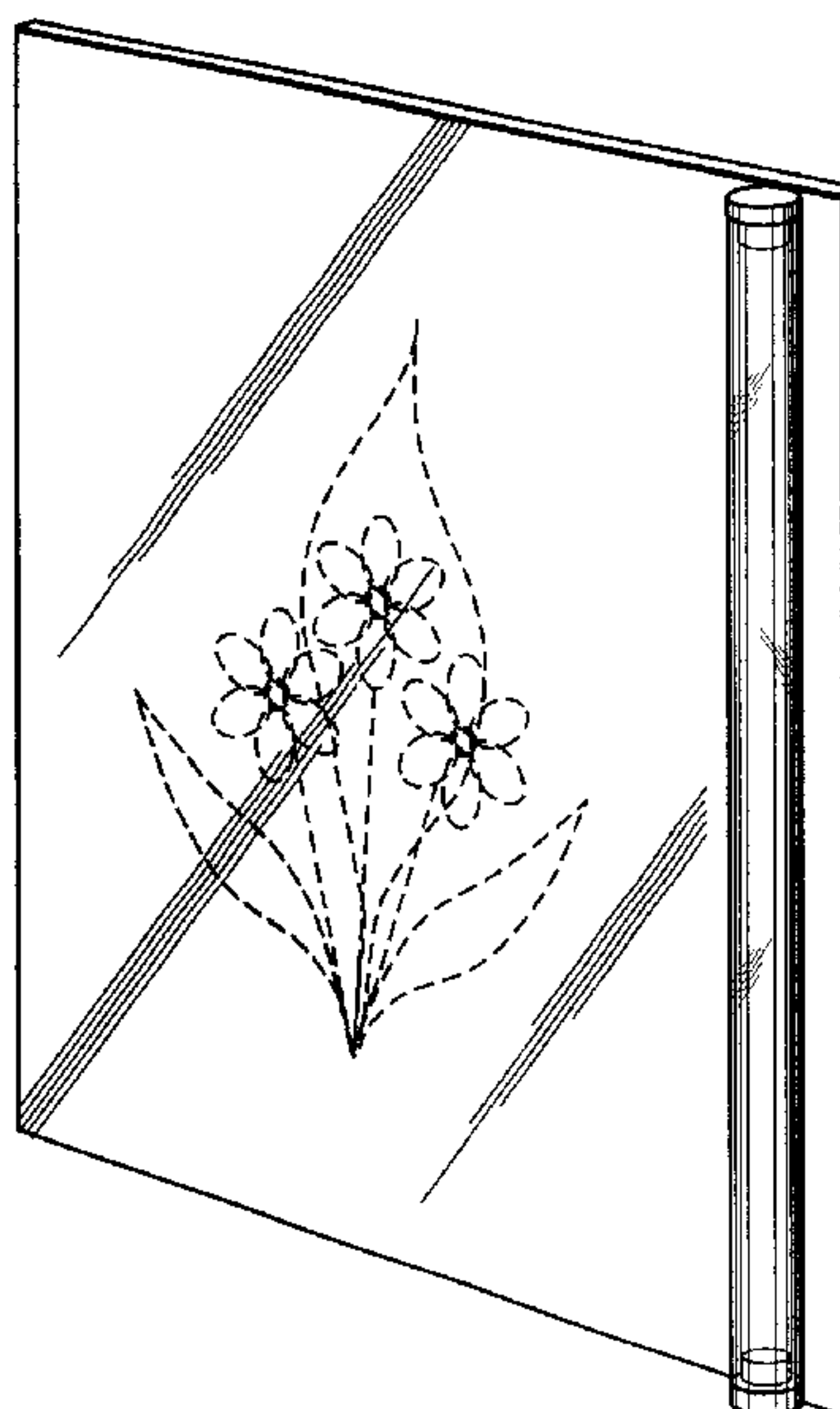

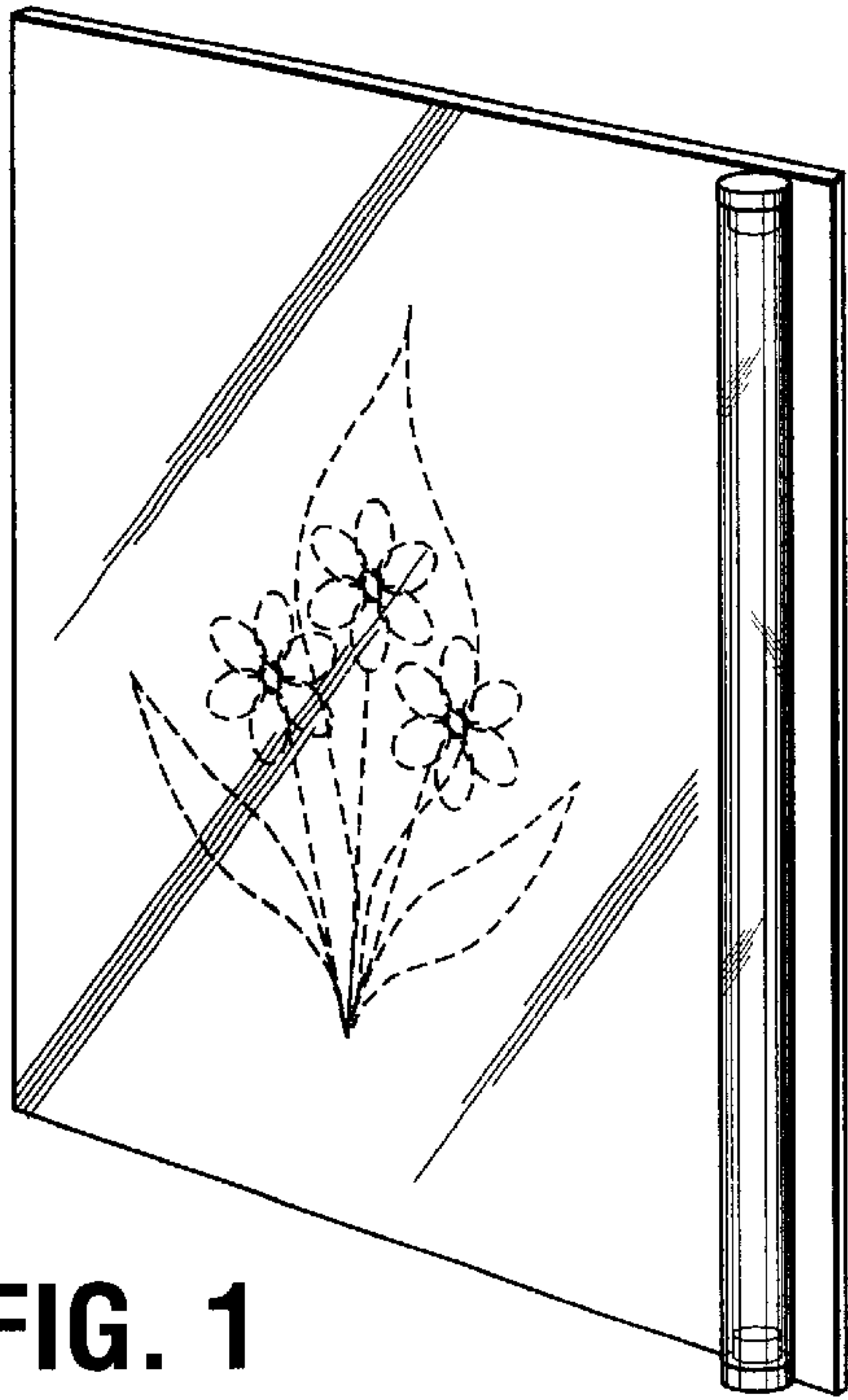

FIG. 1



FIG. 2

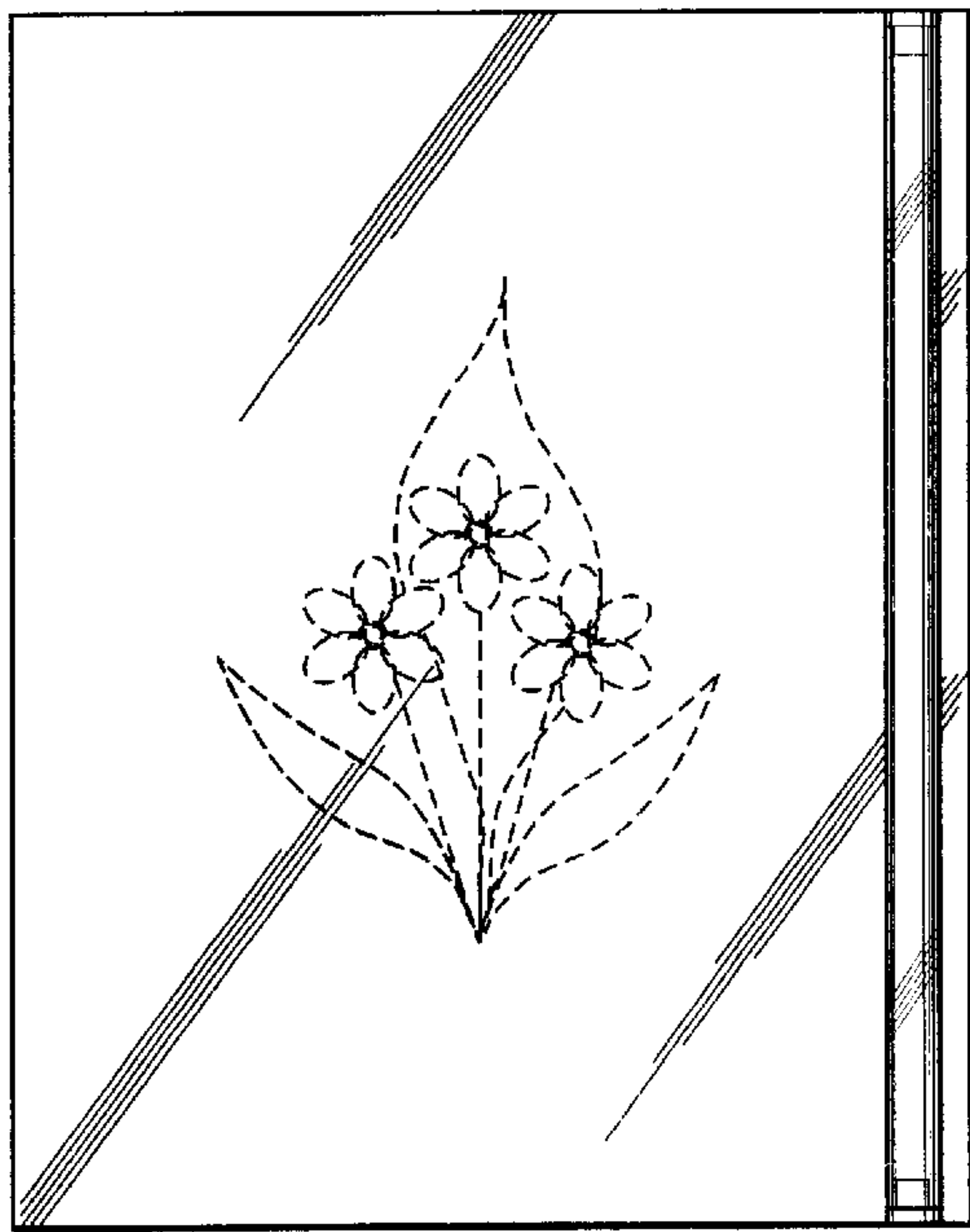

FIG. 3

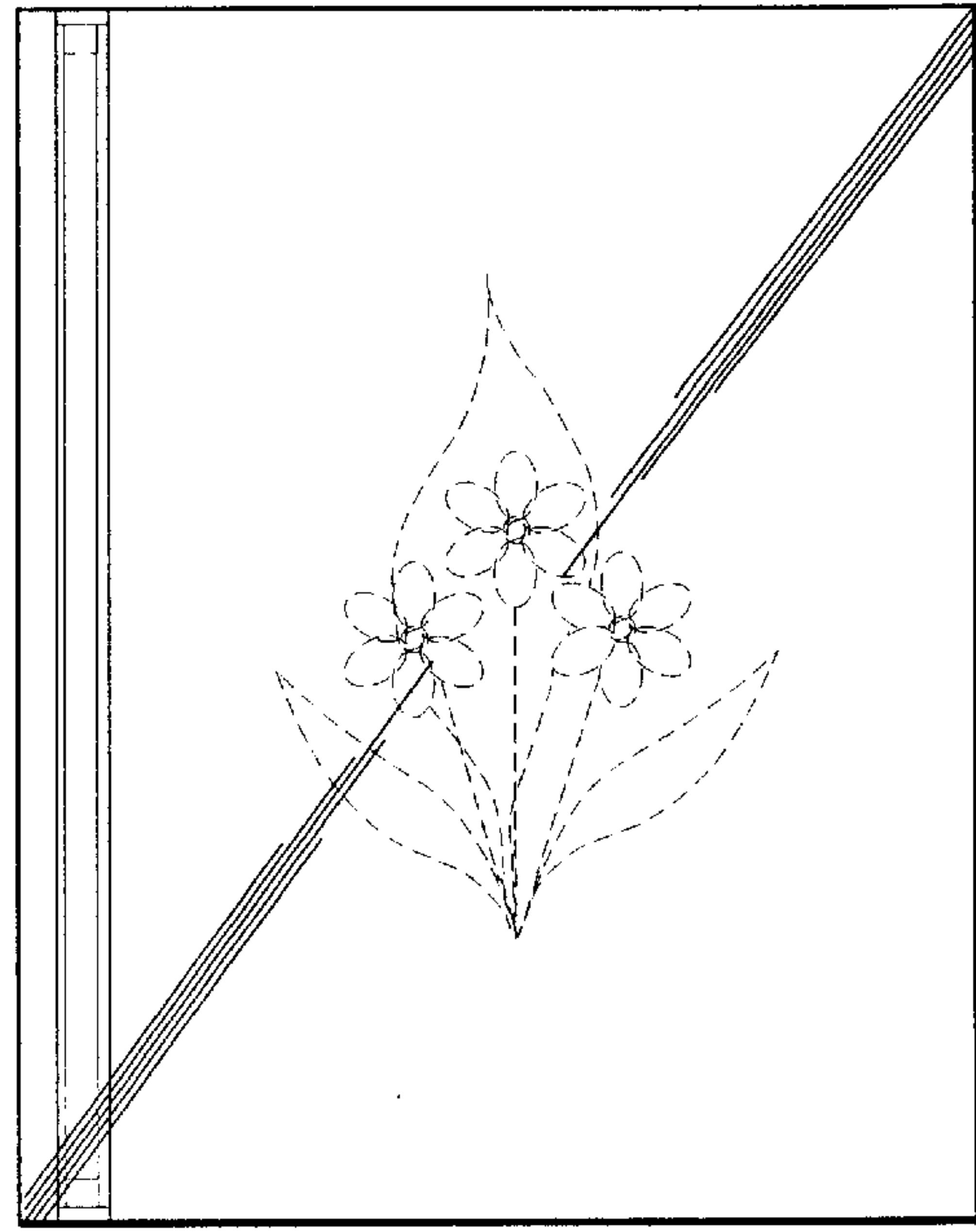

FIG. 4



FIG. 5

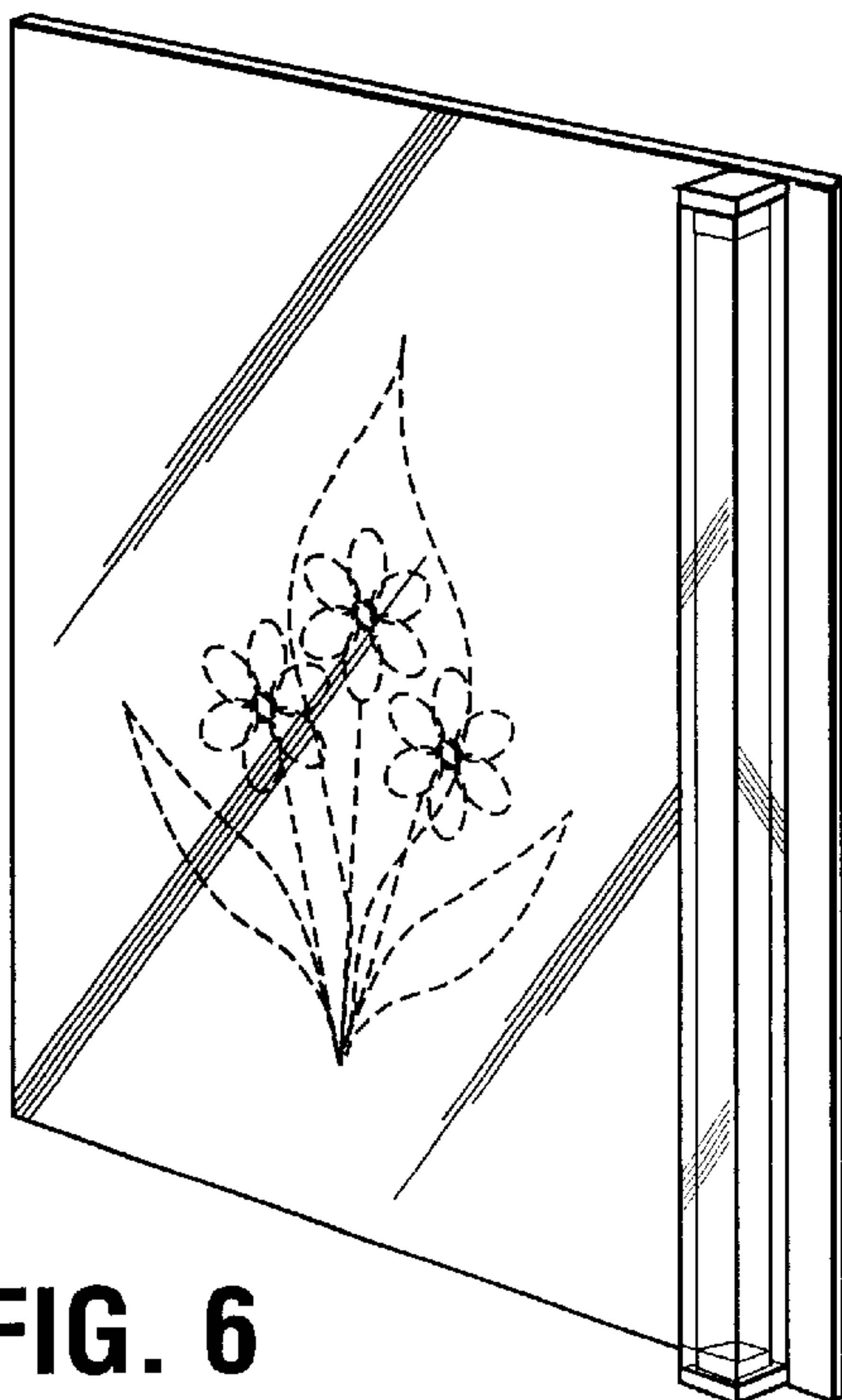

FIG. 6



FIG. 7

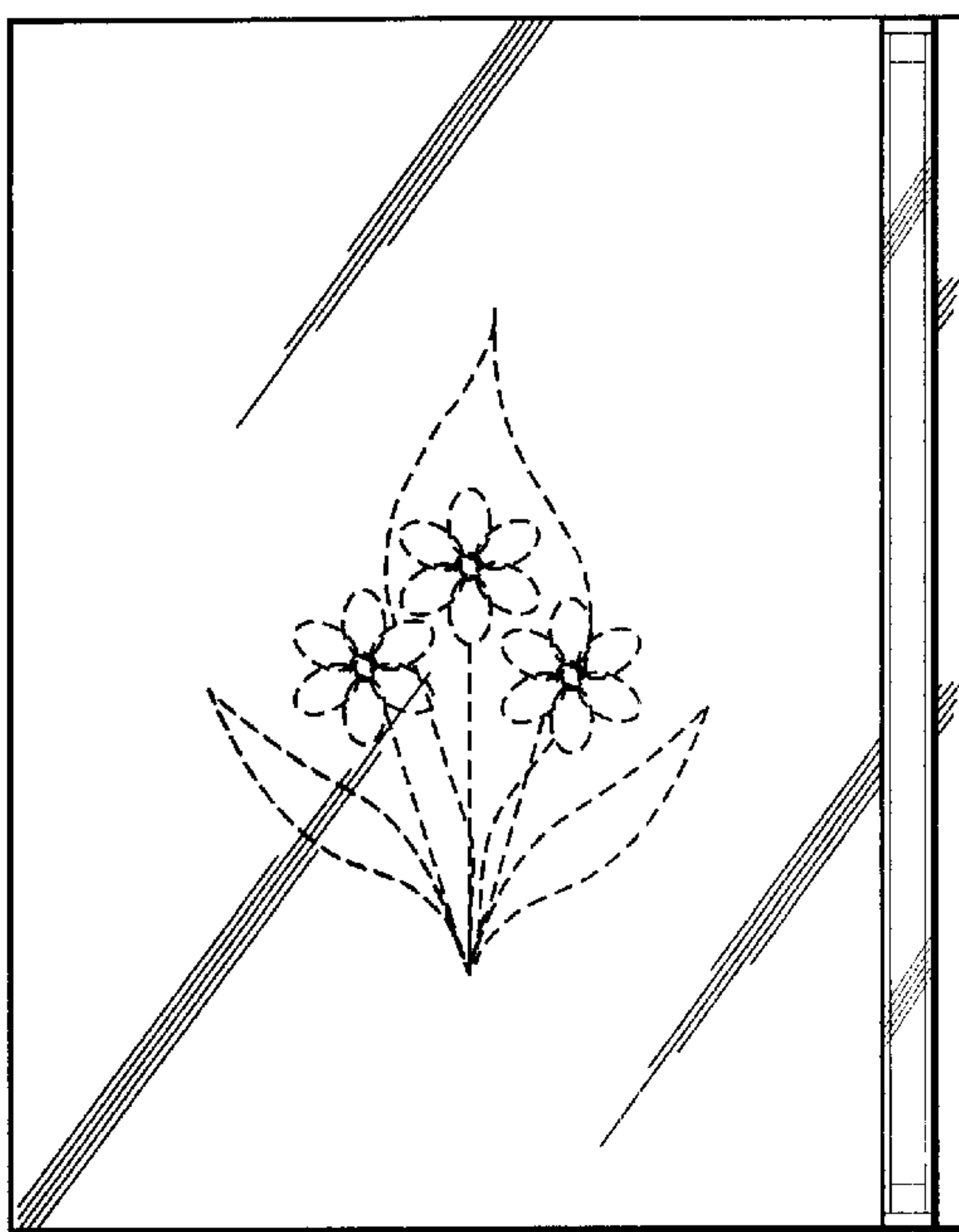

FIG. 8

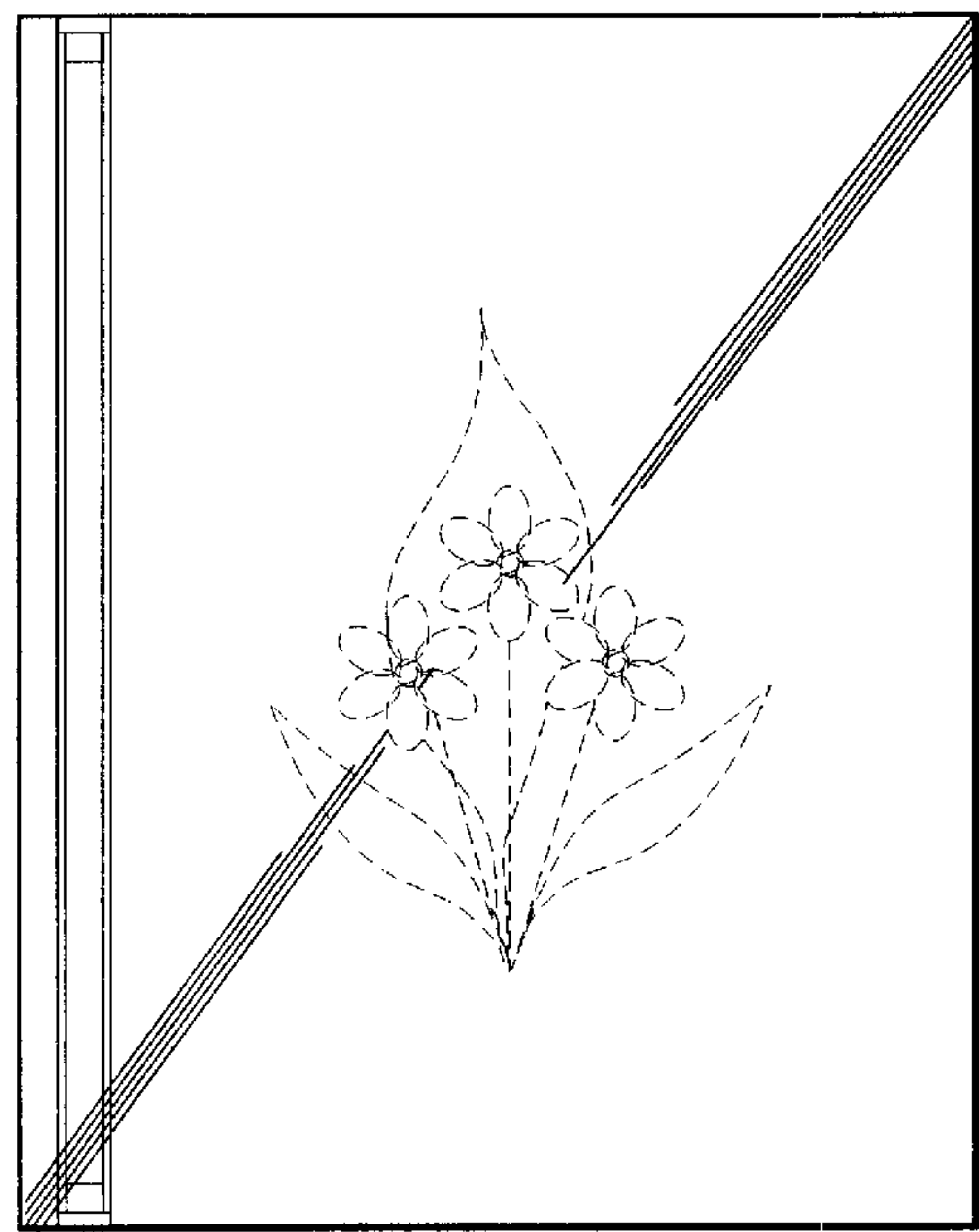
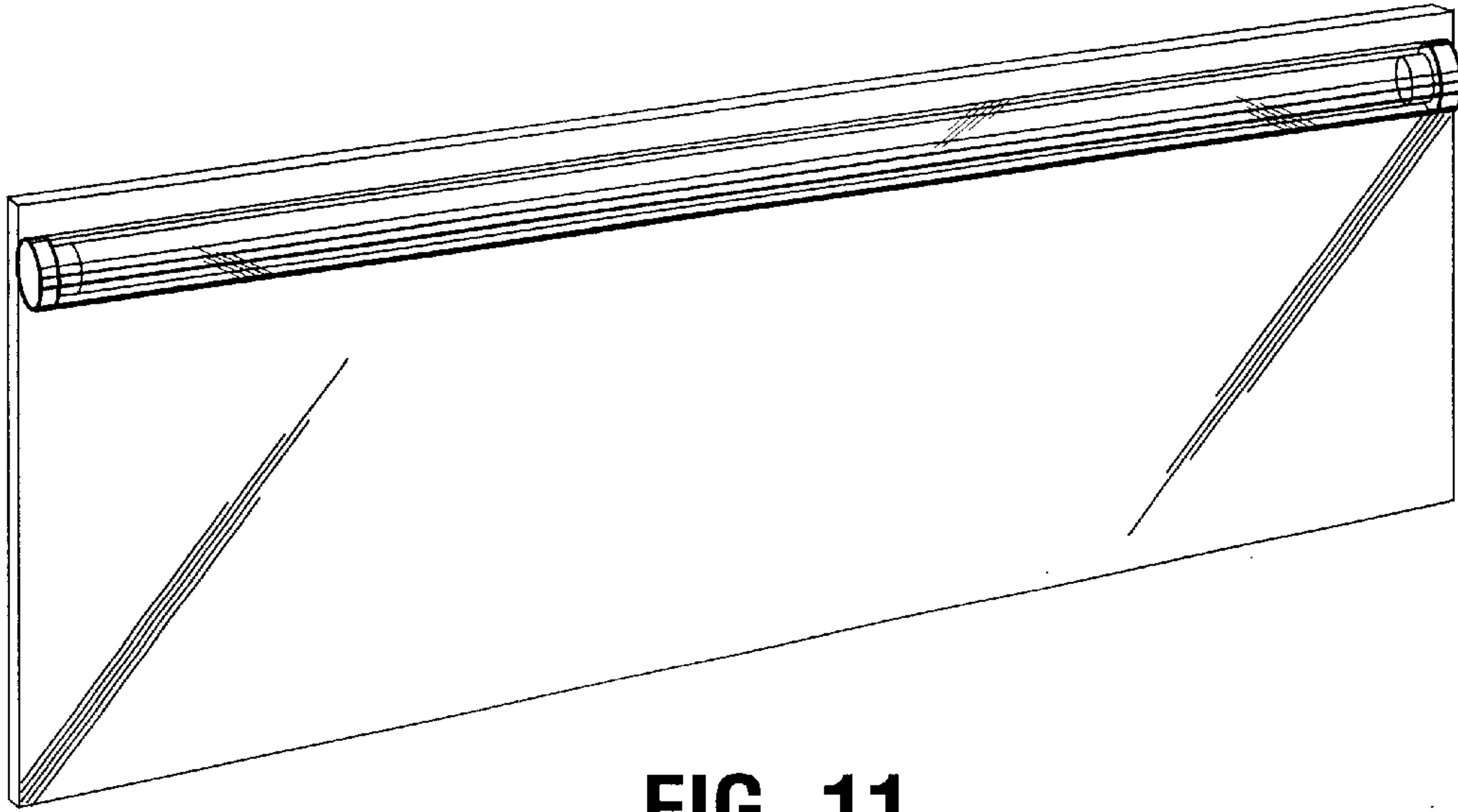

FIG. 9



FIG. 10



**FIG. 11**

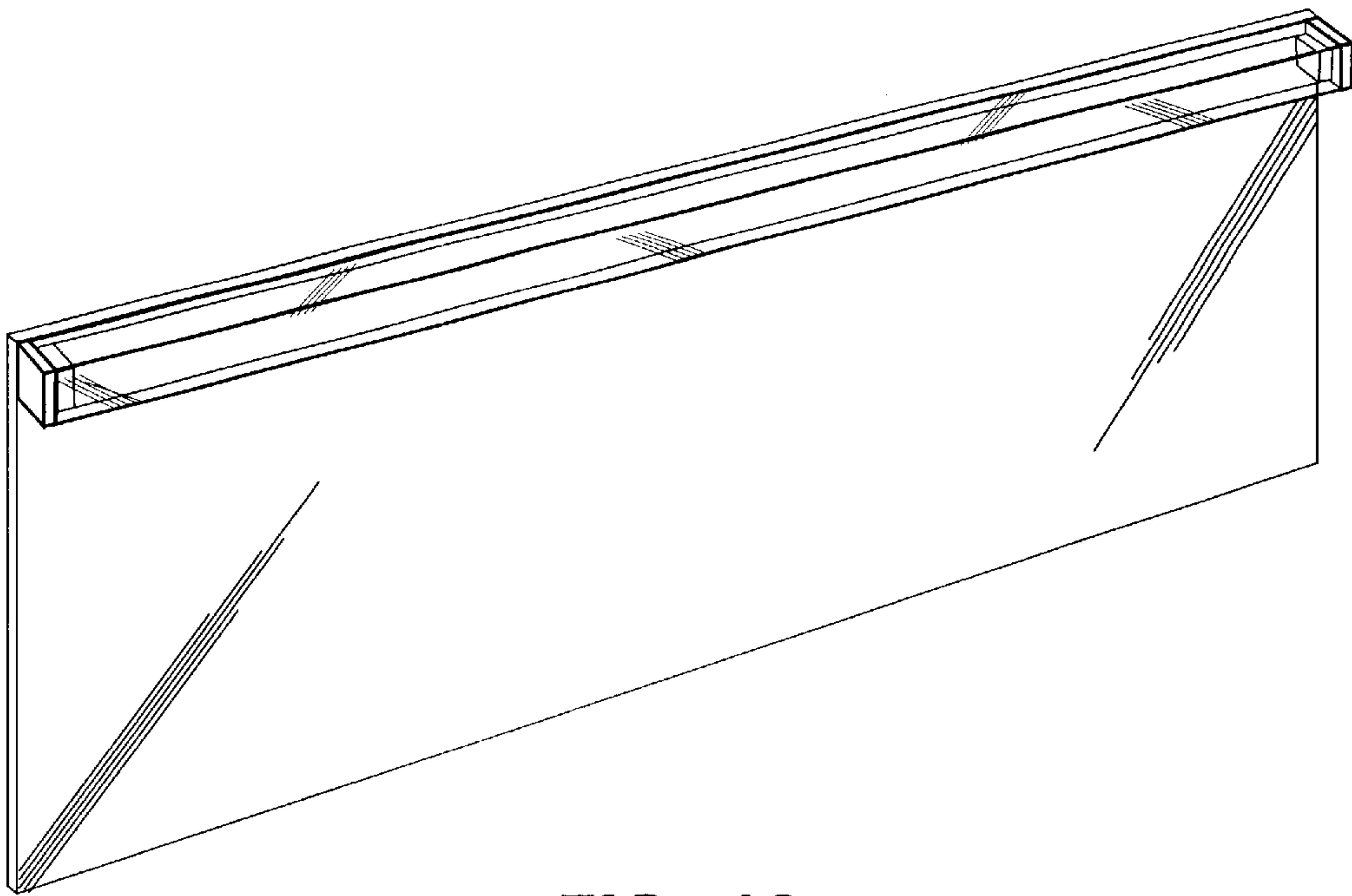

**FIG. 12**