



US00D474905S

(12) **United States Design Patent** (10) **Patent No.:** **US D474,905 S**
Ricci (45) **Date of Patent:** **** May 27, 2003**

- (54) **SOFA**
- (75) Inventor: **Luca Ricci**, Forli (IT)
- (73) Assignee: **De Coro Ltd.**, Fanling (HK)
- (**) Term: **14 Years**
- (21) Appl. No.: **29/163,411**
- (22) Filed: **Jul. 2, 2002**
- (51) **LOC (7) Cl.** **06-01**
- (52) **U.S. Cl.** **D6/381**
- (58) **Field of Search** D6/334, 335, 336,
D6/364, 371, 381, 500, 501, 502; 5/12.1;
297/232

De Coro Ltd. Sofa Model No. 2011, Apr., 2000 at the International Home Furnishing Market in High Point, N.C.
 De Coro Ltd. Sofa Model No. 2009, Apr., 2000 at the International Home Furnishing Market in High Point, N.C.
 De Coro Ltd. Sofa Model No. 2005, Apr., 2000 at the International Home Furnishing Market in High Point, N.C.
 De Coro Ltd. Sofa Model No. 2004, Apr., 2000 at the International Home Furnishing Market in High Point, N.C.
 De Coro Ltd. Sofa Model No. 224, Apr., 1999 at the International Home Furnishing Market in High Point, N.C.
 De Coro Ltd. Sofa Model No. 154, Apr., 1998 at the International Home Furnishing Market in High Point, N.C.
 De Coro Ltd. Sofa Model No. 133, Apr., 1998 at the International Home Furnishing Market in High Point, N.C.
 De Coro Ltd. Sofa Model No. 105, Apr., 1998 at the International Home Furnishing Market in High Point, N.C.

* cited by examiner

Primary Examiner—Gary D. Watson
 (74) *Attorney, Agent, or Firm*—Luce, Forward, Hamilton & Scripps LLP

(56) **References Cited**

U.S. PATENT DOCUMENTS

D362,355 S	9/1995	Natuzzi et al.	
D362,560 S	9/1995	Natuzzi et al.	
D372,808 S	* 8/1996	Natuzzi et al. D6/381
D381,217 S	7/1997	Chandler	
D414,954 S	10/1999	Christa et al.	
D424,316 S	* 5/2000	Natuzzi et al. D6/381
D438,028 S	* 2/2001	Natuzzi et al. D6/381
D446,041 S	* 8/2001	Natuzzi et al. D6/381
D448,183 S	* 9/2001	Brisson D6/335

OTHER PUBLICATIONS

De Coro Ltd. Sofa Model No. 2144, Oct., 2001 at the International Home Furnishing Market in High Point, N.C.
 De Coro Ltd. Sofa Model No. 2117, Oct., 2001 at the International Home Furnishing Market in High Point, N.C.
 De Coro Ltd. Sofa Model No. 2116, Oct., 2001 at the International Home Furnishing Market in High Point, N.C.
 De Coro Ltd. Sofa Model No. 2088, Apr., 2000 at the International Home Furnishing Market in High Point, N.C.
 De Coro Ltd. Sofa Model No. 2072, Apr., 2000 at the International Home Furnishing Market in High Point, N.C.
 De Coro Ltd. Sofa Model No. 2072, Apr., 2000 at the International Home Furnishing Market in High Point, N.C.
 De Coro Ltd. Sofa Model No. 2017, Apr., 2000 at the International Home Furnishing Market in High Point, N.C.
 De Coro Ltd. Sofa Model No. 2015, Apr., 2000 at the International Home Furnishing Market in High Point, N.C.

(57) **CLAIM**

The ornamental design for a sofa, as shown and described.

DESCRIPTION

FIG. 1 is a front, right perspective view of a sofa showing my new design;
 FIG. 2 is a rear, left perspective view of the embodiment of FIG. 1;
 FIG. 3 is a front elevation view of the embodiment of FIG. 1;
 FIG. 4 is a left, side elevation view of the embodiment of FIG. 1, with the right side elevational view being a mirror image thereof;
 FIG. 5 is a rear elevation view of the embodiment of FIG. 1;
 FIG. 6 is a front elevation view of a second embodiment of the sofa depicted in FIG. 1; and,
 FIG. 7 is a rear elevation view of the embodiment of FIG. 6.

The broken line disclosure is for illustrative purposes only and forms no part of the claimed design.

1 Claim, 3 Drawing Sheets

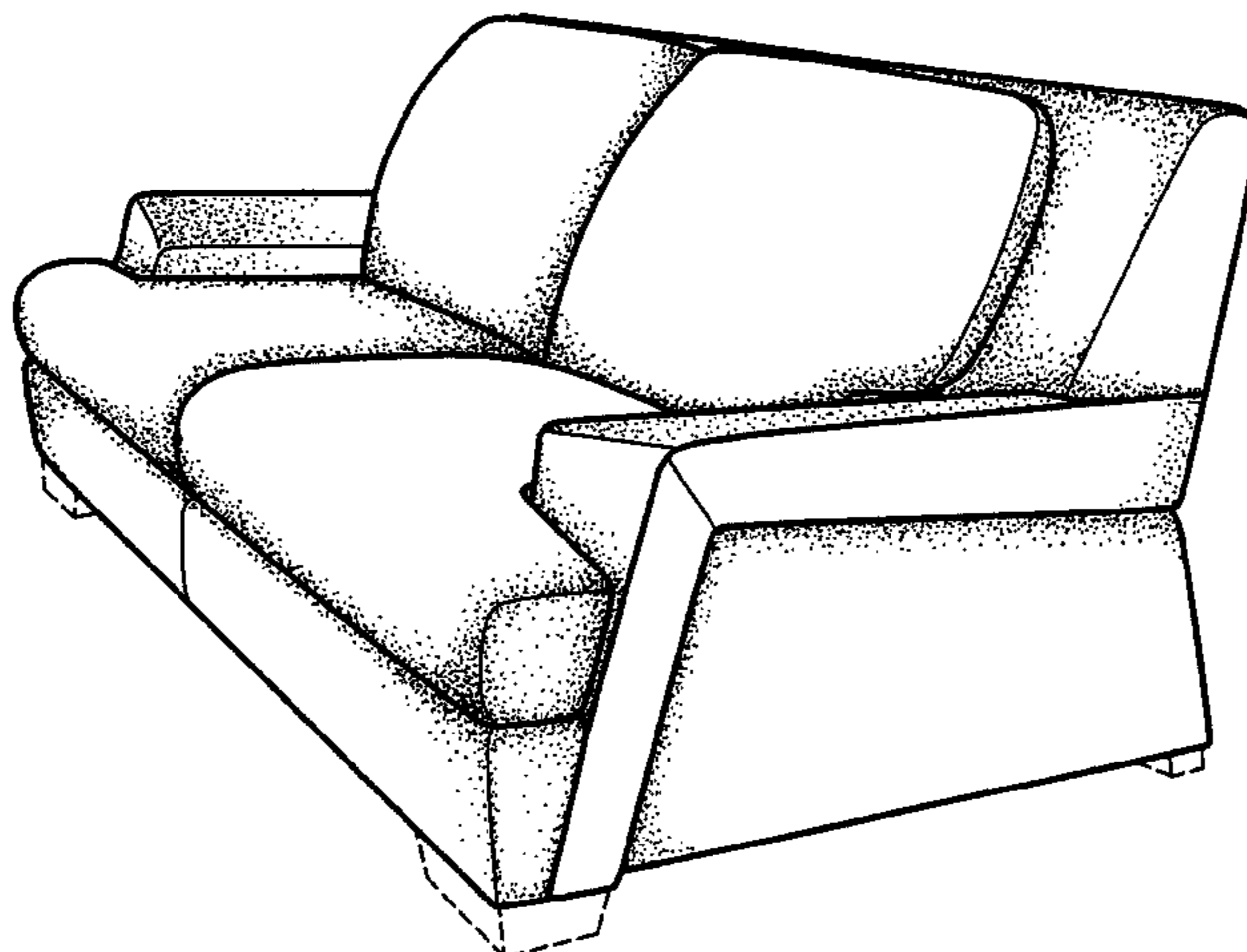

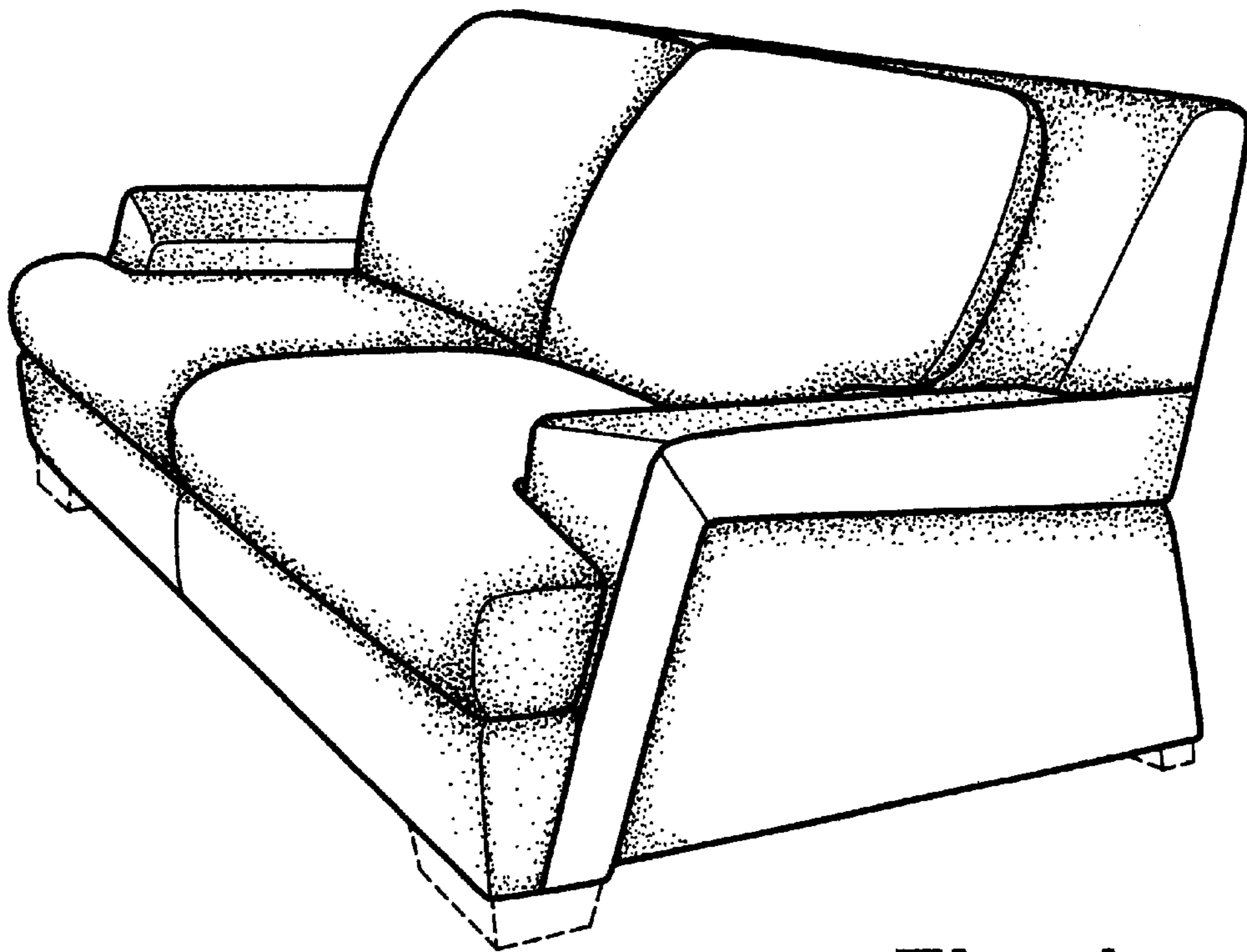

Fig. 1

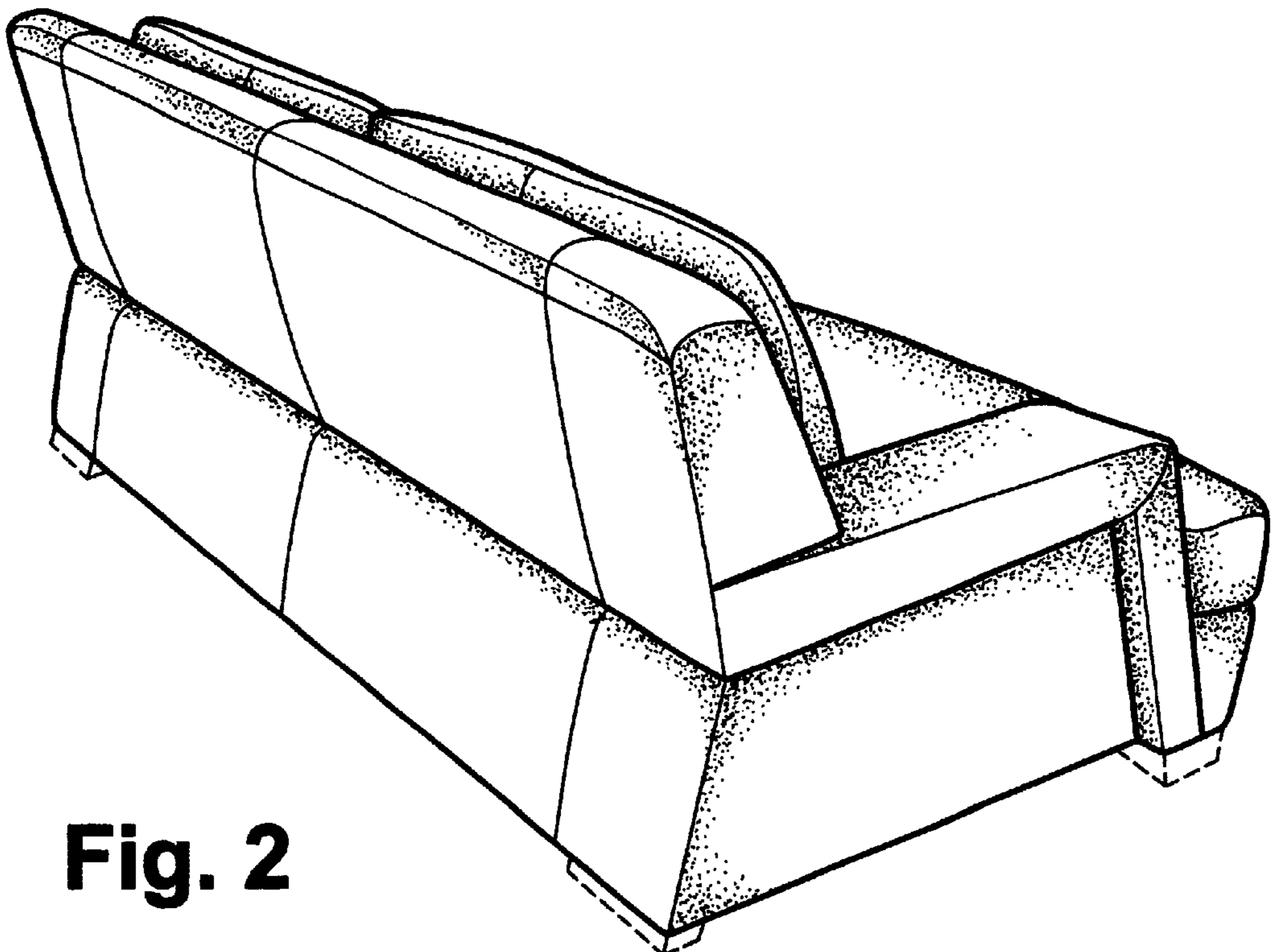

Fig. 2

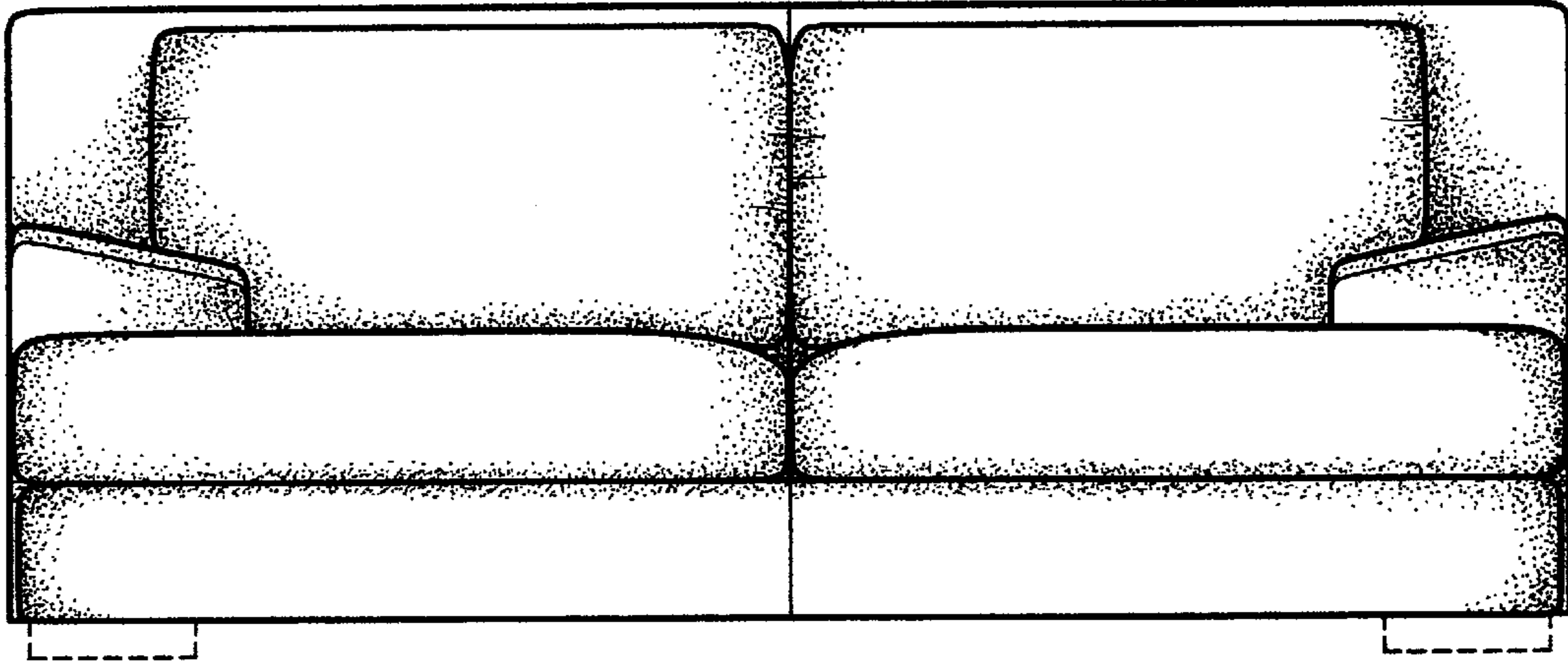

Fig. 3

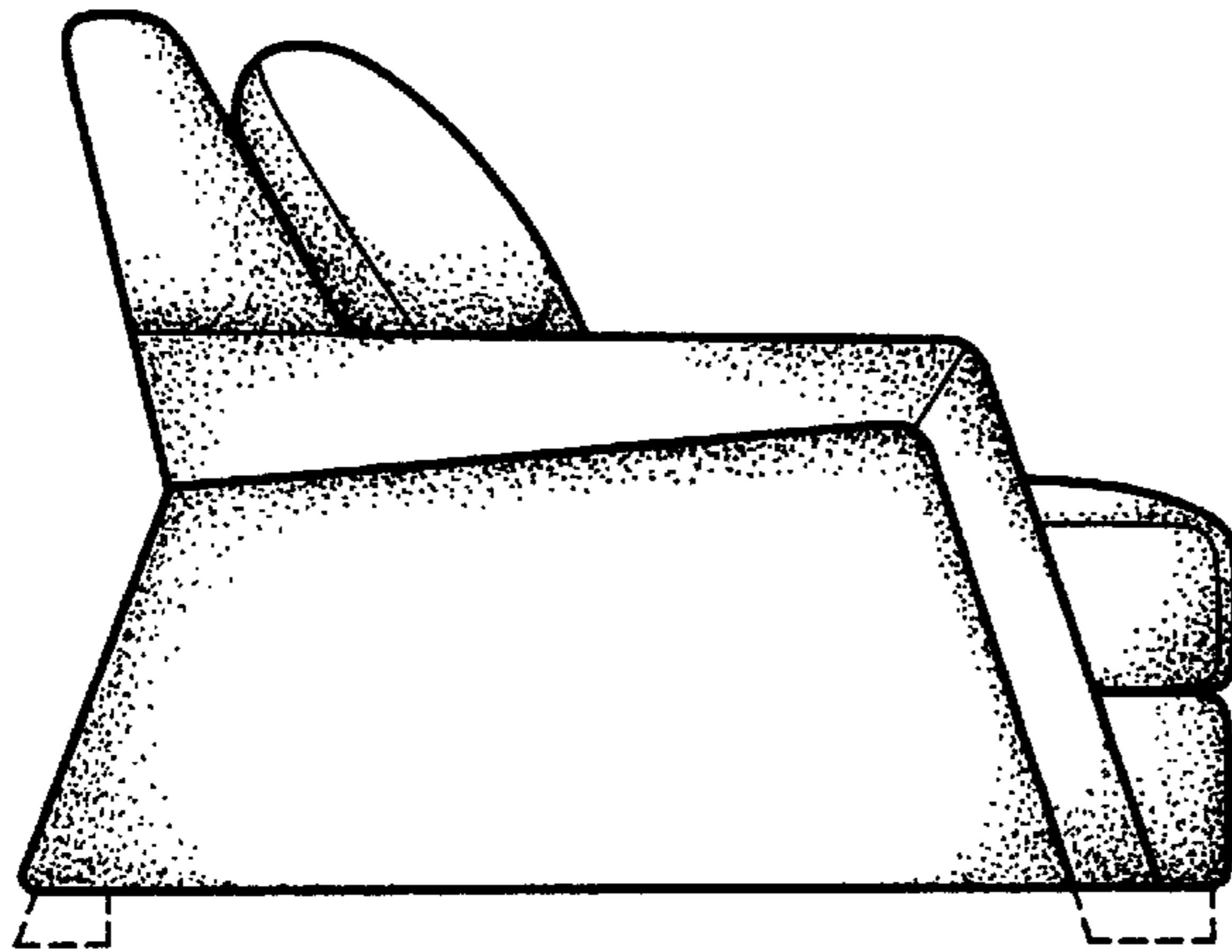

Fig. 4

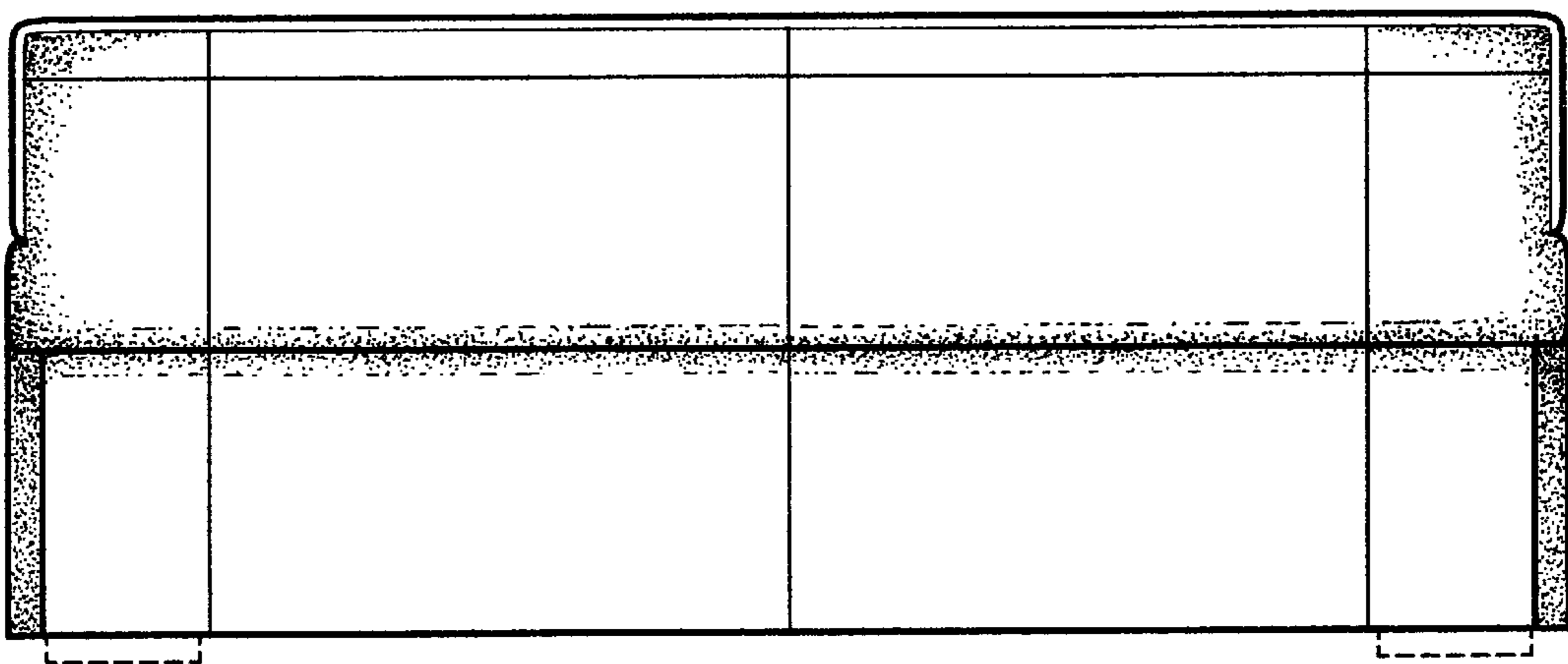

Fig. 5

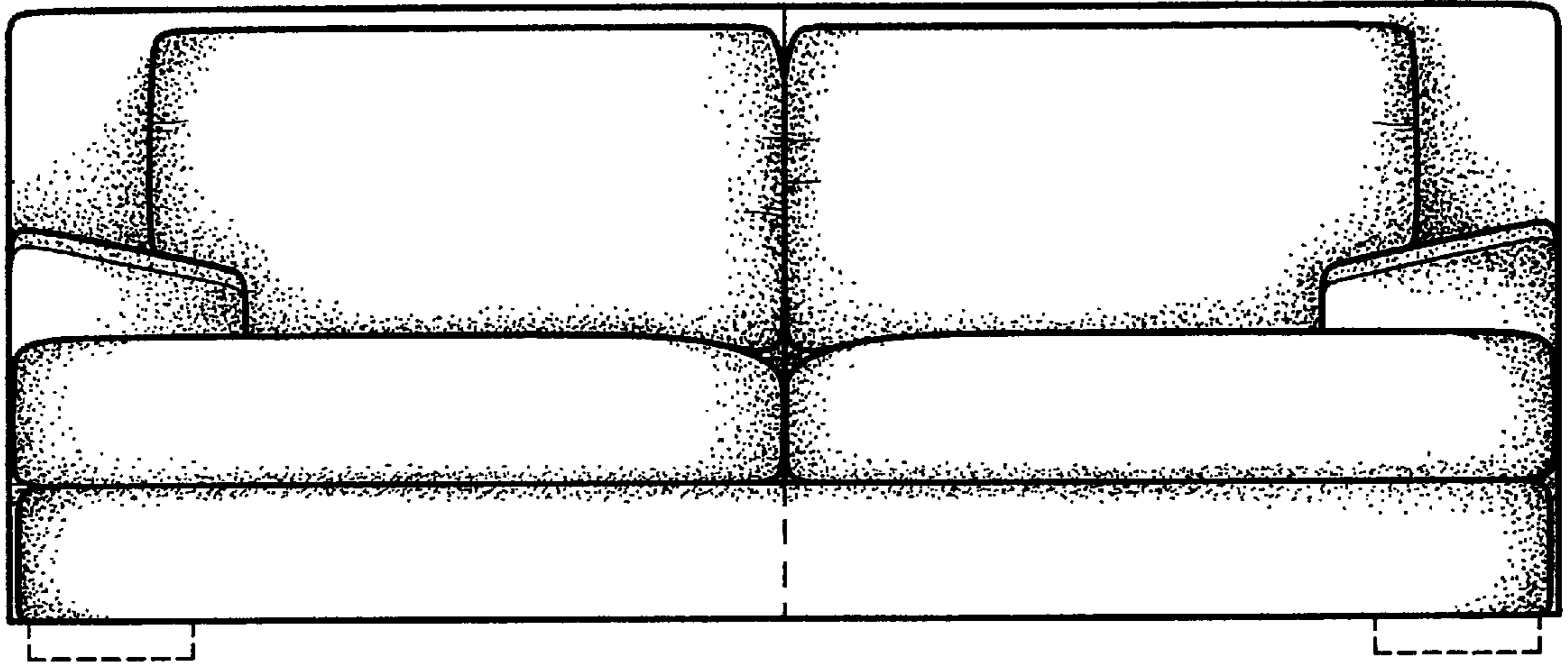

Fig. 6

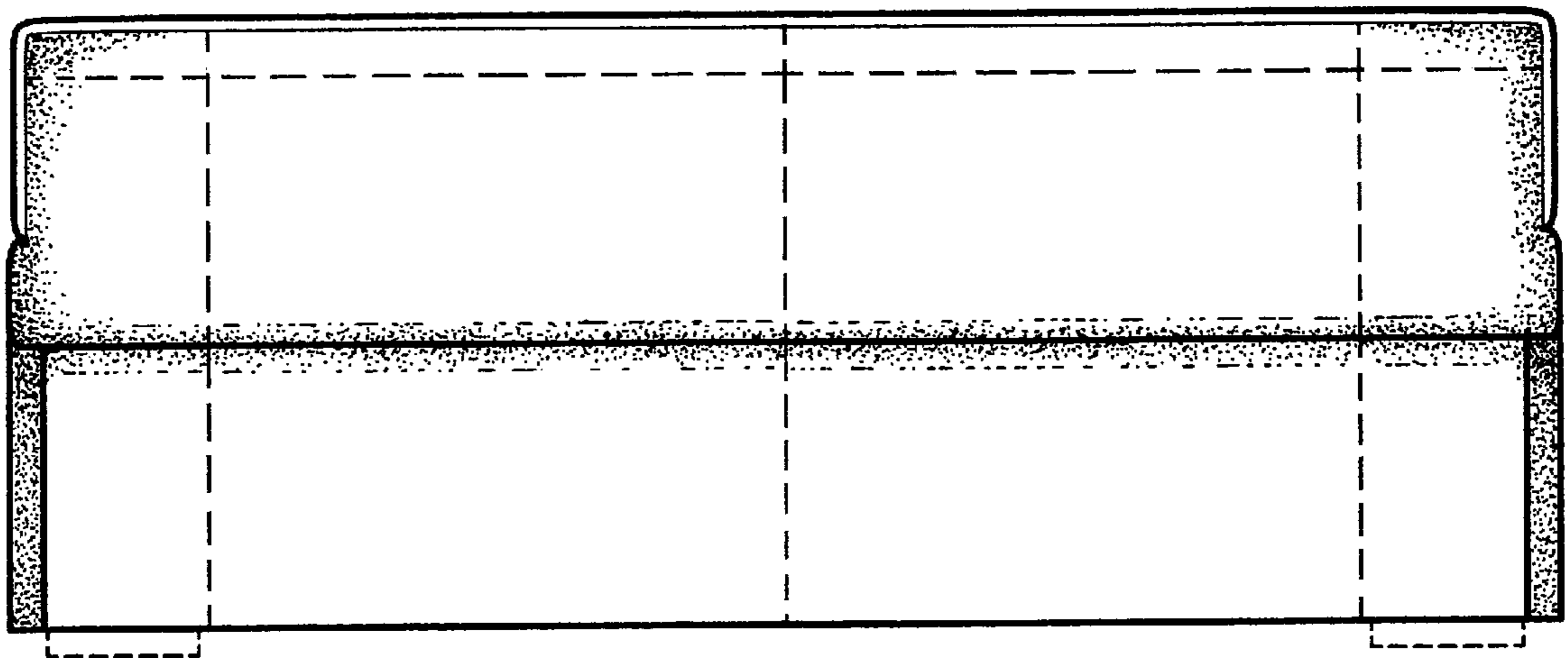

Fig. 7