



US00D474889S

(12) **United States Design Patent**
Ko

(10) **Patent No.:** **US D474,889 S**

(45) **Date of Patent:** **** May 27, 2003**

(54) **COSMETIC CASE**

(75) **Inventor:** **Chin-Der Ko**, Tainan (TW)

(73) **Assignee:** **Mei Kuai Cosmetics Co., Ltd.**, Tainan (TW)

(**) **Term:** **14 Years**

(21) **Appl. No.:** **29/164,621**

(22) **Filed:** **Jul. 30, 2002**

(51) **LOC (7) Cl.** **03-01**

(52) **U.S. Cl.** **D3/296; D3/901; D3/295**

(58) **Field of Search** **D3/272, 273, 294, D3/295, 296, 297, 298, 901, 903, 283; 206/6.1, 566, 823; 220/503, 504, 505; 312/290**

(56) **References Cited**

U.S. PATENT DOCUMENTS

- D322,162 S * 12/1991 Wu D3/296
- D358,708 S * 5/1995 Ko D3/276
- D361,430 S * 8/1995 Mohundro D3/297

- D418,298 S * 1/2000 Wolf D3/297
- D443,137 S * 6/2001 Lai D3/295
- D454,687 S * 3/2002 Wolf D3/275

* cited by examiner

Primary Examiner—Philip S. Hyder

(74) *Attorney, Agent, or Firm*—Rosenberg, Klein & Lee

(57) **CLAIM**

The ornamental design for a cosmetic case, as shown and described.

DESCRIPTION

- FIG. 1 is a perspective view of a cosmetic case showing my new design;
- FIG. 2 is a front elevational view thereof.
- FIG. 3 is a rear elevational view thereof.
- FIG. 4 is a left side elevational view thereof.
- FIG. 5 is a right side elevational view thereof.
- FIG. 6 is a top plan view thereof.
- FIG. 7 is a bottom plan view thereof; and,
- FIG. 8 is a view showing the cap of the design opened.

1 Claim, 6 Drawing Sheets

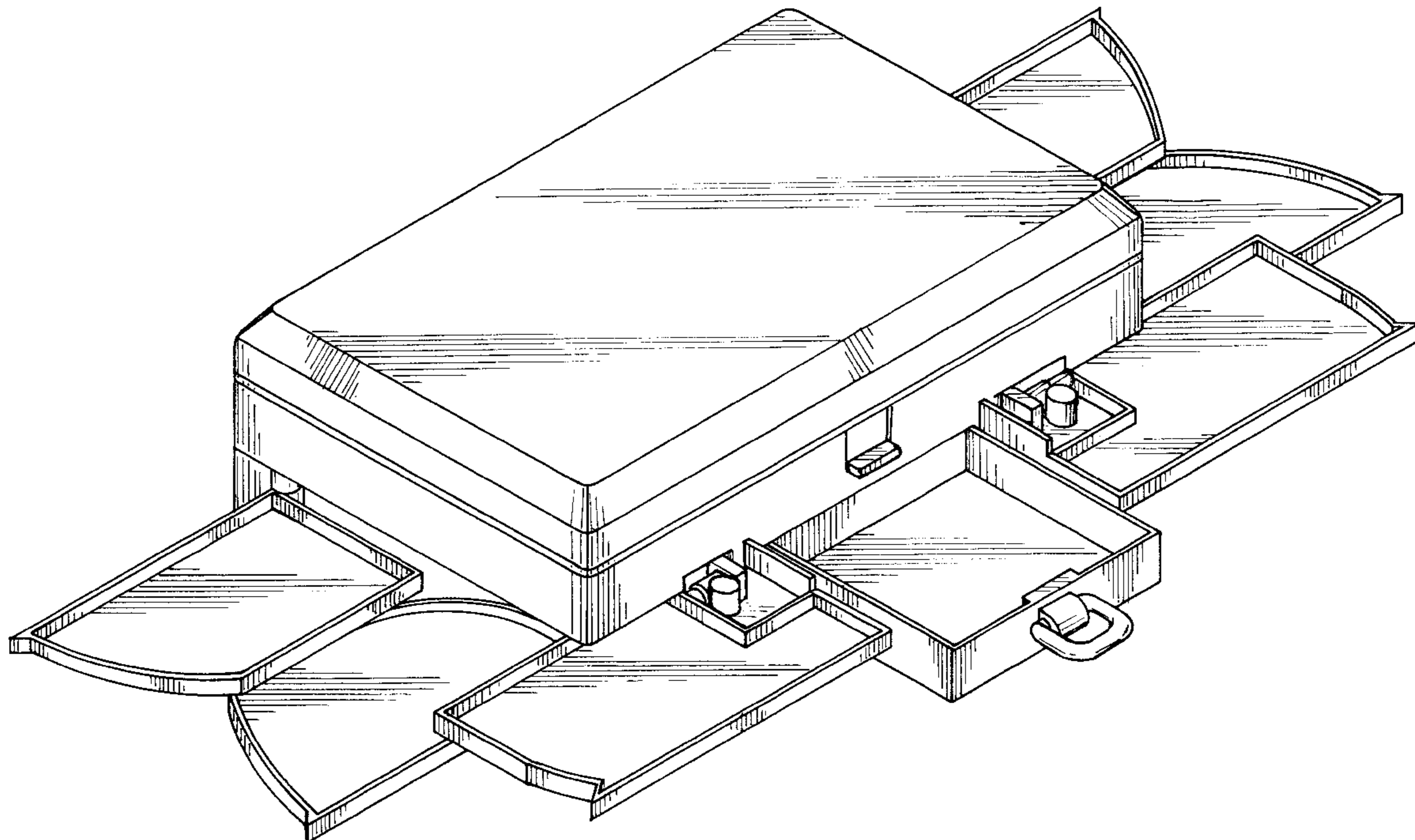

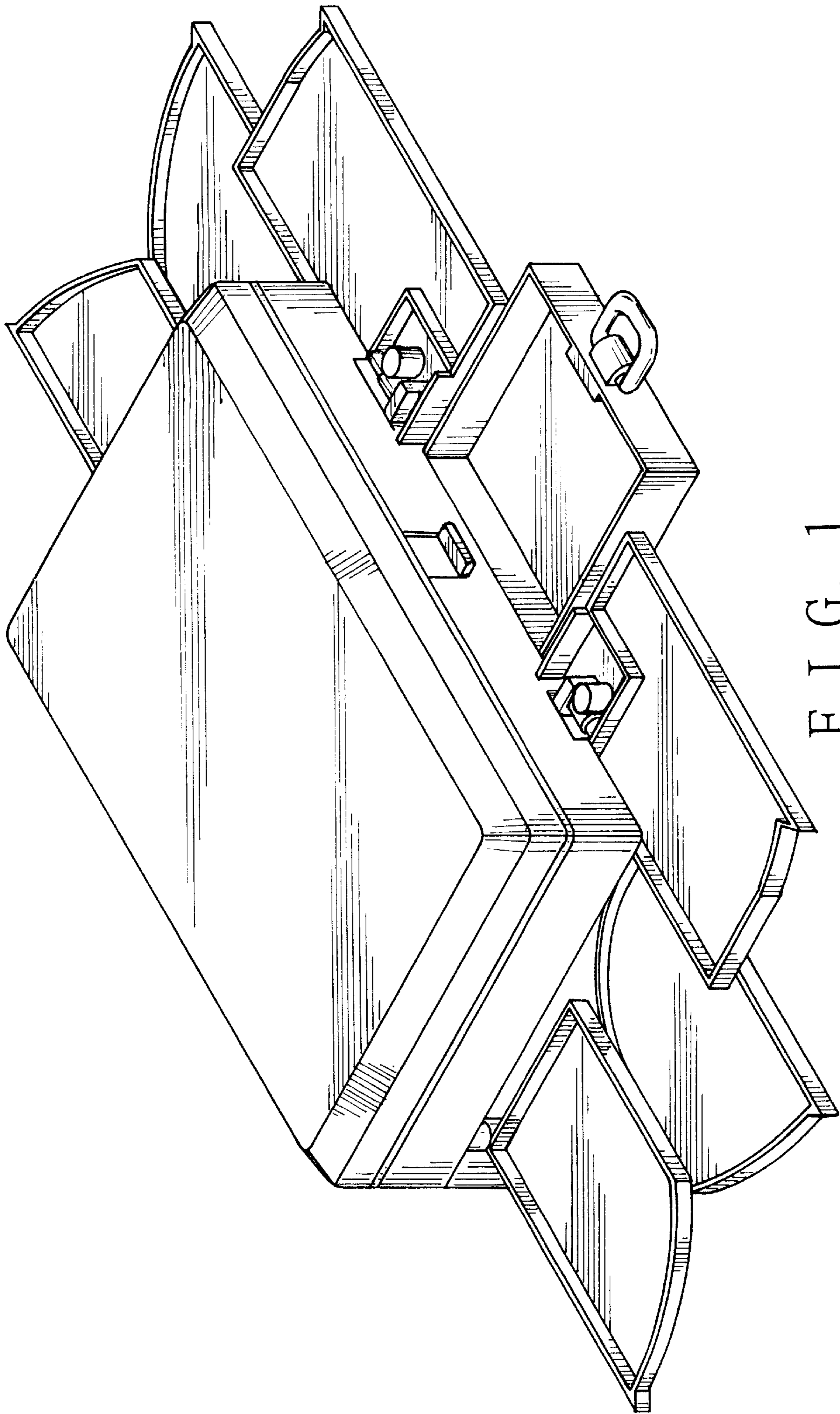

FIG. 1

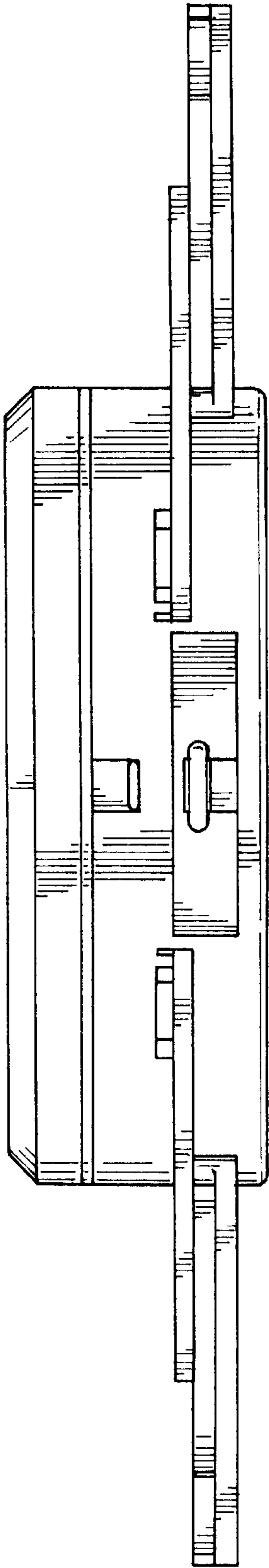

FIG. 2

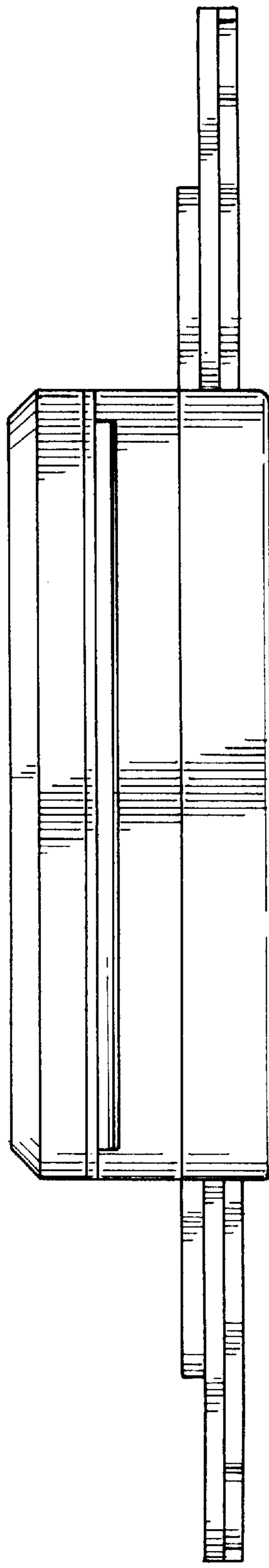

FIG. 3

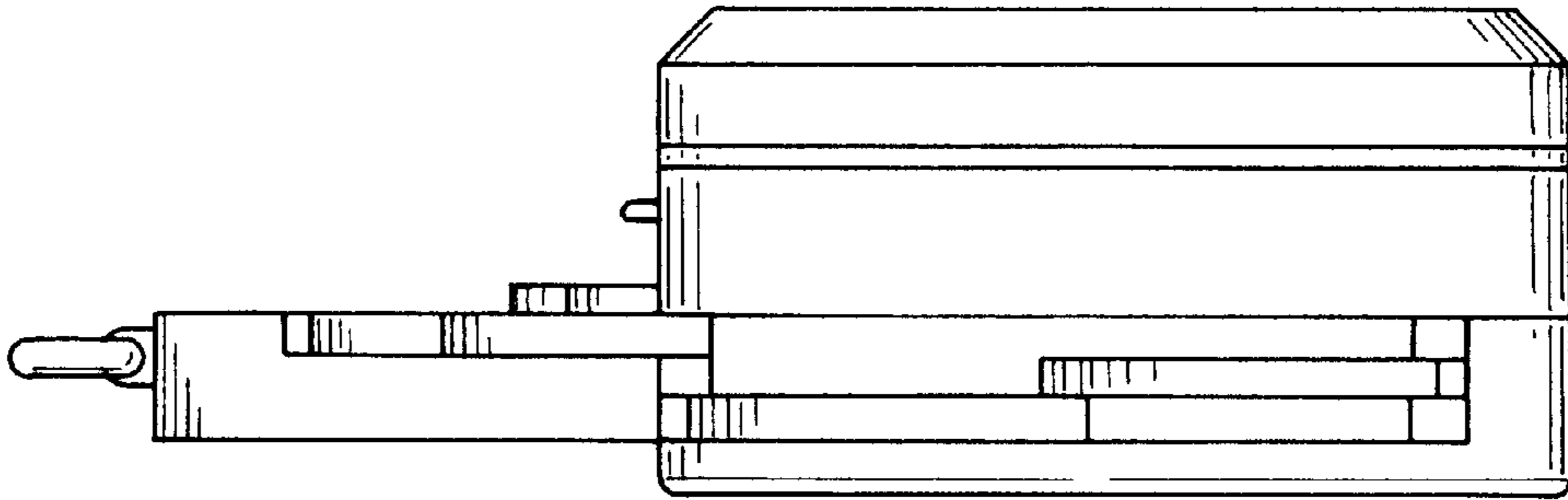

FIG. 5

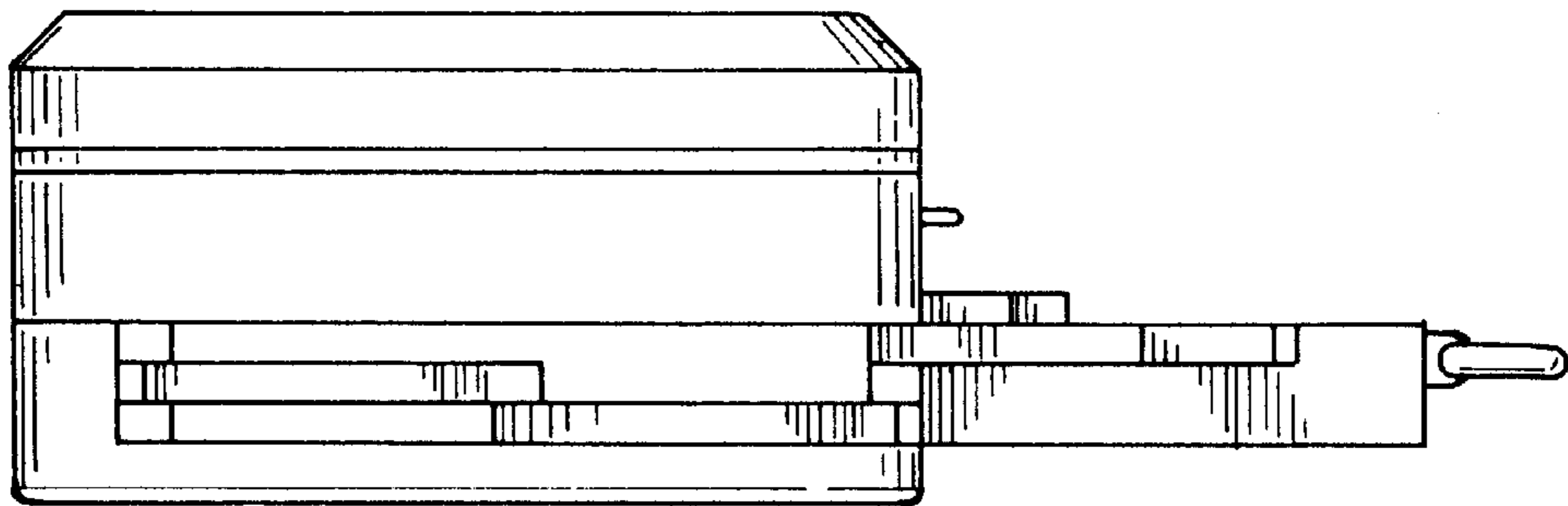

FIG. 4

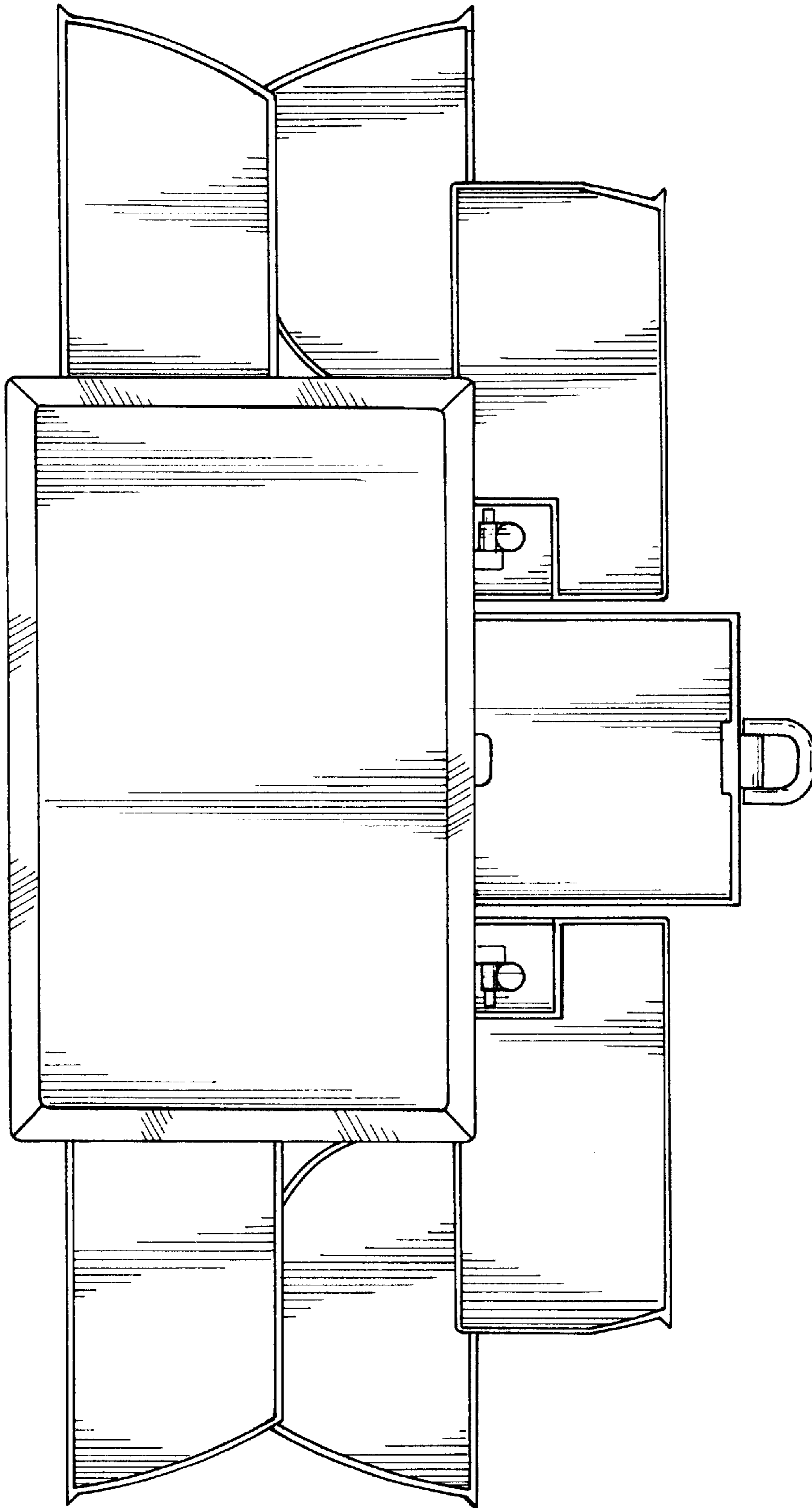

FIG. 6

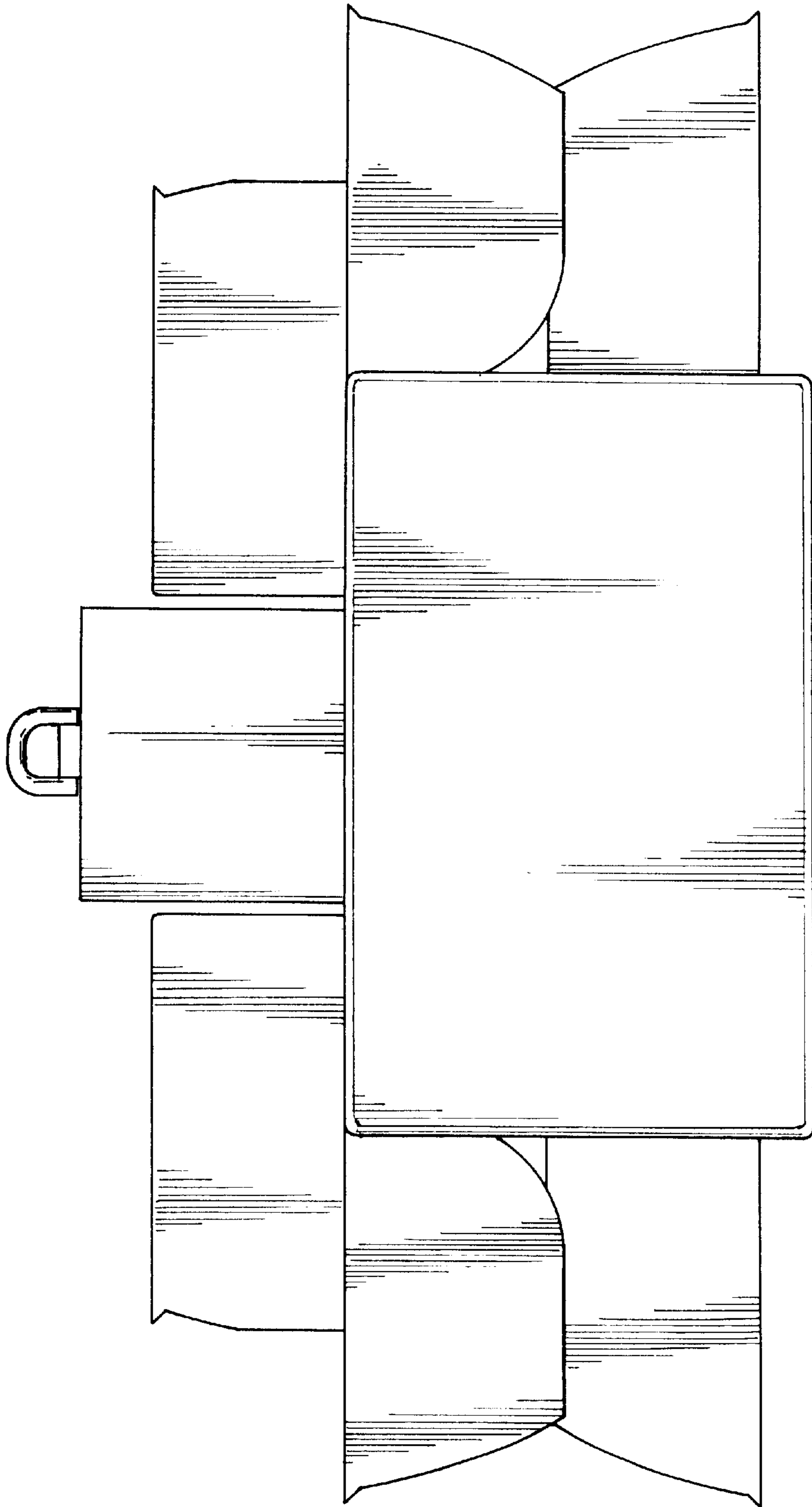

FIG. 7

FIG. 8

