



US00D474821S

(12) **United States Design Patent**
Wells et al.

(10) **Patent No.:** **US D474,821 S**

(45) **Date of Patent:** **** May 20, 2003**

(54) **GOLF PUTTER HEAD**

(75) Inventors: **James Wells**, Phoenix, AZ (US);
Michael R. Nicolette, Scottsdale, AZ
(US); **Bradley D. Schweigert**,
Glendale, AZ (US)

(73) Assignee: **Karsten Manufacturing Corporation**,
Phoenix, AZ (US)

(**) Term: **14 Years**

(21) Appl. No.: **29/158,644**

(22) Filed: **Apr. 5, 2002**

(51) **LOC (7) Cl.** **21-02**

(52) **U.S. Cl.** **D21/743**

(58) **Field of Search** D21/736-746;
473/324, 327, 328, 340, 341, 251-256

(56) **References Cited**

U.S. PATENT DOCUMENTS

D255,373 S	6/1980	Solheim	
D293,126 S	* 12/1987	Bizovi	D21/741
D379,484 S	5/1997	Solheim	
D380,029 S	6/1997	Anderson	
D396,082 S	* 7/1998	Sheets	D21/742
D398,352 S	* 9/1998	Sheets	D21/742
D399,911 S	10/1998	Nicolette	
D405,137 S	2/1999	Nelson	
D410,717 S	6/1999	Anderson	
D411,271 S	6/1999	Nelson	
D444,833 S	7/2001	Wells	
D449,865 S	10/2001	Fife, Jr.	
D451,973 S	12/2001	Wells	

* cited by examiner

Primary Examiner—Mitchell Siegel
(74) *Attorney, Agent, or Firm*—Darrell F. Marquette

(57) **CLAIM**

We claim the ornamental design for a golf putter head, as shown and described.

DESCRIPTION

FIG. 1 is perspective view of a golf putter head showing one embodiment of our new design;
 FIG. 2 is a rear elevational view of the golf putter head shown in FIG. 1;
 FIG. 3 is a front elevational view of the golf putter head shown in FIG. 1;
 FIG. 4 is an enlarged toe end view of the golf putter head shown in FIG. 1;
 FIG. 5 is an enlarged heel end view of a golf putter head shown in FIG. 1;
 FIG. 6 is a top plan view of the golf putter head shown in FIG. 1;
 FIG. 7 is a bottom view of the golf putter head shown in FIG. 1;
 FIG. 8 is perspective view of a golf putter head showing another embodiment of our new design;
 FIG. 9 is a rear elevational view of the golf putter head shown in FIG. 8;
 FIG. 10 is a front elevational view of the golf putter head shown in FIG. 8;
 FIG. 11 is an enlarged toe end view of the golf putter head shown in FIG. 8;
 FIG. 12 is an enlarged heel end view of a golf putter head shown in FIG. 8;
 FIG. 13 is a top plan view of the golf putter head shown in FIG. 8; and,
 FIG. 14 is a bottom view of the golf putter head shown in FIG. 8.

The shaft portions shown in FIGS. 1-14 are for illustrative purposes only and form no part of the claimed design.

1 Claim, 2 Drawing Sheets

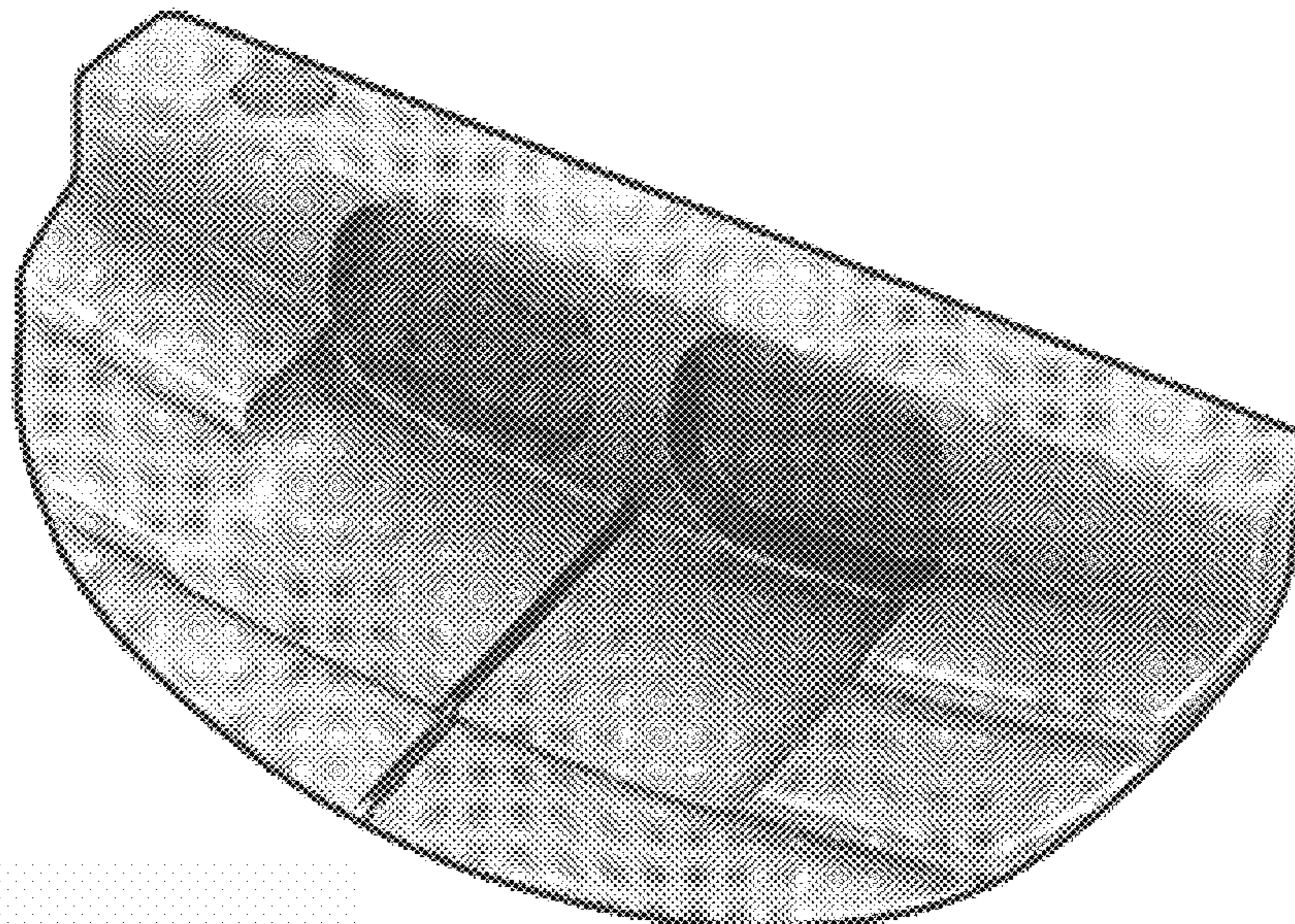

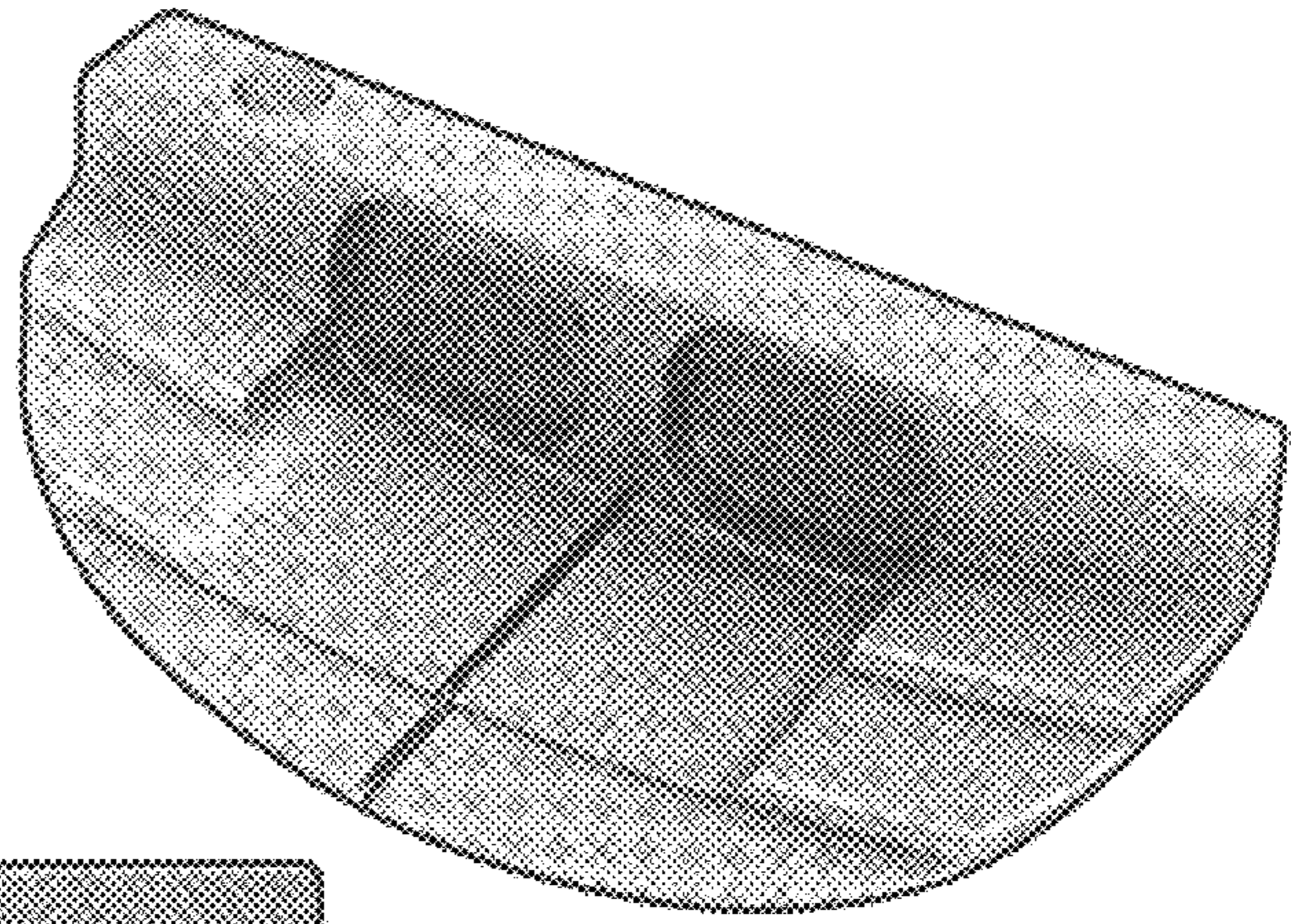

Fig.1

Fig.2

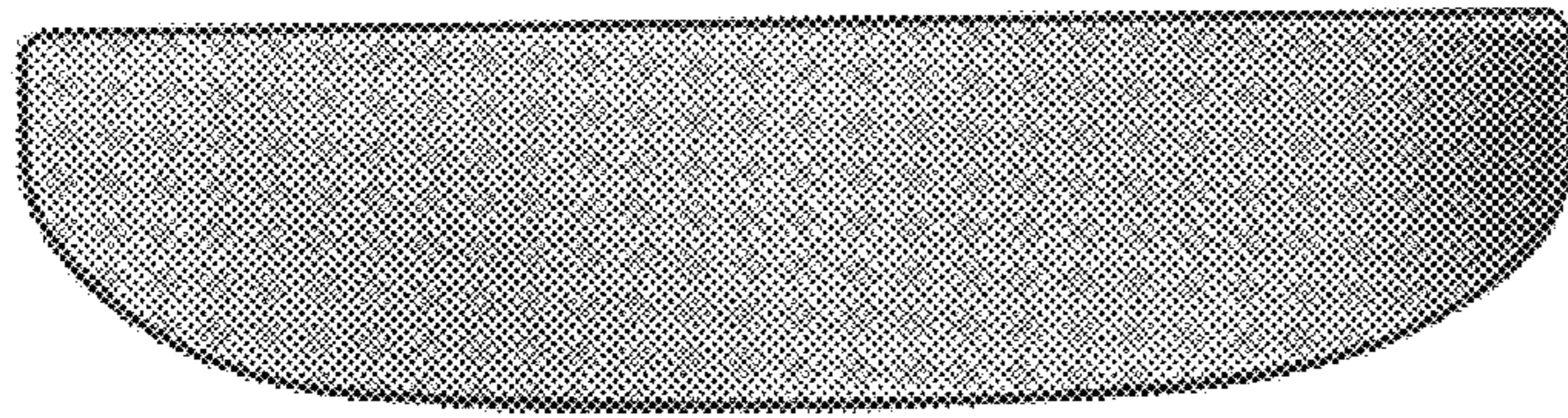
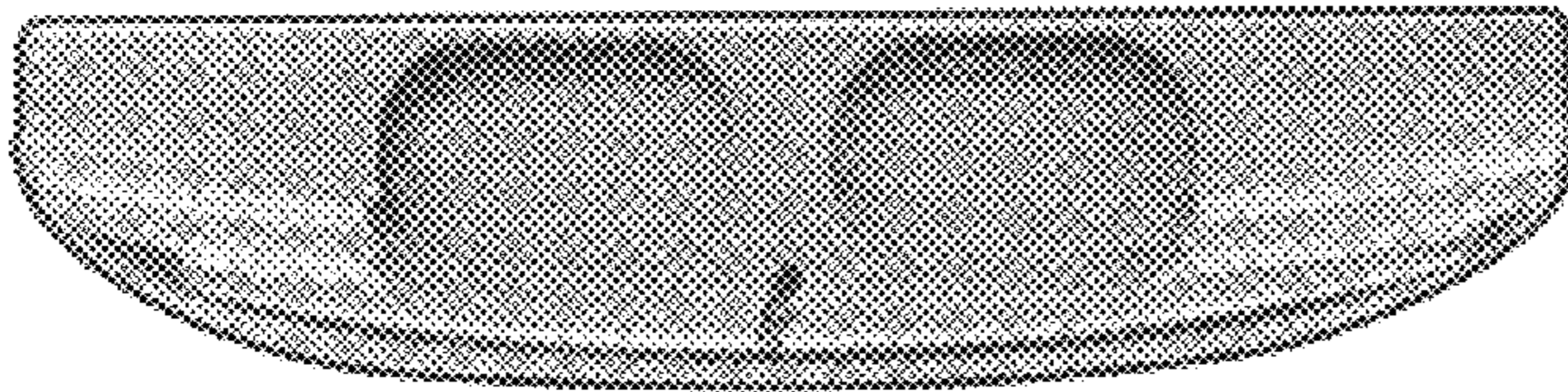

Fig.3

Fig.6

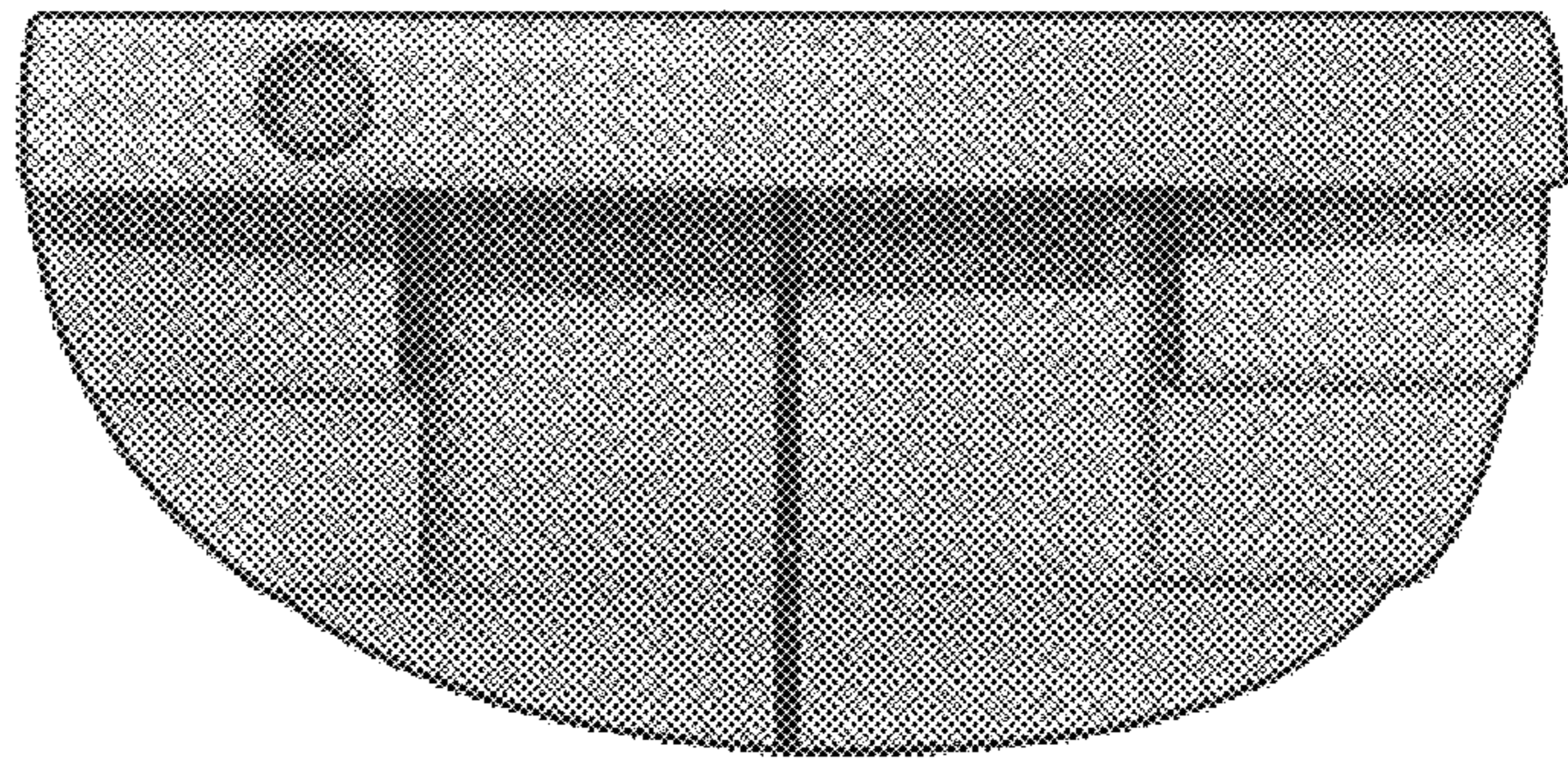

Fig.4

Fig.5

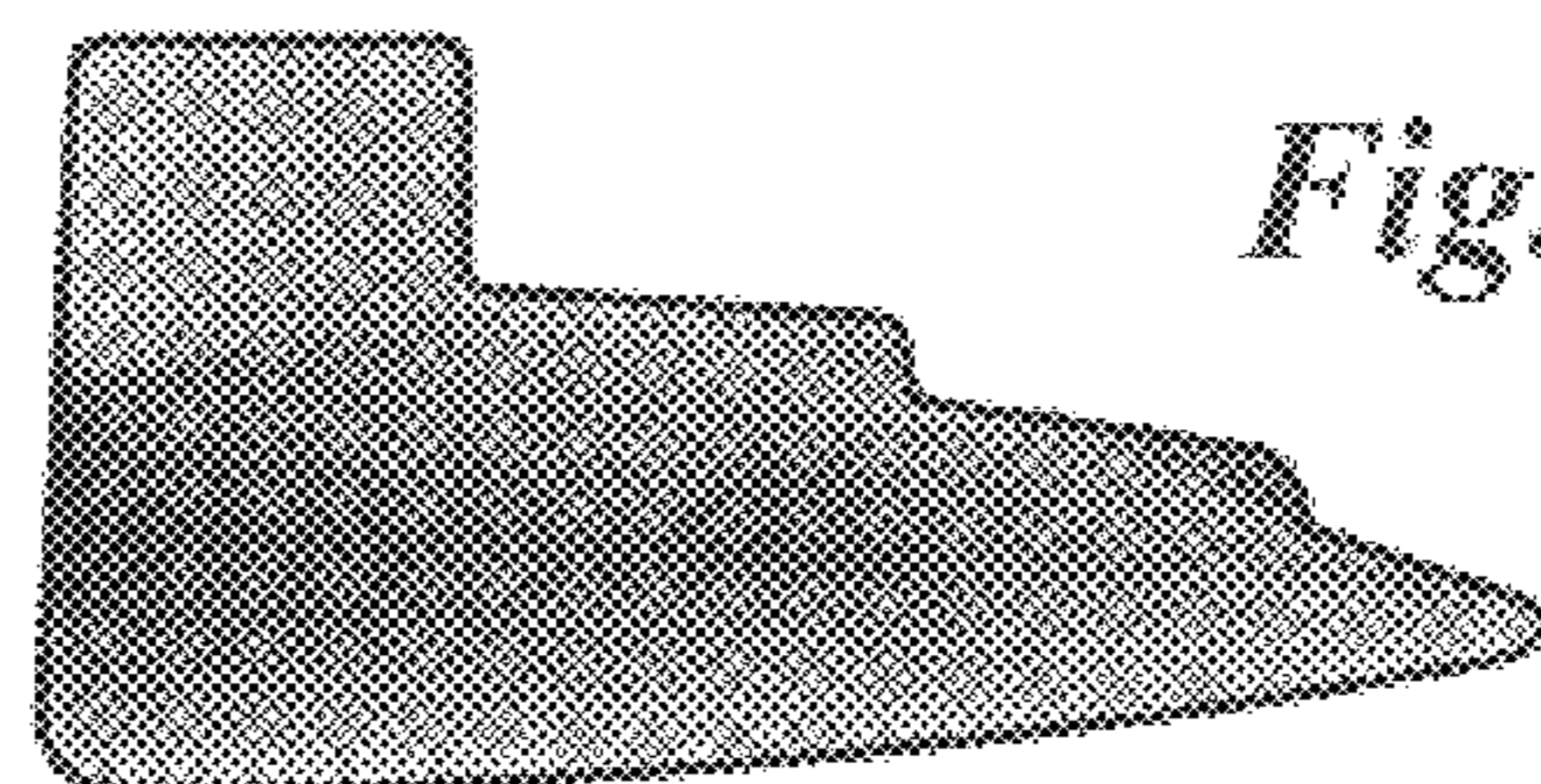
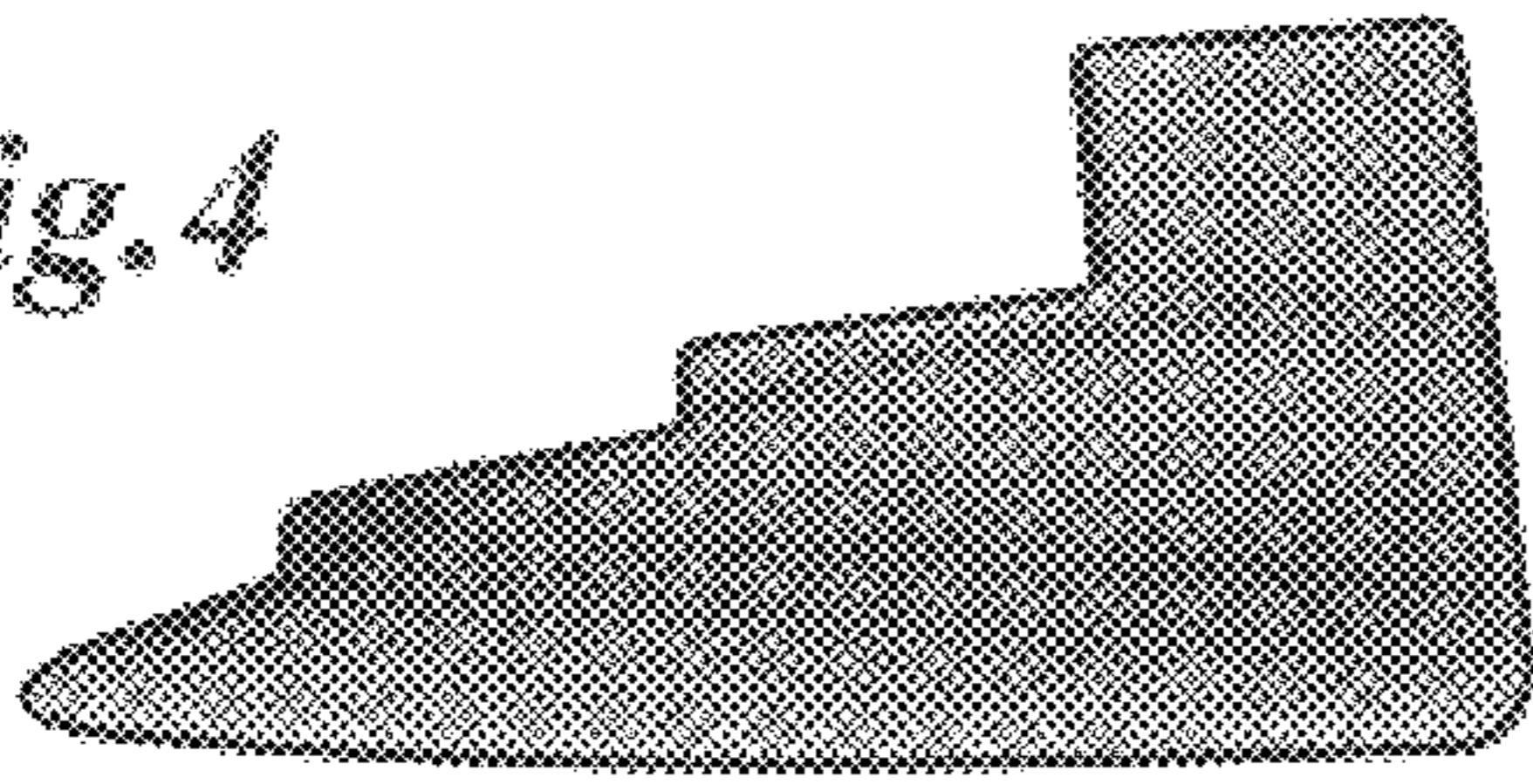
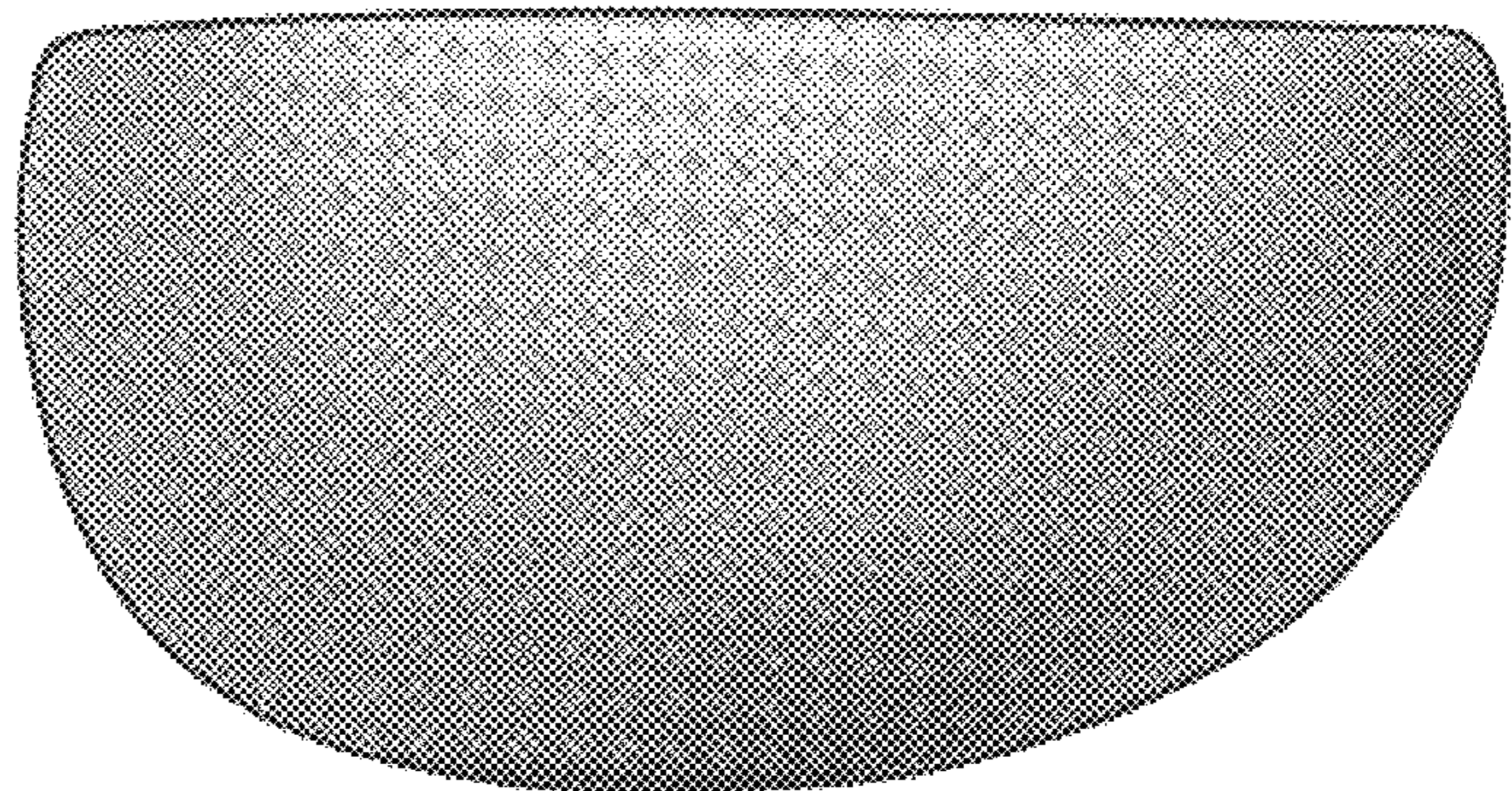

Fig.7



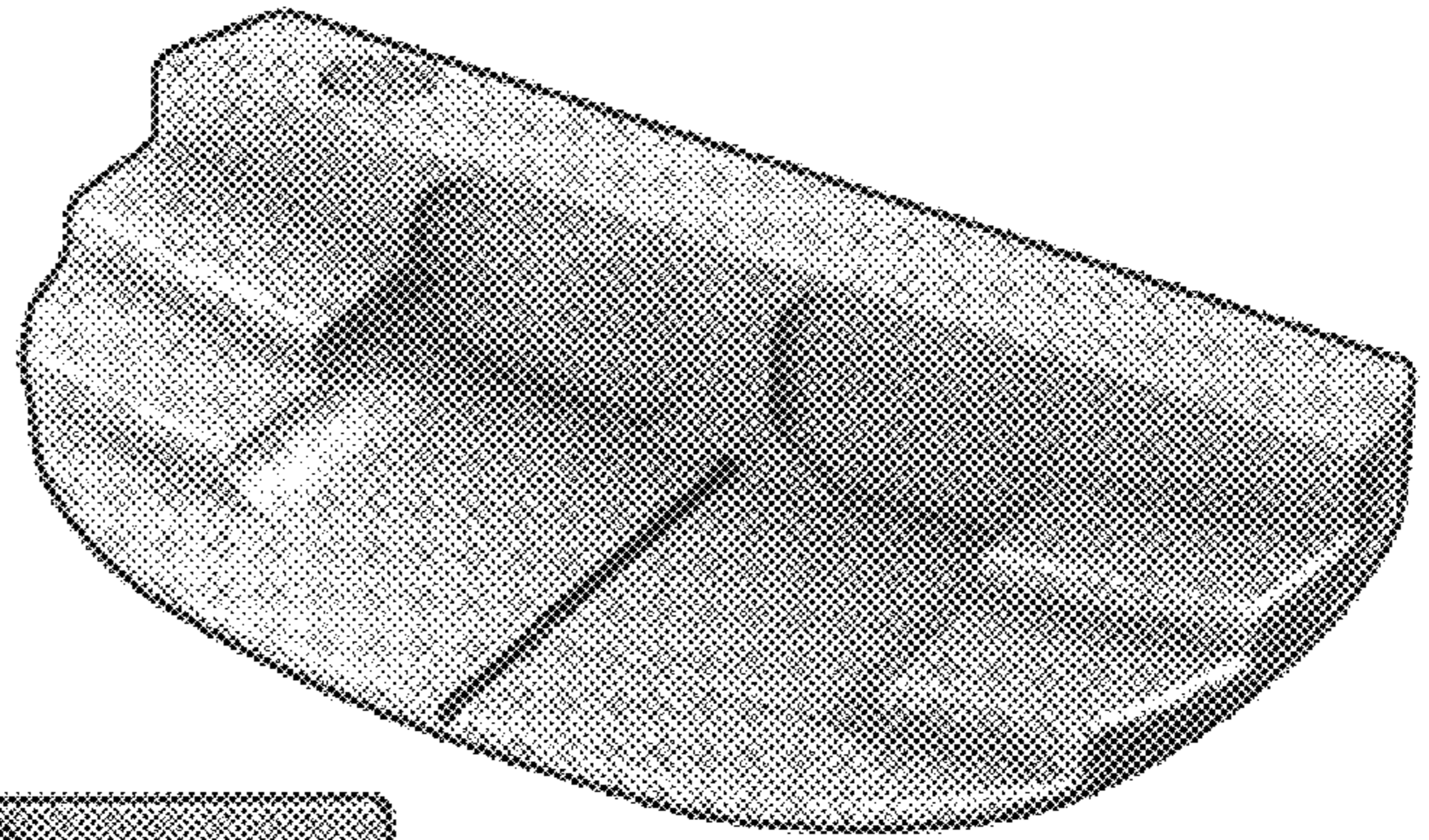

Fig. 8

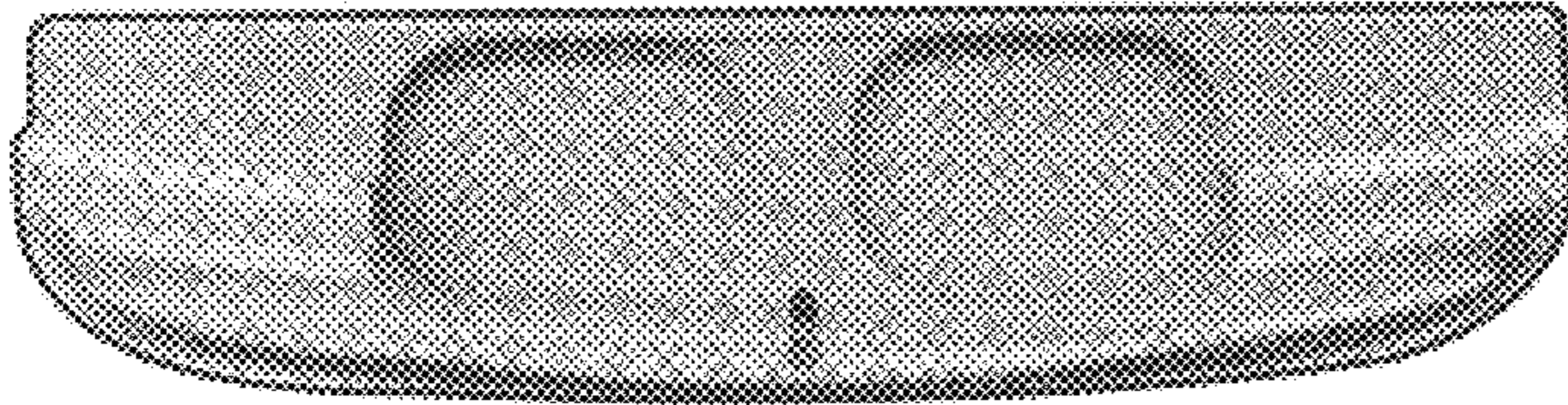

Fig. 9

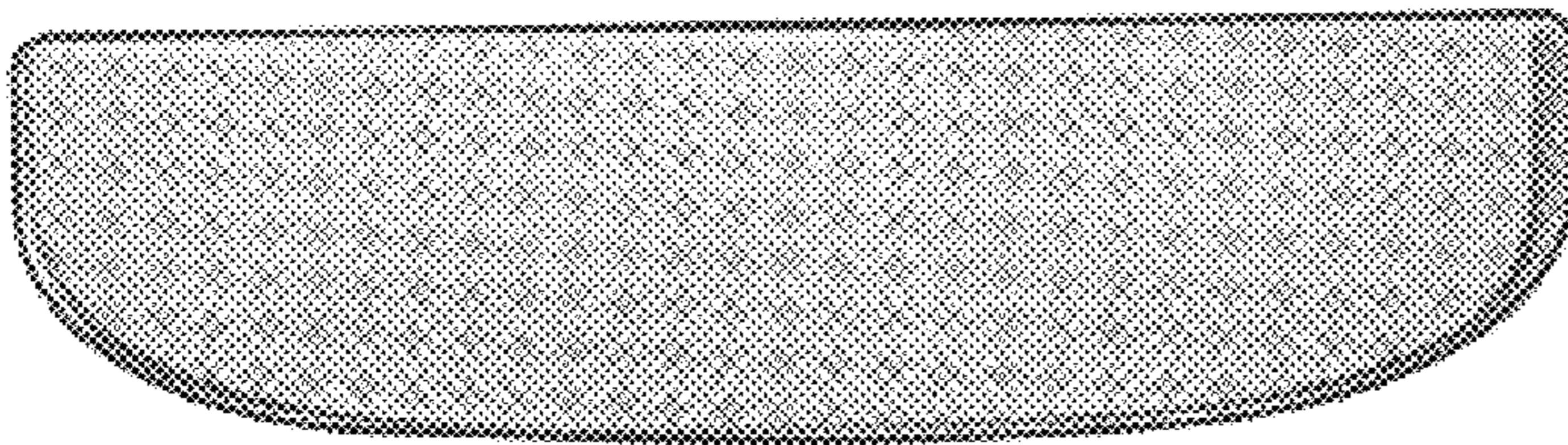

Fig. 10

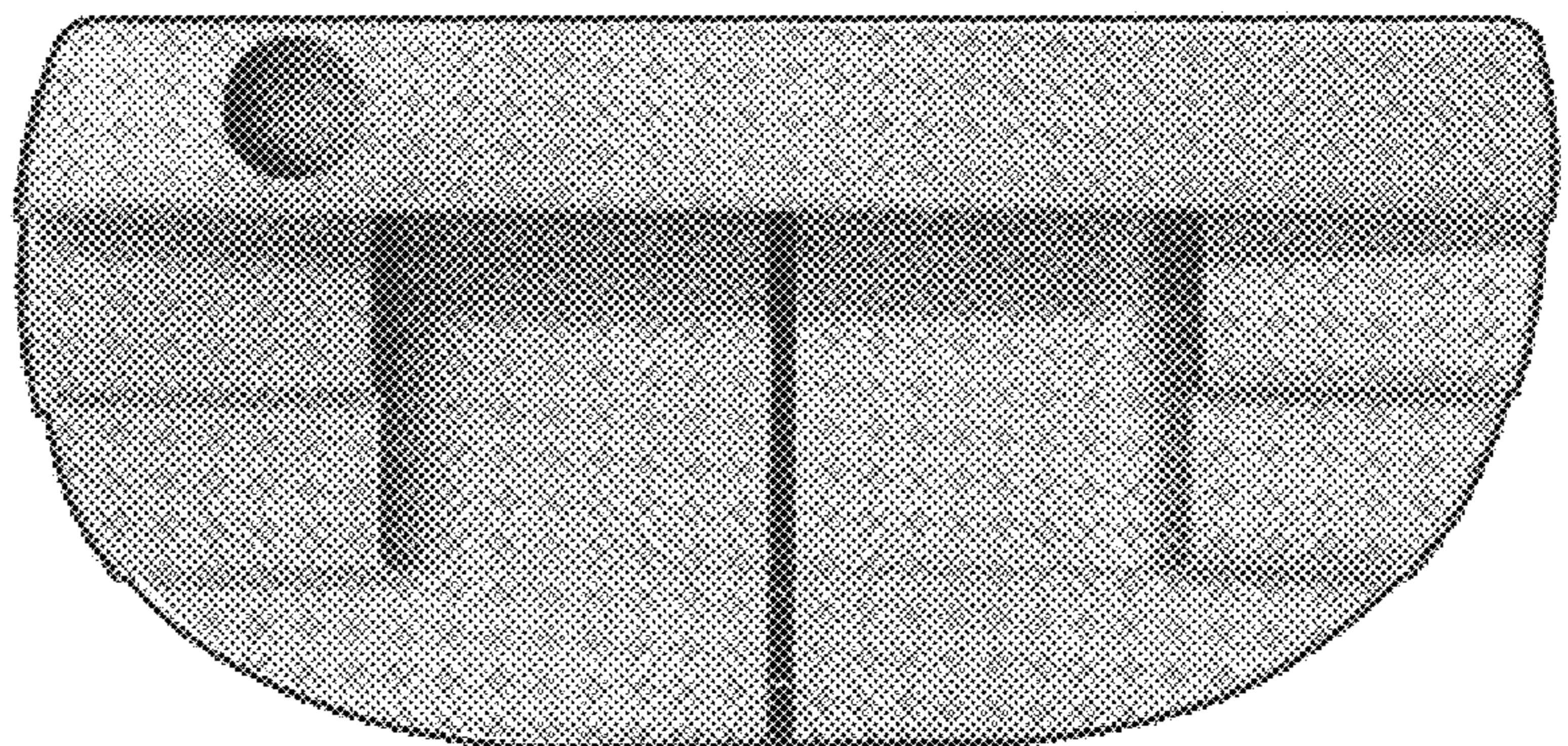

Fig. 11

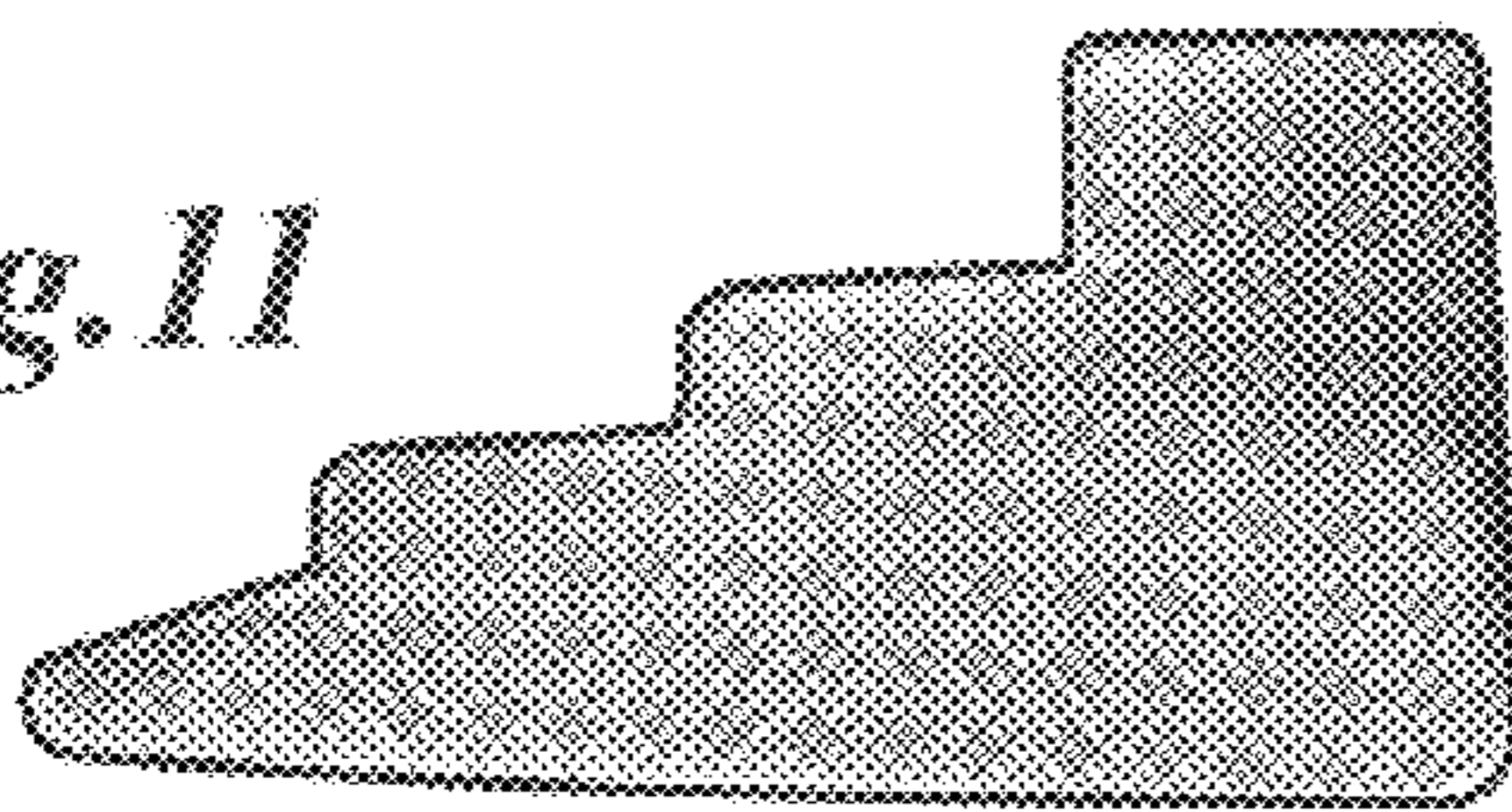

Fig. 12

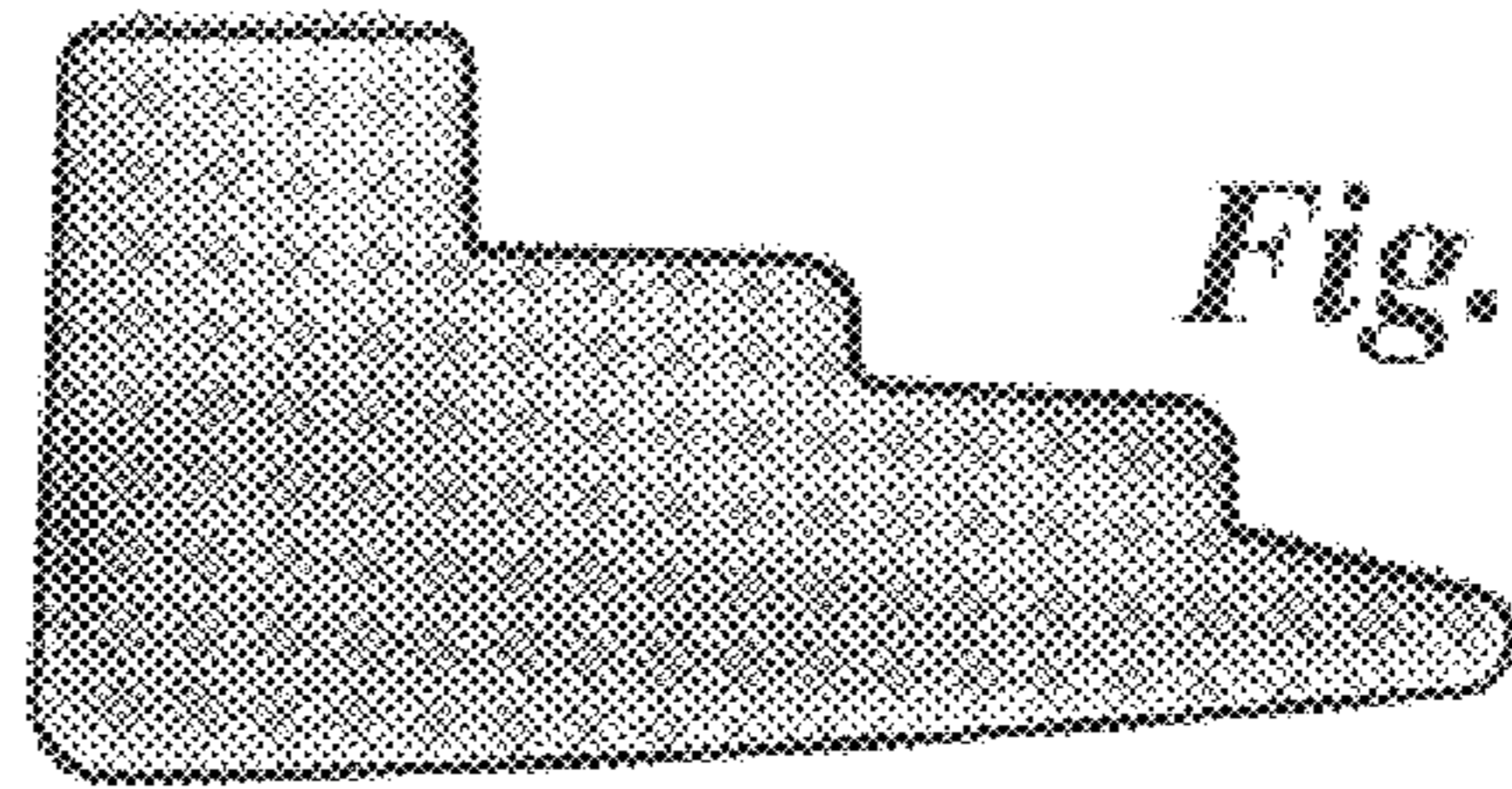

Fig. 13

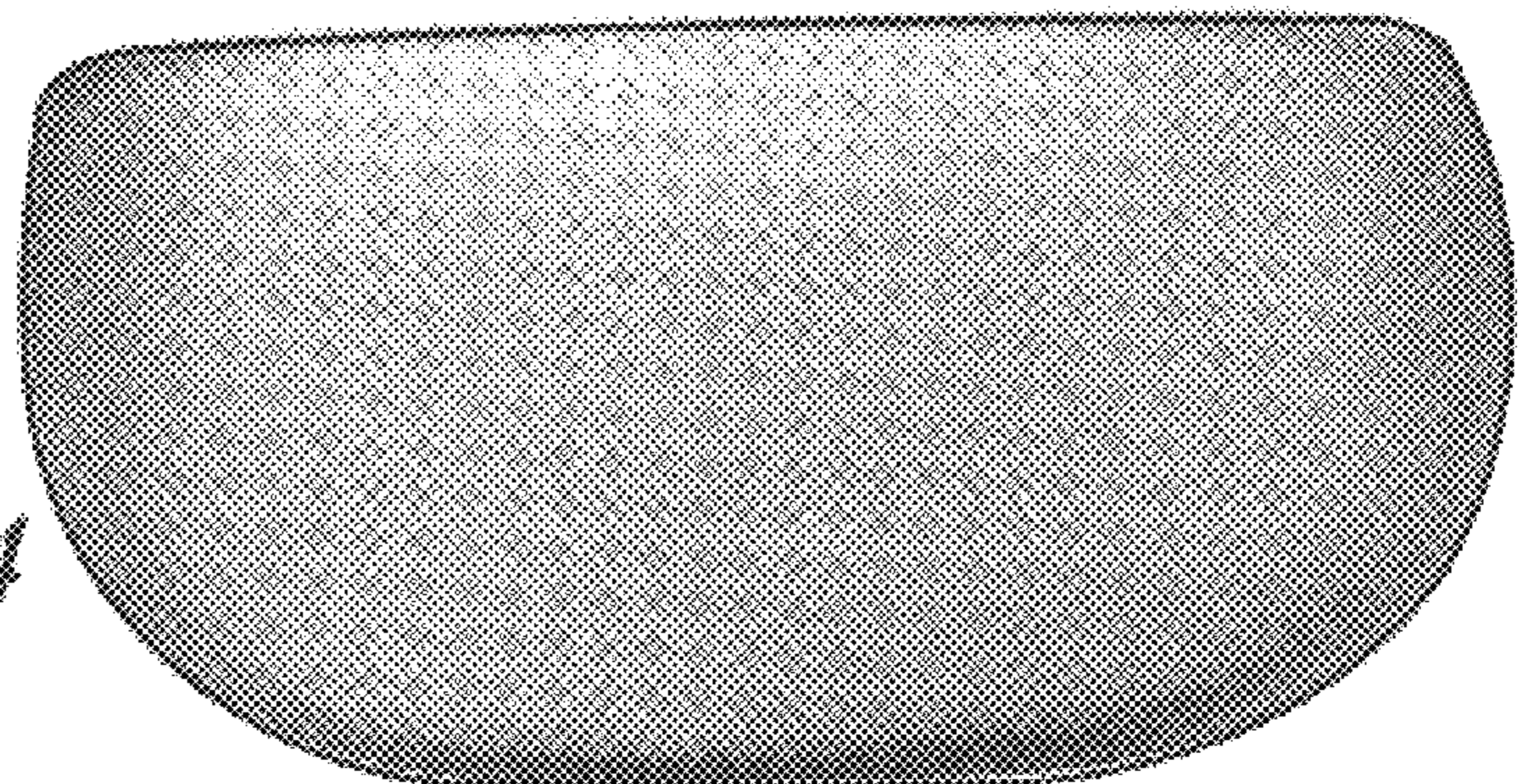

Fig. 14

UNITED STATES PATENT AND TRADEMARK OFFICE
CERTIFICATE OF CORRECTION

PATENT NO. : Des. 474,821 S
DATED : May 20, 2003
INVENTOR(S) : Wells et al.

Page 1 of 4

It is certified that error appears in the above-identified patent and that said Letters Patent is hereby corrected as shown below:

The title page showing the illustrative figure, should be deleted and replace with the attached title page.

Delete drawing sheets 1-2 and replace them with the drawings consisting of figures 1-14.

Signed and Sealed this

Seventh Day of October, 2003

A handwritten signature in black ink, appearing to read "James E. Rogan", written over a horizontal line.

JAMES E. ROGAN
Director of the United States Patent and Trademark Office

(12) **United States Design Patent** (10) **Patent No.:** **US D474,821 S**
Wells et al. (45) **Date of Patent:** **** May 20, 2003**

(54) **GOLF PUTTER HEAD**

(75) **Inventors:** James Wells, Phoenix, AZ (US);
 Michael R. Nicolette, Scottsdale, AZ
 (US); Bradley D. Schweigert,
 Glendale, AZ (US)

(73) **Assignee:** Karsten Manufacturing Corporation,
 Phoenix, AZ (US)

(**) **Term:** 14 Years

(21) **Appl. No.:** 29/158,644

(22) **Filed:** Apr. 5, 2002

(51) **LOC (7) Cl.** 21-02

(52) **U.S. Cl.** D21/743

(58) **Field of Search** D21/736-746;
 473/324, 327, 328, 340, 341, 251-256

(56) **References Cited**

U.S. PATENT DOCUMENTS

D255,373 S	6/1980	Solheim	
D293,126 S	* 12/1987	Bizovi	D21/741
D379,484 S	5/1997	Solheim	
D380,029 S	6/1997	Anderson	
D396,082 S	* 7/1998	Sheets	D21/742
D398,352 S	* 9/1998	Sheets	D21/742
D399,911 S	10/1998	Nicolette	
D405,137 S	2/1999	Nelson	
D410,717 S	6/1999	Anderson	
D411,271 S	6/1999	Nelson	
D444,833 S	7/2001	Wells	
D449,865 S	10/2001	Fife, Jr.	
D451,973 S	12/2001	Wells	

* cited by examiner

Primary Examiner—Mitchell Siegel

(74) *Attorney, Agent, or Firm*—Darrell F. Marquette

(57) **CLAIM**

We claim the ornamental design for a golf putter head, as shown and described.

DESCRIPTION

FIG. 1 is perspective view of a golf putter head showing one embodiment of our new design;
 FIG. 2 is a rear elevational view of the golf putter head shown in FIG. 1;
 FIG. 3 is a front elevational view of the golf putter head shown in FIG. 1;
 FIG. 4 is an enlarged toe end view of the golf putter head shown in FIG. 1;
 FIG. 5 is an enlarged heel end view of a golf putter head shown in FIG. 1;
 FIG. 6 is a top plan view of the golf putter head shown in FIG. 1;
 FIG. 7 is a bottom view of the golf putter head shown in FIG. 1;
 FIG. 8 is perspective view of a golf putter head showing another embodiment of our new design;
 FIG. 9 is a rear elevational view of the golf putter head shown in FIG. 8;
 FIG. 10 is a front elevational view of the golf putter head shown in FIG. 8;
 FIG. 11 is an enlarged toe end view of the golf putter head shown in FIG. 8;
 FIG. 12 is an enlarged heel end view of a golf putter head shown in FIG. 8;
 FIG. 13 is a top plan view of the golf putter head shown in FIG. 8; and,
 FIG. 14 is a bottom view of the golf putter head shown in FIG. 8.
 The shaft portions shown in FIGS. 1-14 are for illustrative purposes only and form no part of the claimed design.

1 Claim, 2 Drawing Sheets

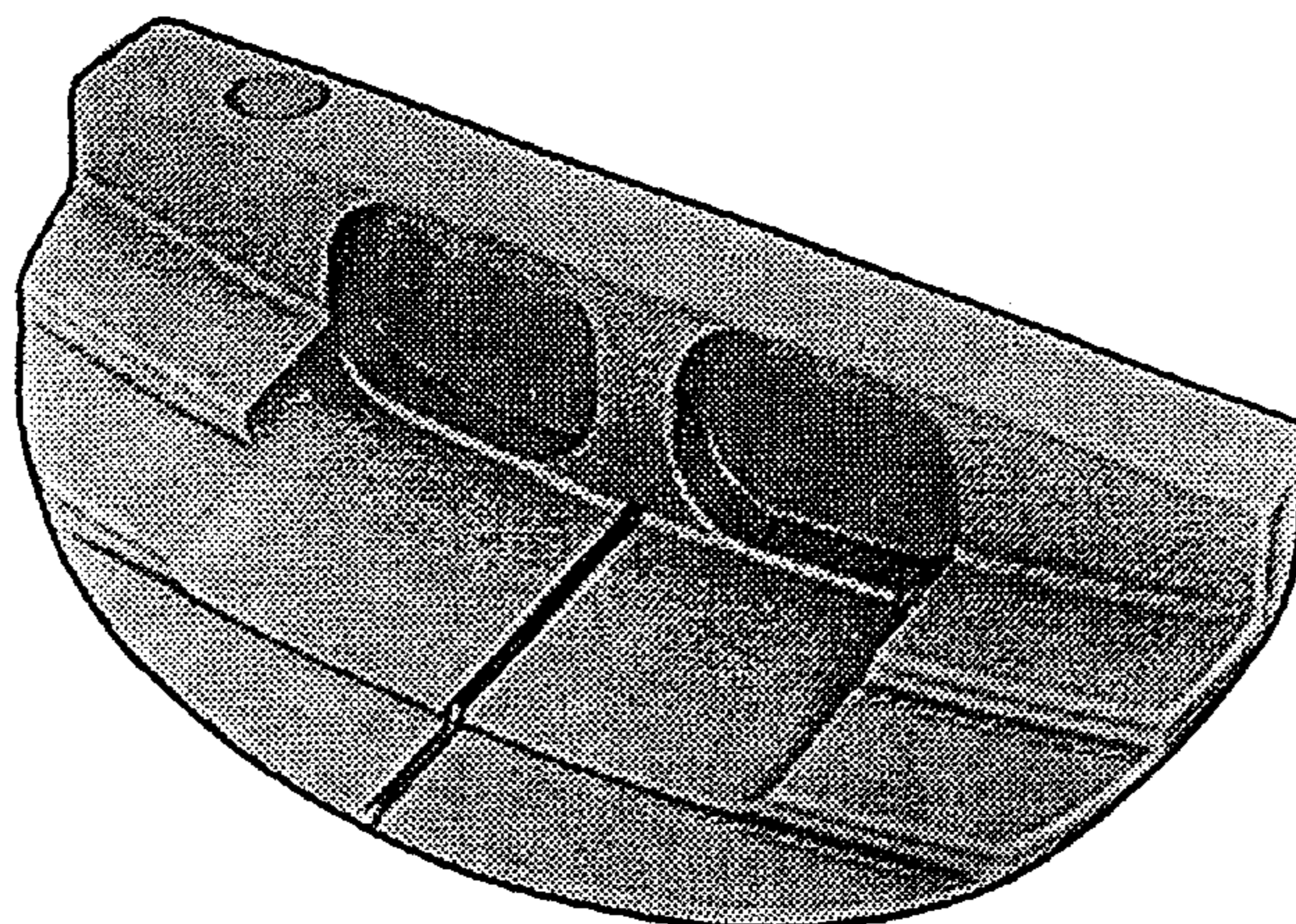

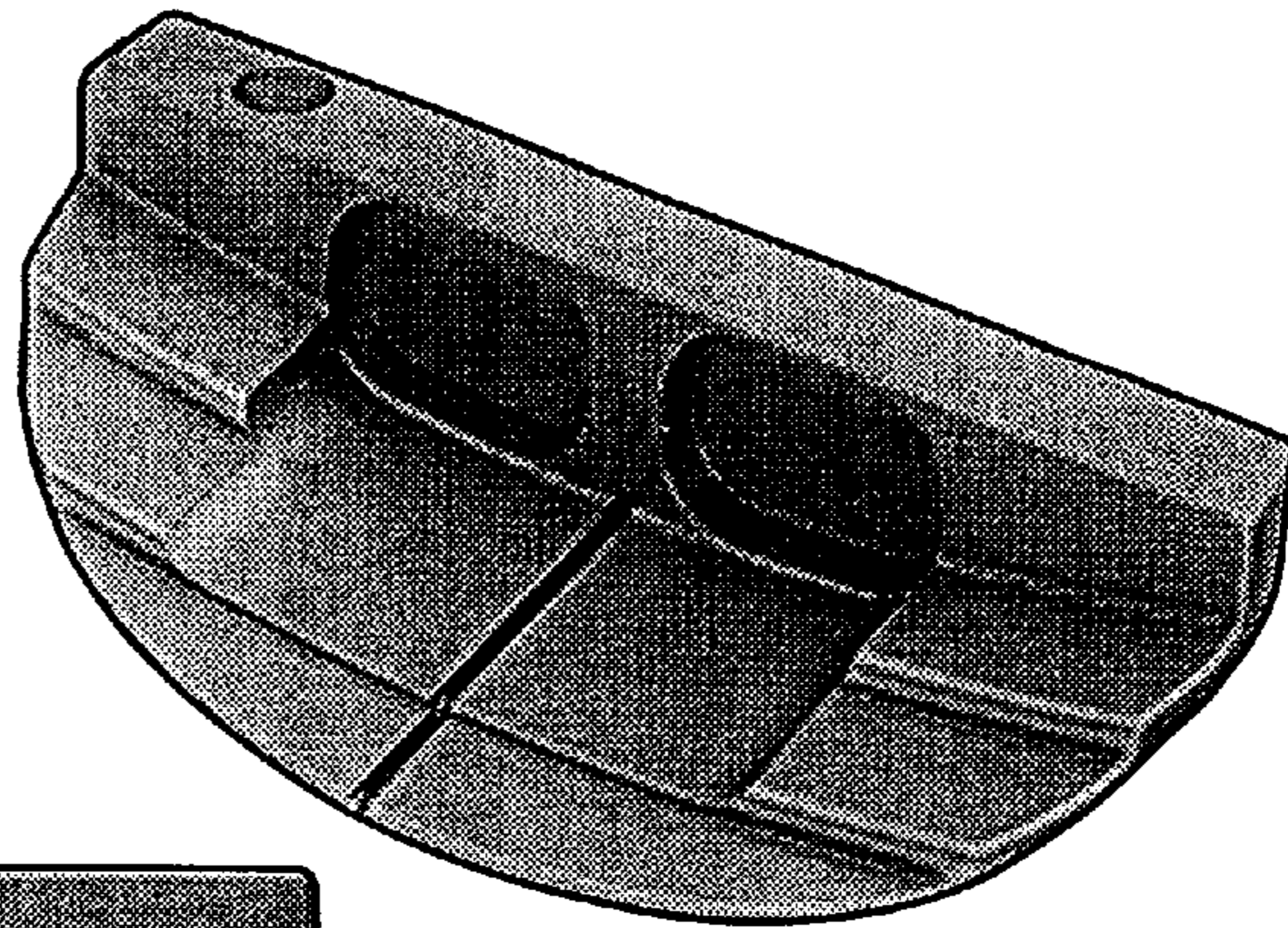

Fig.1

Fig.2

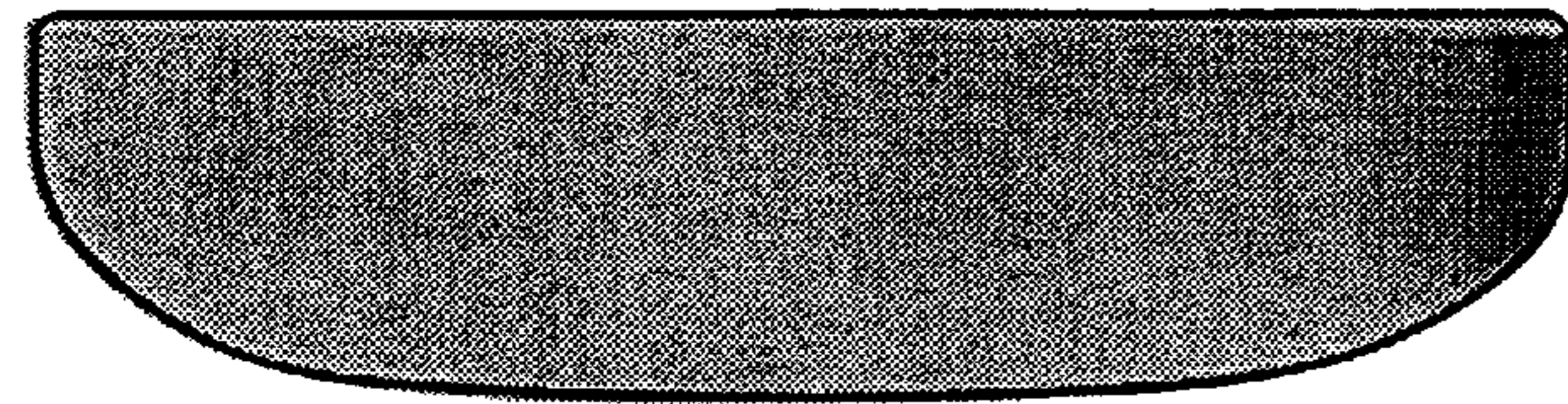
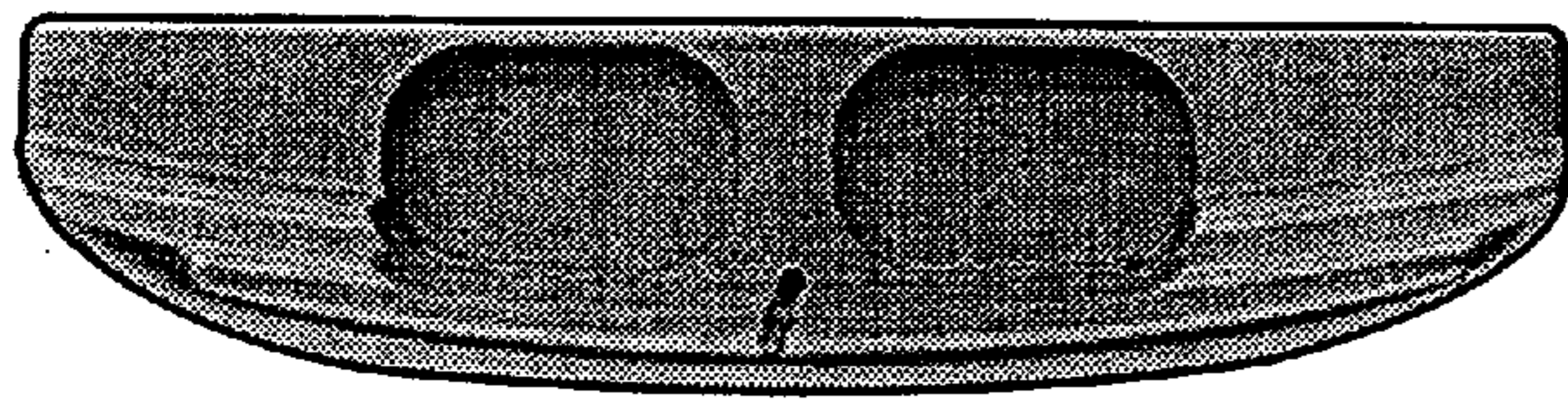

Fig.3

Fig.6

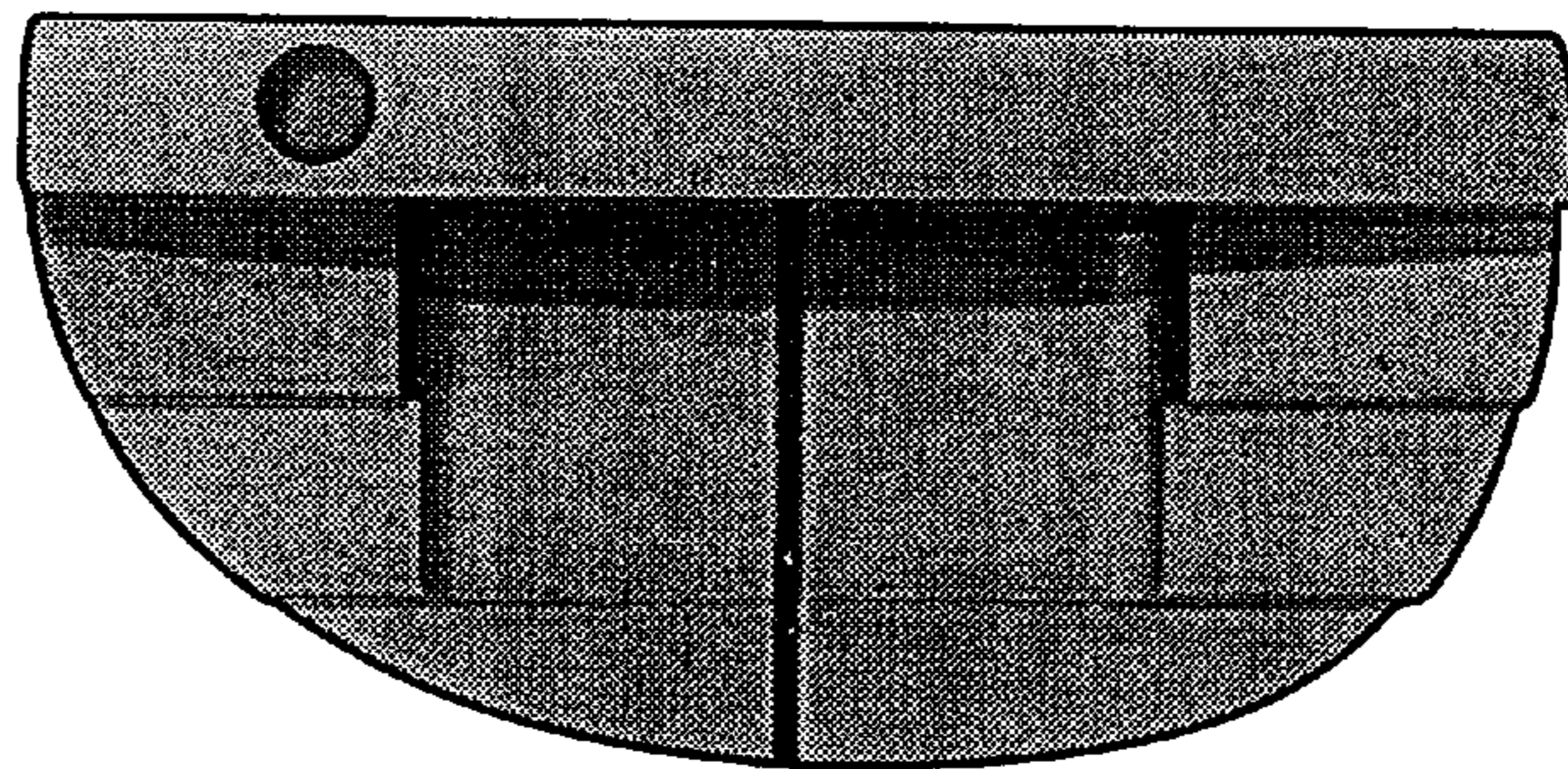

Fig.4

Fig.5

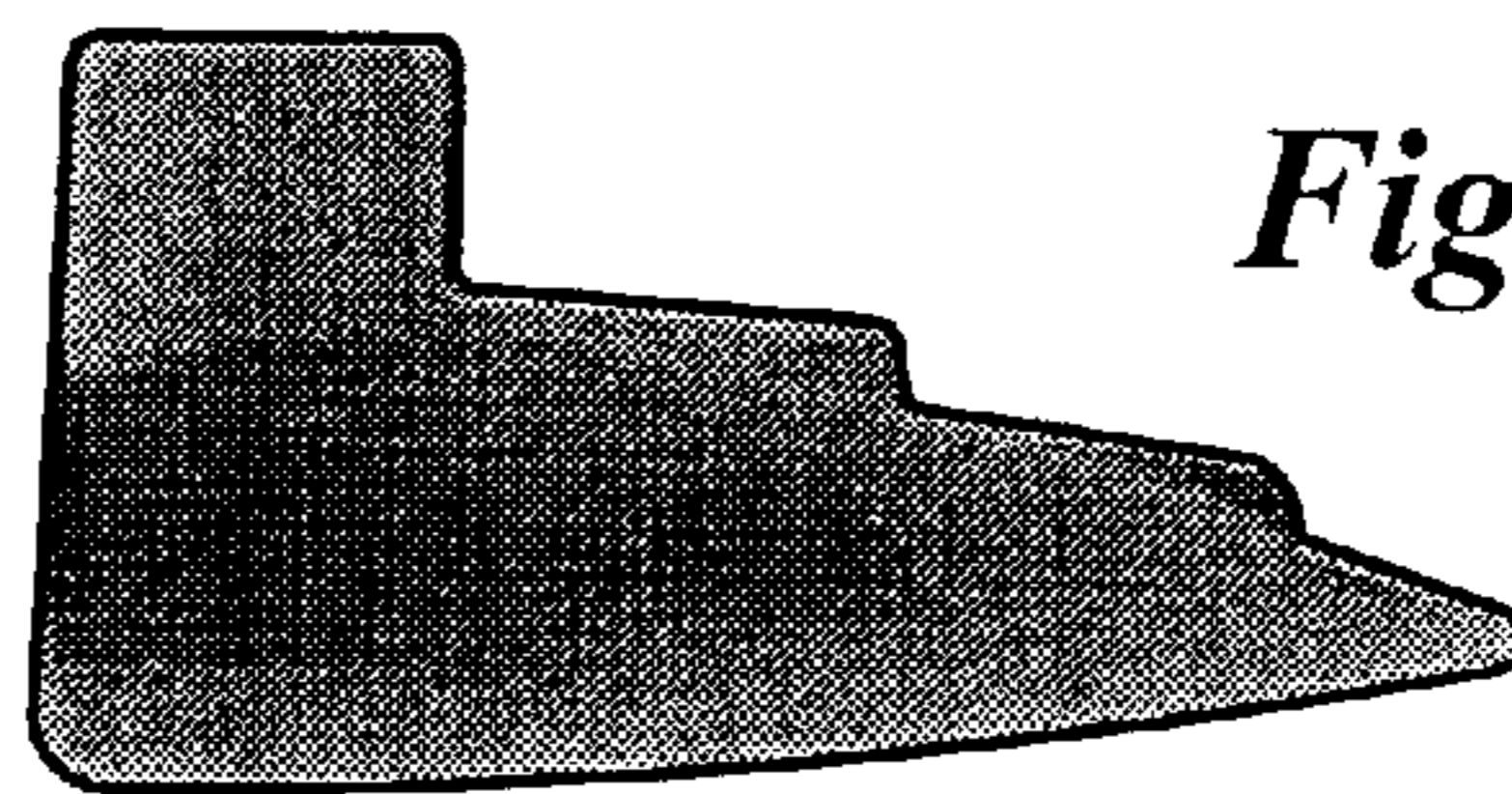
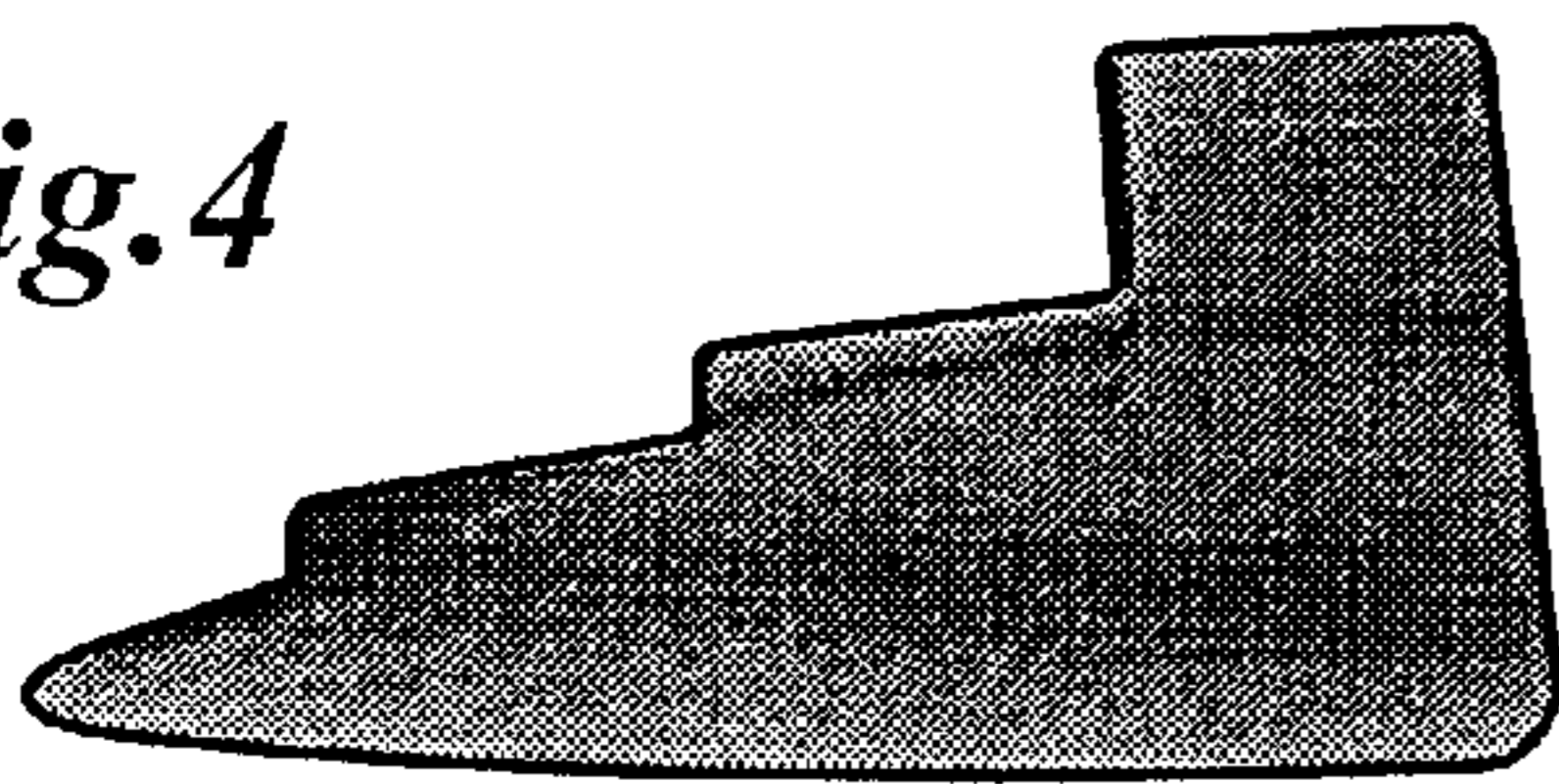
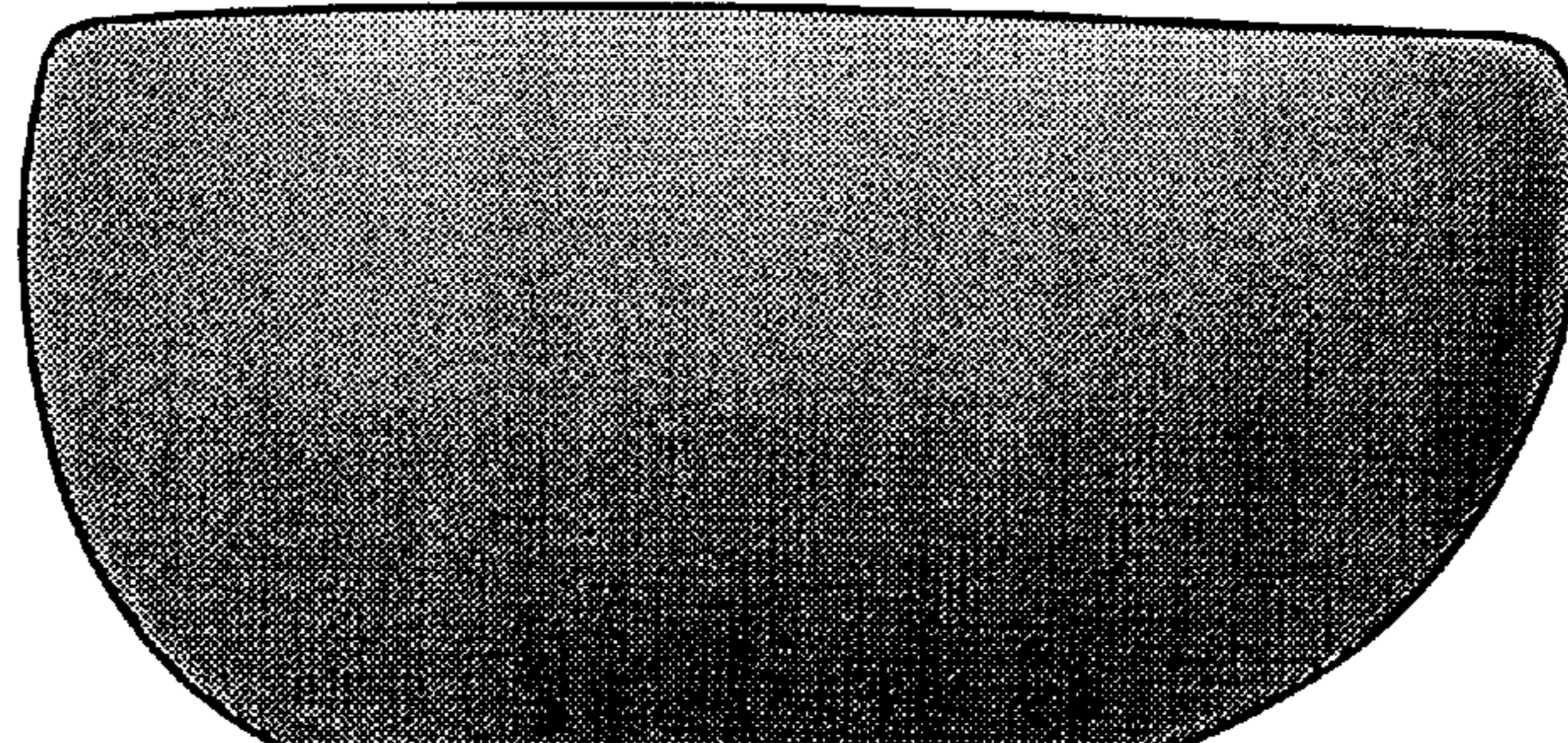

Fig.7



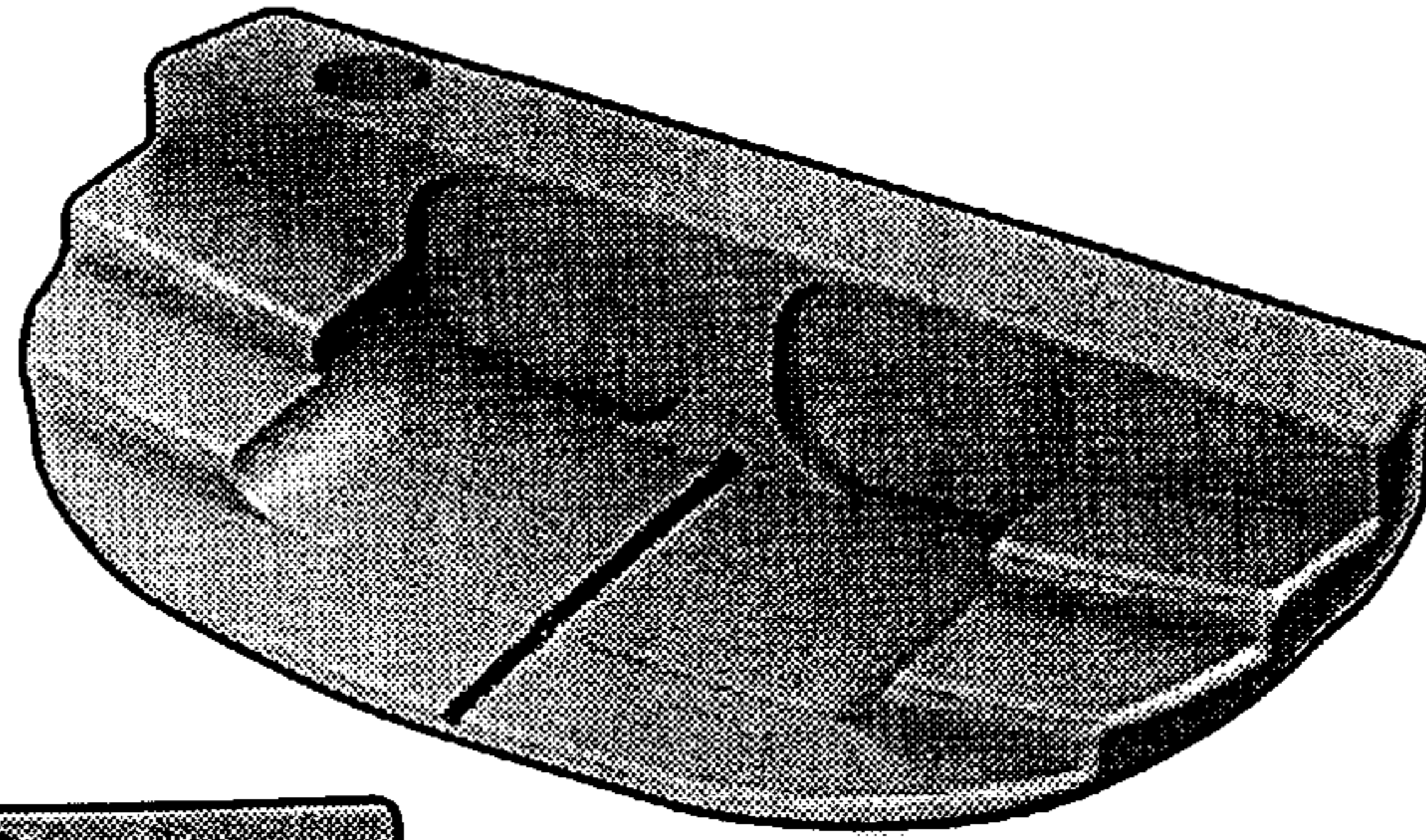

Fig. 8

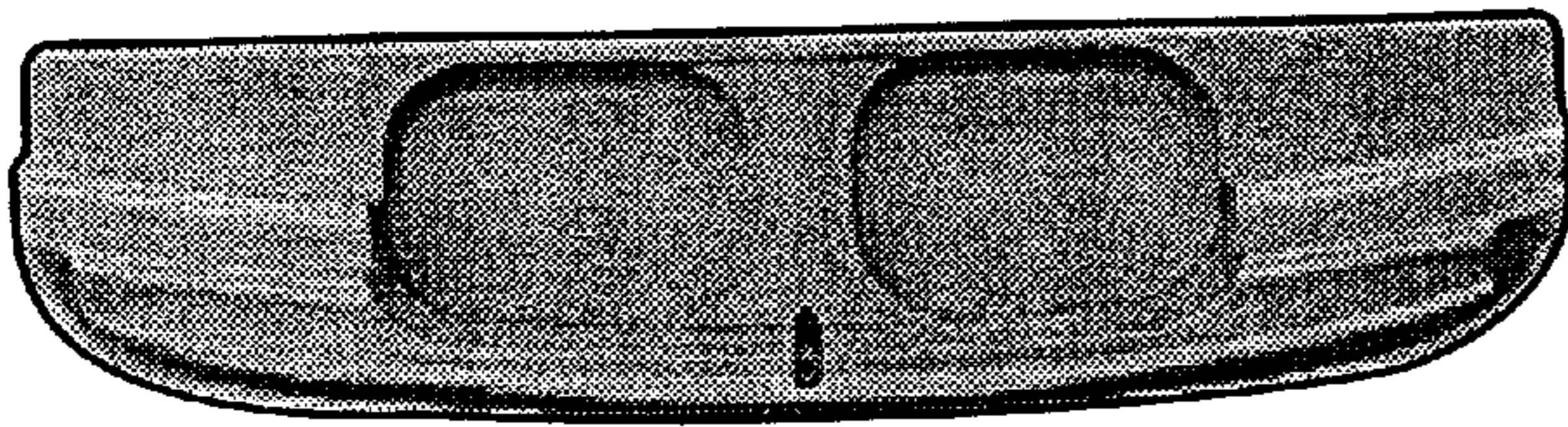

Fig. 9

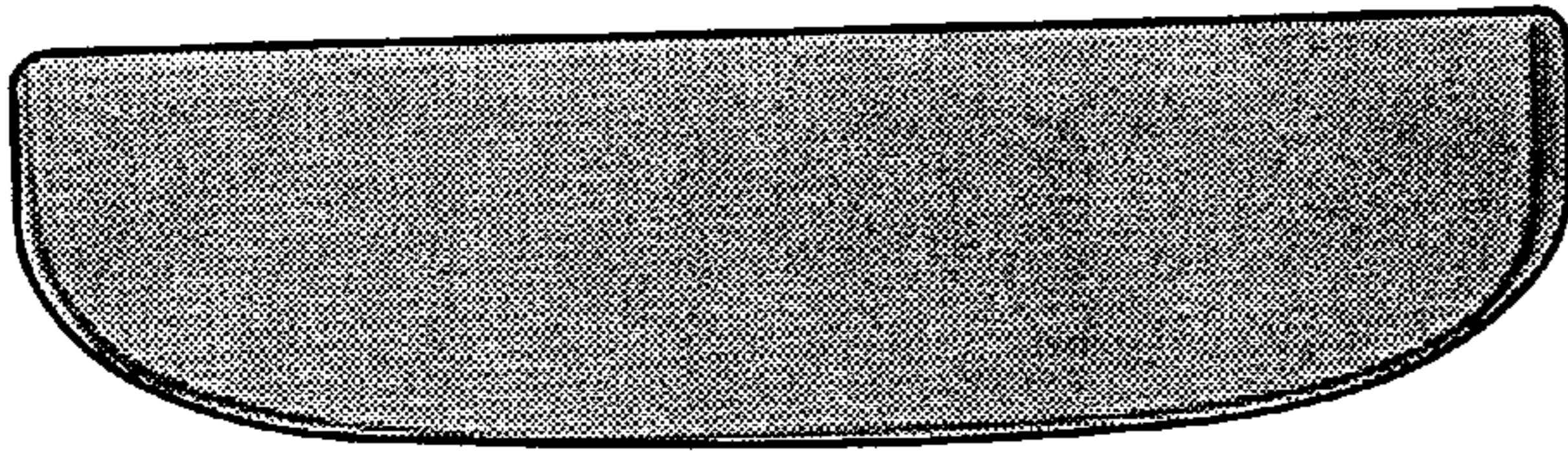

Fig. 10

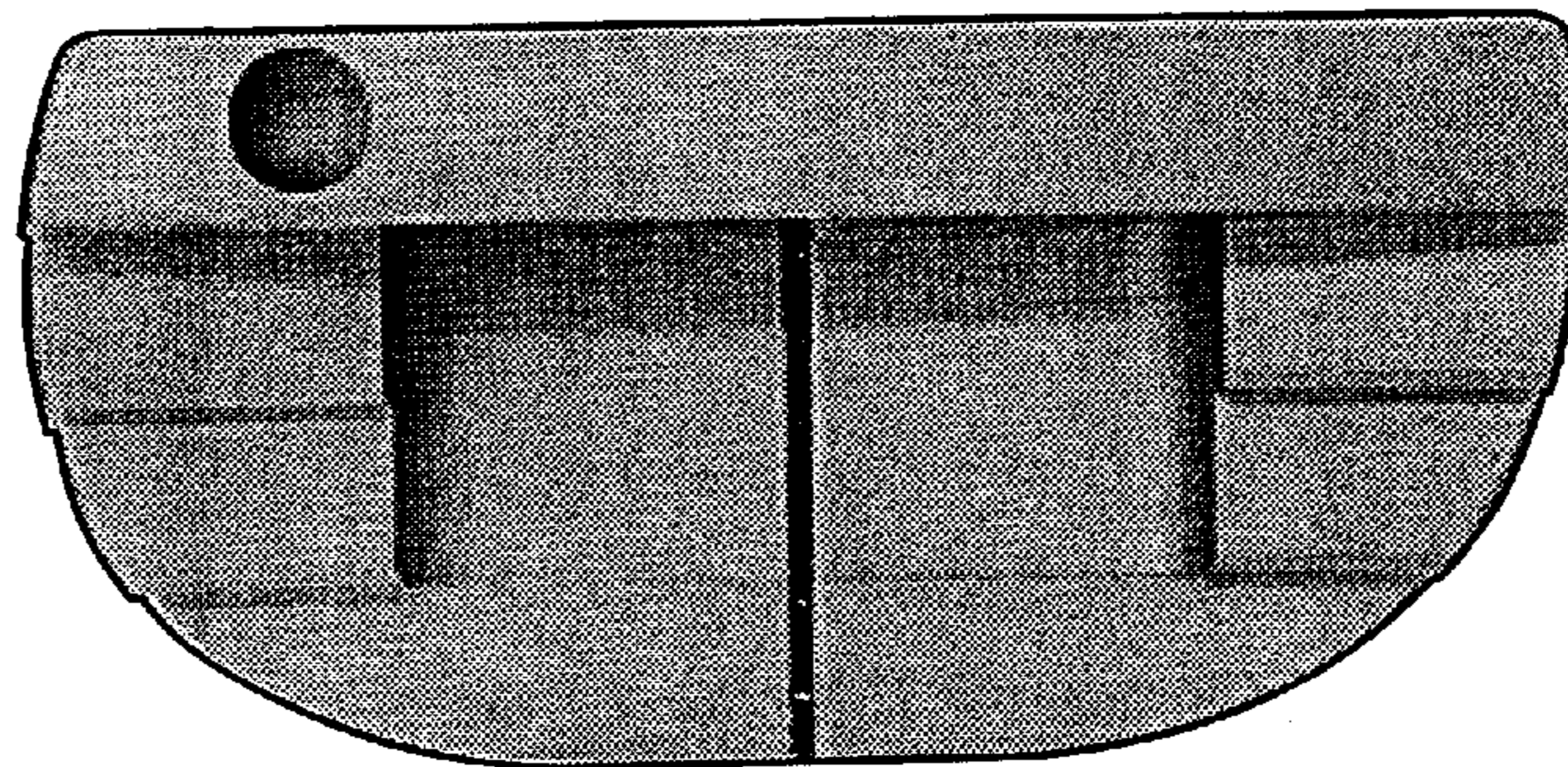

Fig. 11

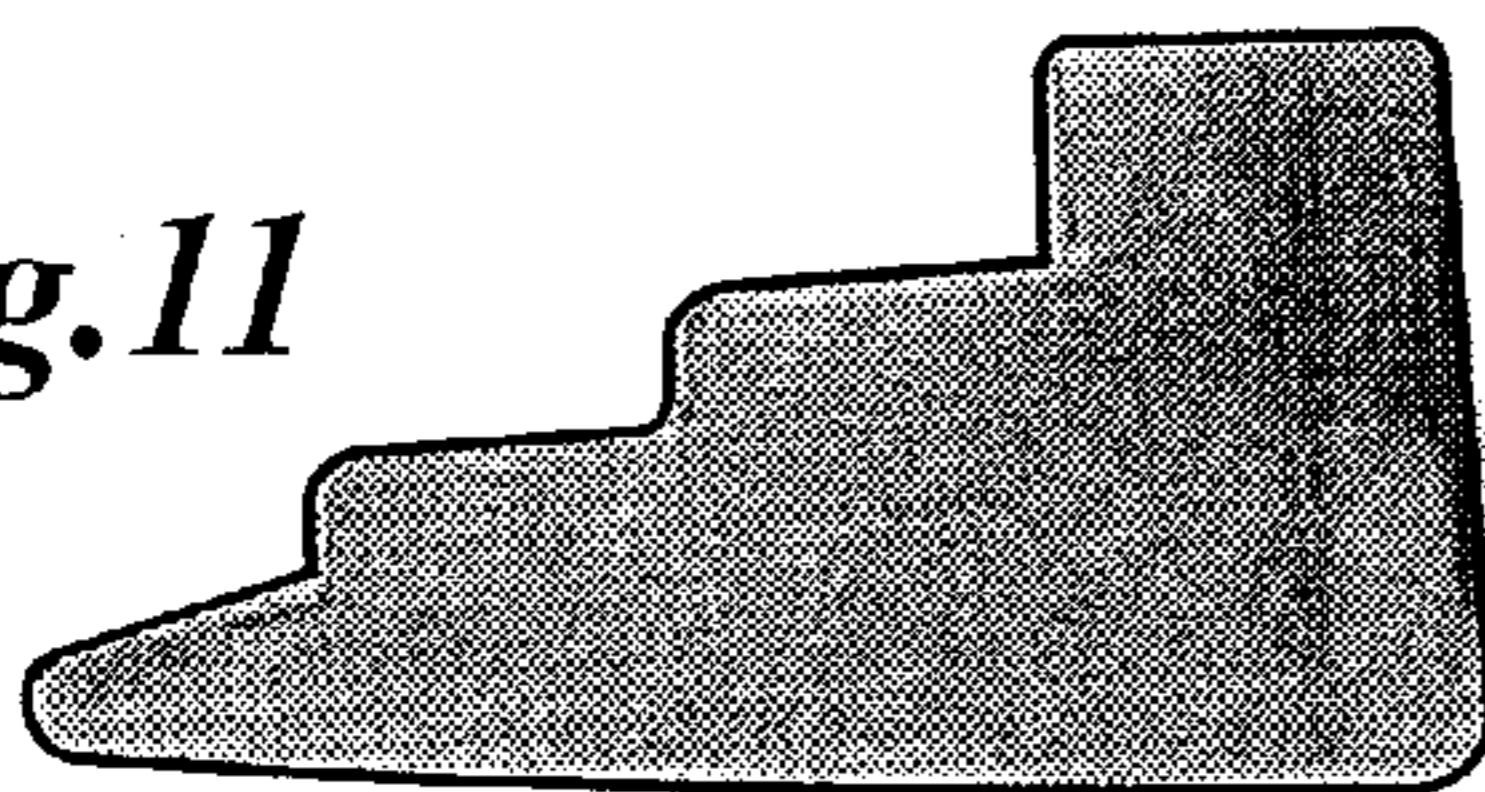

Fig. 12

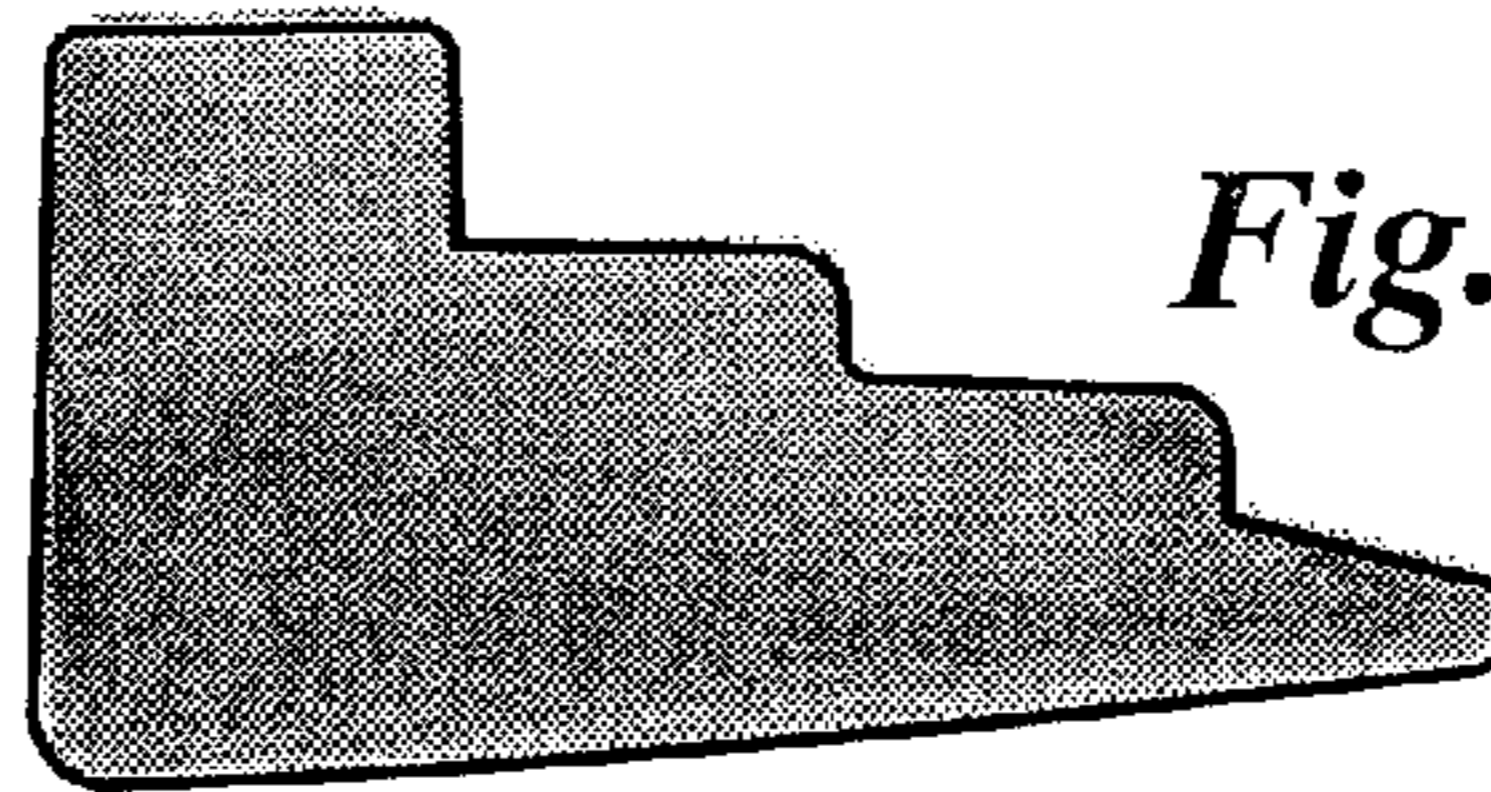

Fig. 13

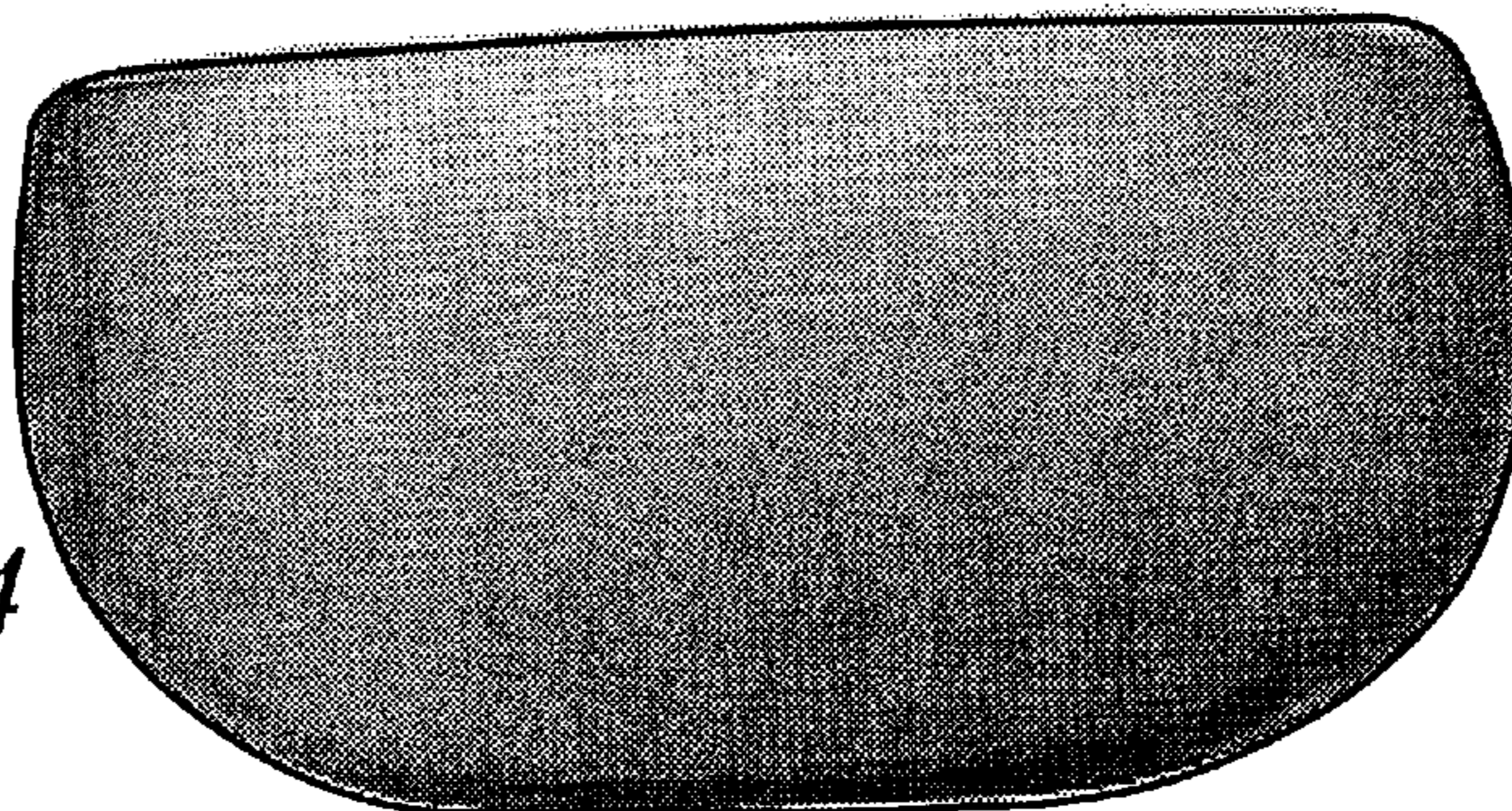

Fig. 14