



US00D474813S

(12) **United States Design Patent**  
**Wilson**

(10) **Patent No.:** **US D474,813 S**

(45) **Date of Patent:** **\*\* May 20, 2003**

(54) **GAME**

(76) **Inventor:** **Stephen Brian Wilson**, P.O. Box 646,  
Zionsville, IN (US) 46077

(\*\*) **Term:** **14 Years**

(21) **Appl. No.:** **29/147,064**

(22) **Filed:** **Aug. 22, 2001**

(51) **LOC (7) Cl.** ..... **21-01**

(52) **U.S. Cl.** ..... **D21/302**

(58) **Field of Search** ..... D21/312, 319,  
D21/385, 386, 789-792; 273/108.2, 108.21,  
108, 245, 148 R, 459

(56) **References Cited**

**U.S. PATENT DOCUMENTS**

D141,390 S	*	5/1945	Welsh	.....	D21/790
2,785,899 A	*	3/1957	Burke	.....	D21/319 X
2,908,503 A	*	10/1959	Austin et al.	.....	D21/790 X
D316,120 S	*	4/1991	Morris et al.	.....	D21/790
D350,989 S	*	9/1994	Lanier	.....	D21/319
5,522,629 A	*	6/1996	Loo	.....	294/58
D371,412 S	*	7/1996	Howard	.....	D21/791
D400,631 S	*	11/1998	Moore	.....	D21/319 X
5,860,648 A	*	1/1999	Petermeier et al.	.....	273/108.2

\* cited by examiner

*Primary Examiner*—Prabhakar Deshmukh

(74) *Attorney, Agent, or Firm*—Krieg DeVault Lundy, LLP

(57) **CLAIM**

The ornamental design for a game, as shown and described.

**DESCRIPTION**

FIG. 1 is a perspective view of a goal of a game showing my new design;

FIG. 2 is a perspective view of a club of the game in which elongated handle is generally perpendicular to the flat base portion of the club;

FIG. 3 is a fragmentary front elevational view of FIG. 1;

FIG. 4 is a fragmentary front elevational view of another version of the club of the game in which the elongated handle is mounted angularly with flat base portion of the club;

FIG. 5 is a fragmentary rear view of FIG. 1;

FIG. 6 is a fragmentary rear elevational view of the club of FIG. 4;

FIG. 7 is a fragmentary right side elevational view of FIG. 1, the left side elevational view being a mirror image thereof; and,

FIG. 8 is a fragmentary right side elevational view of FIGS. 2 and 4, the left side elevational view being a mirror image thereof.

**1 Claim, 2 Drawing Sheets**

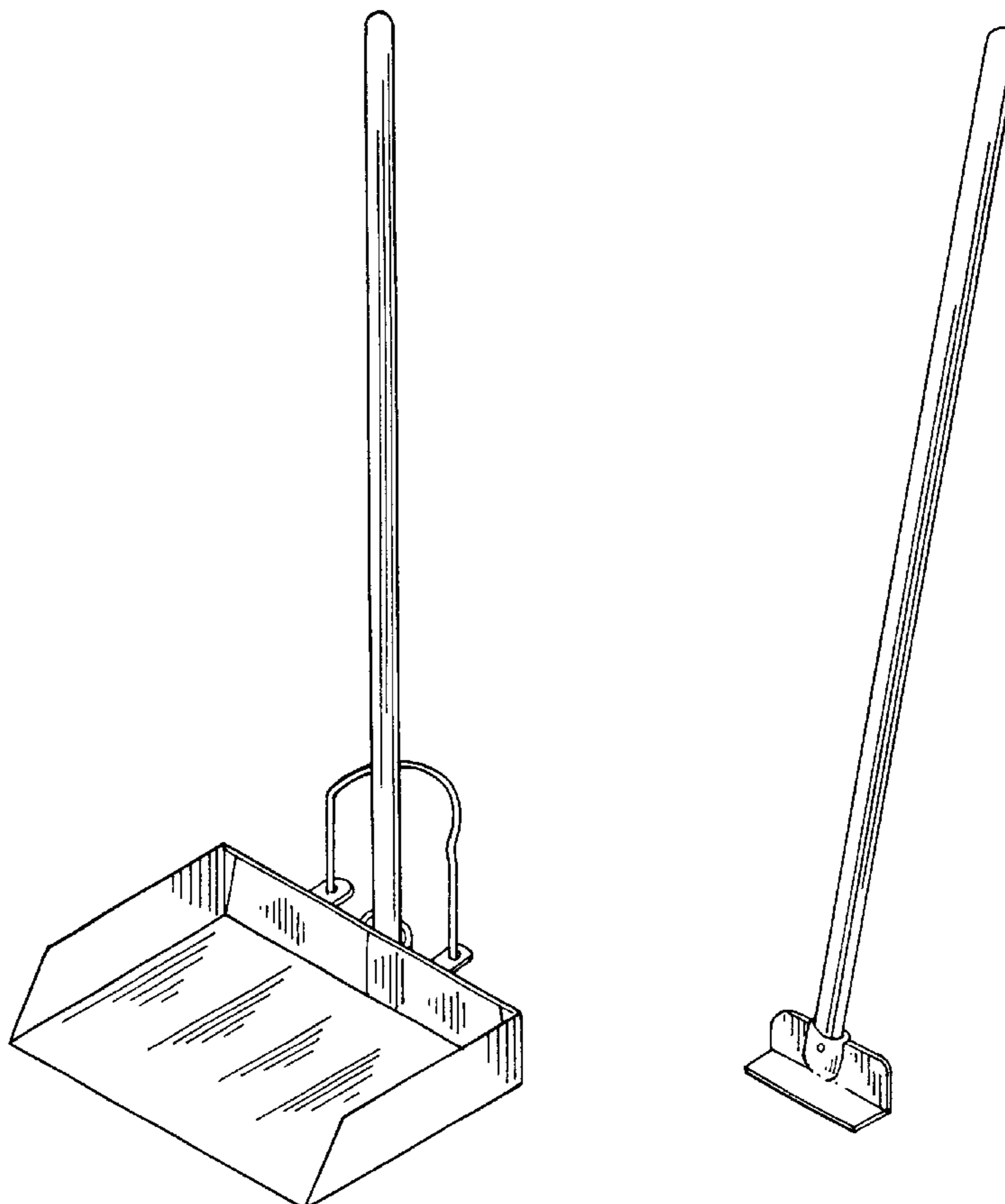

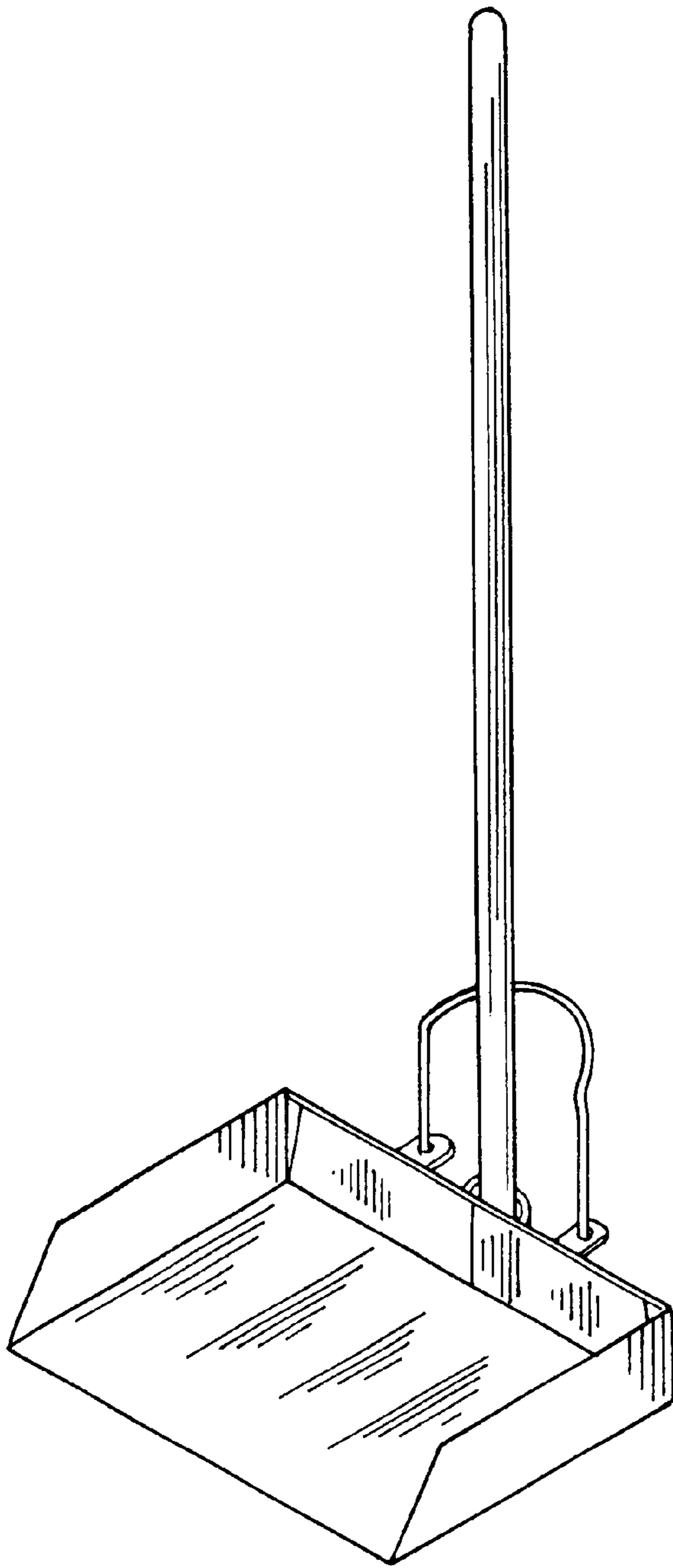

FIG. 1

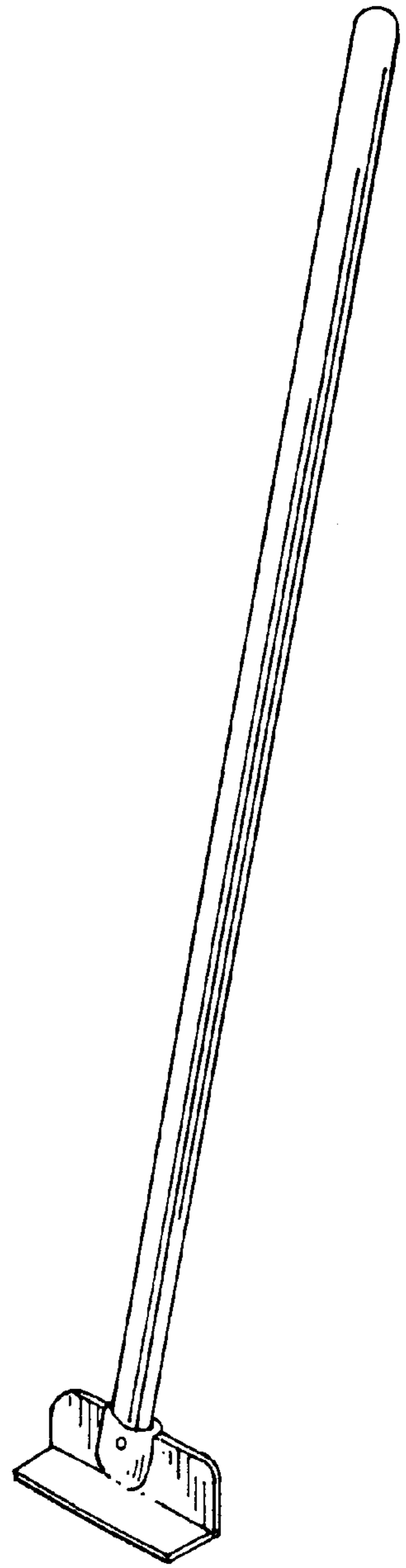

FIG. 2

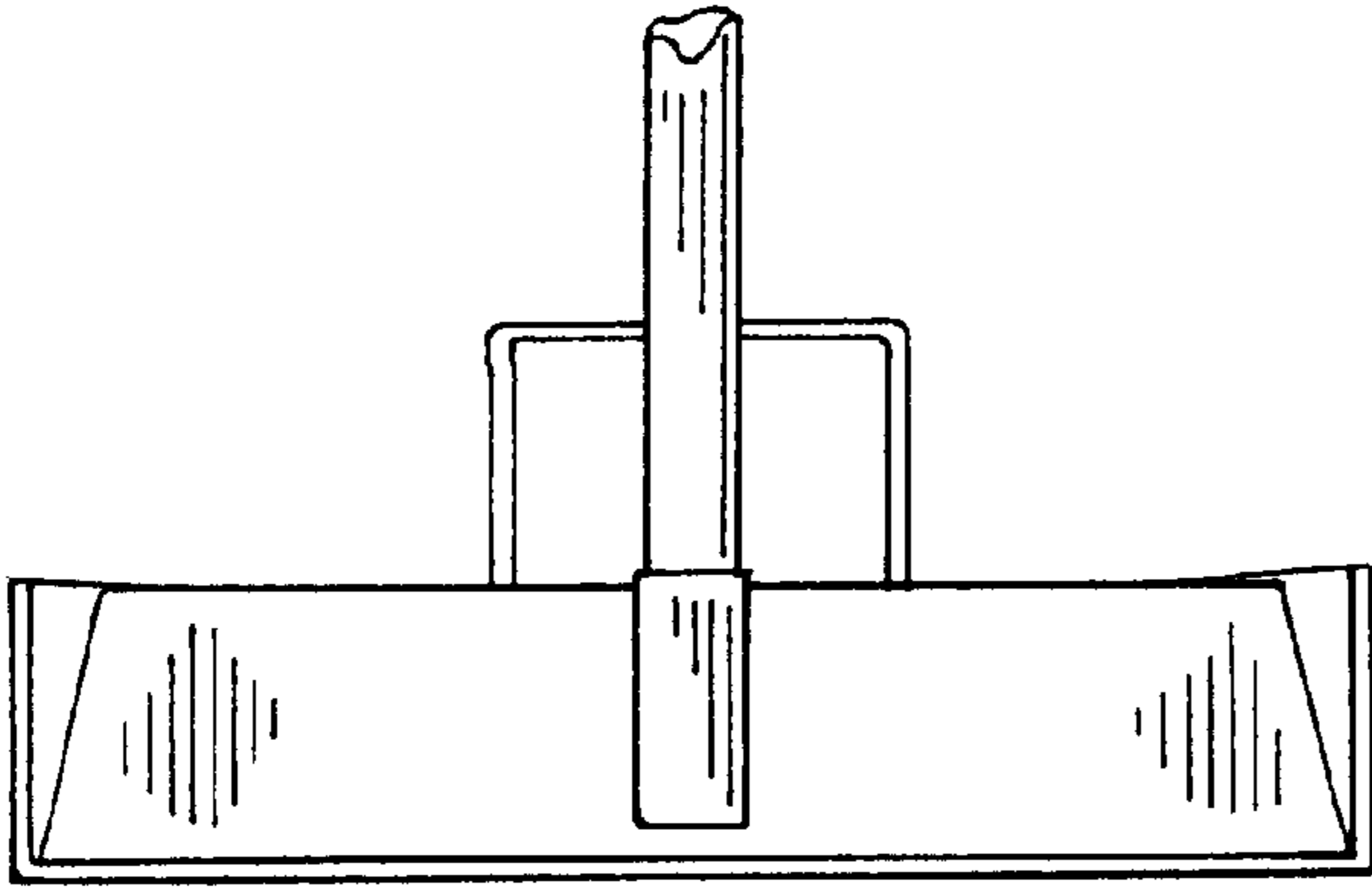

FIG. 3

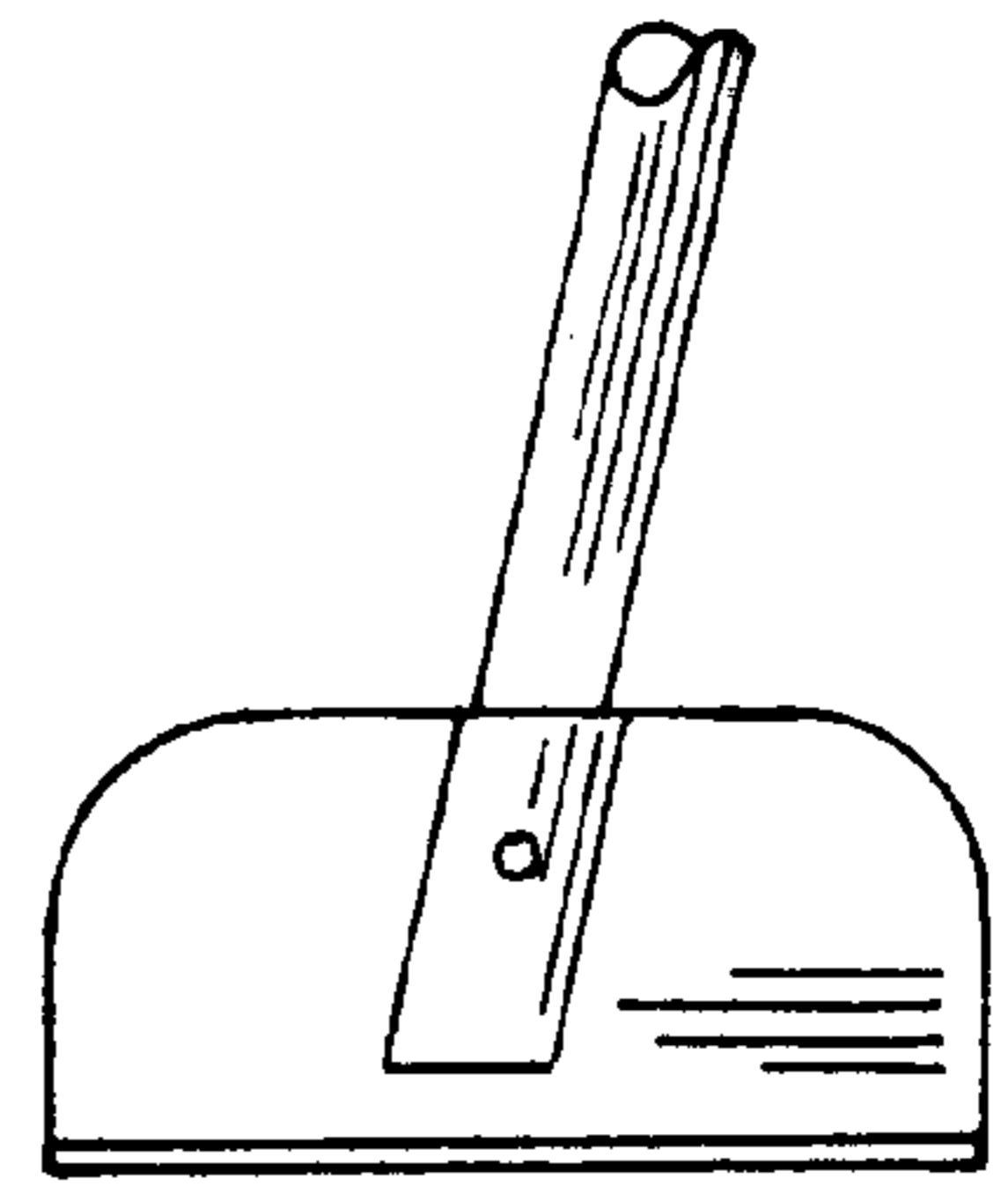

FIG. 4

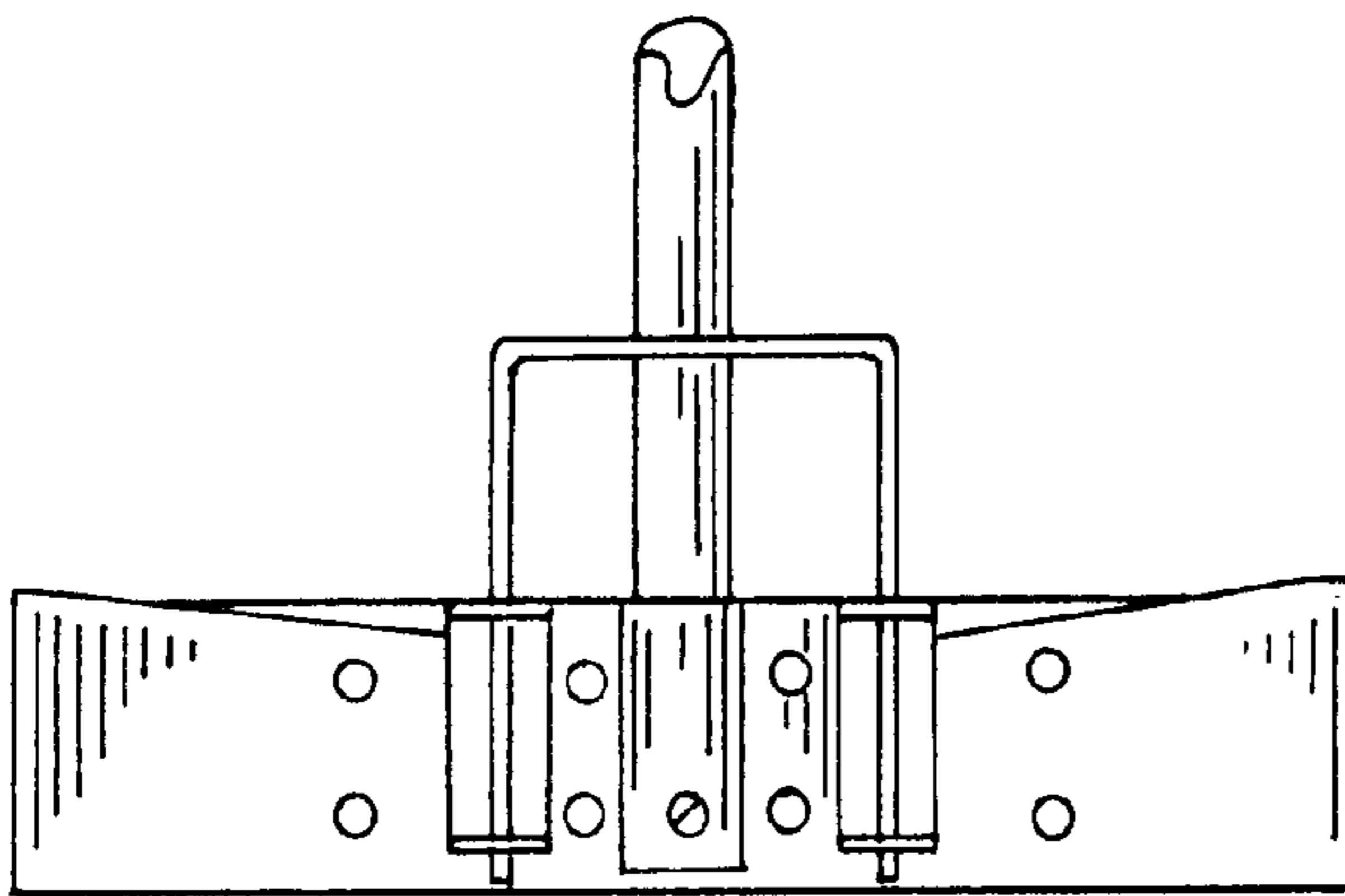

FIG. 5

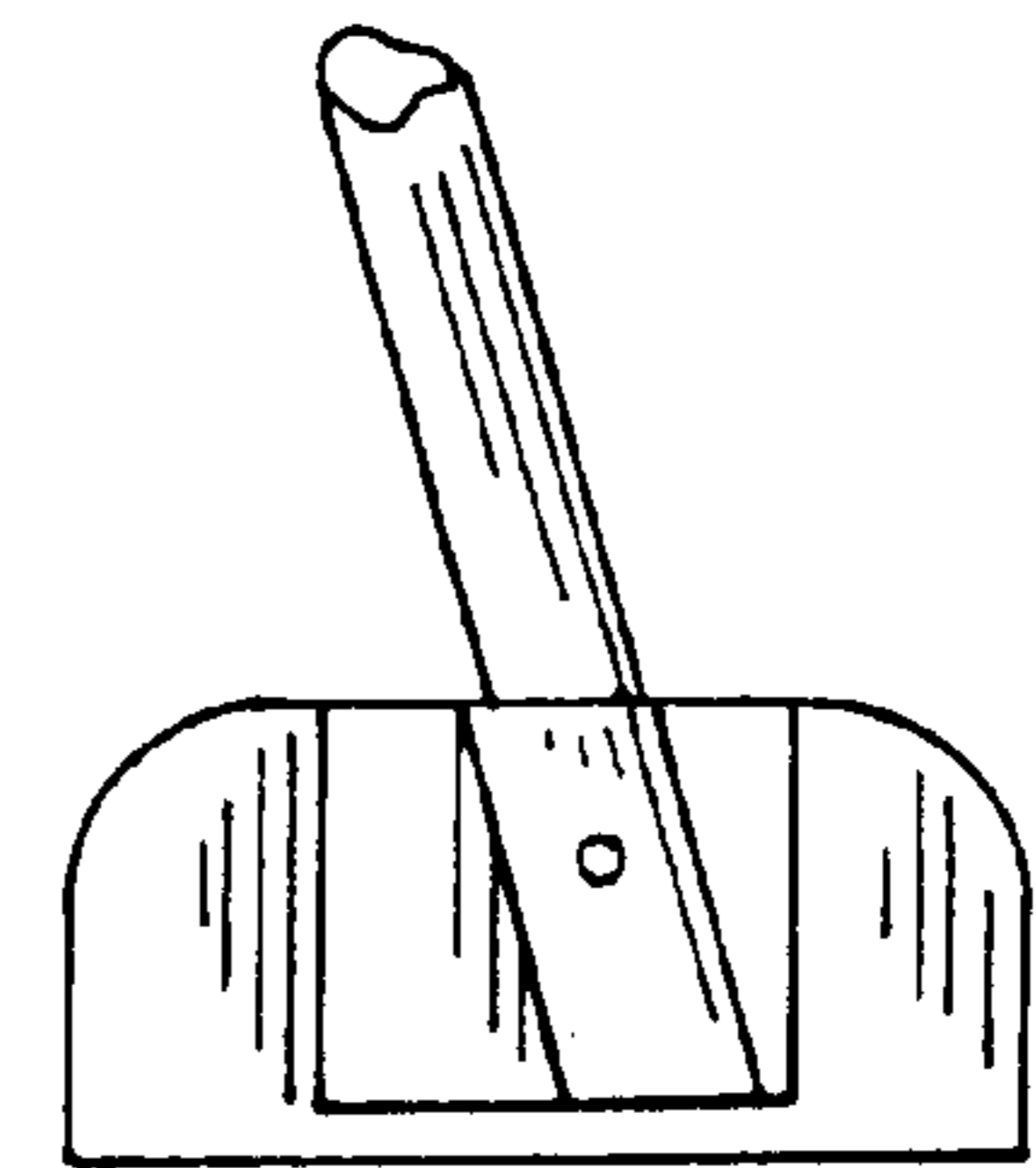

FIG. 6

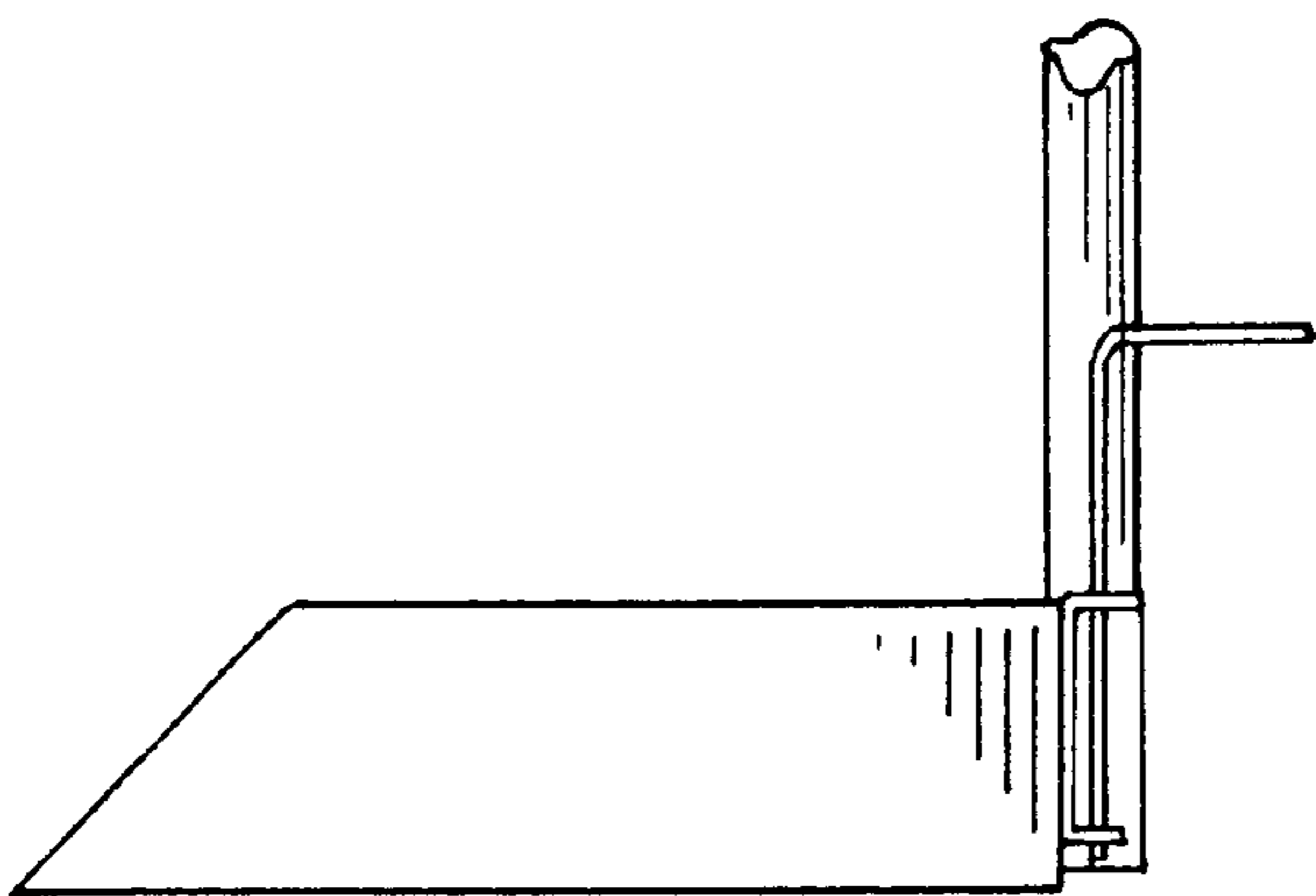

FIG. 7

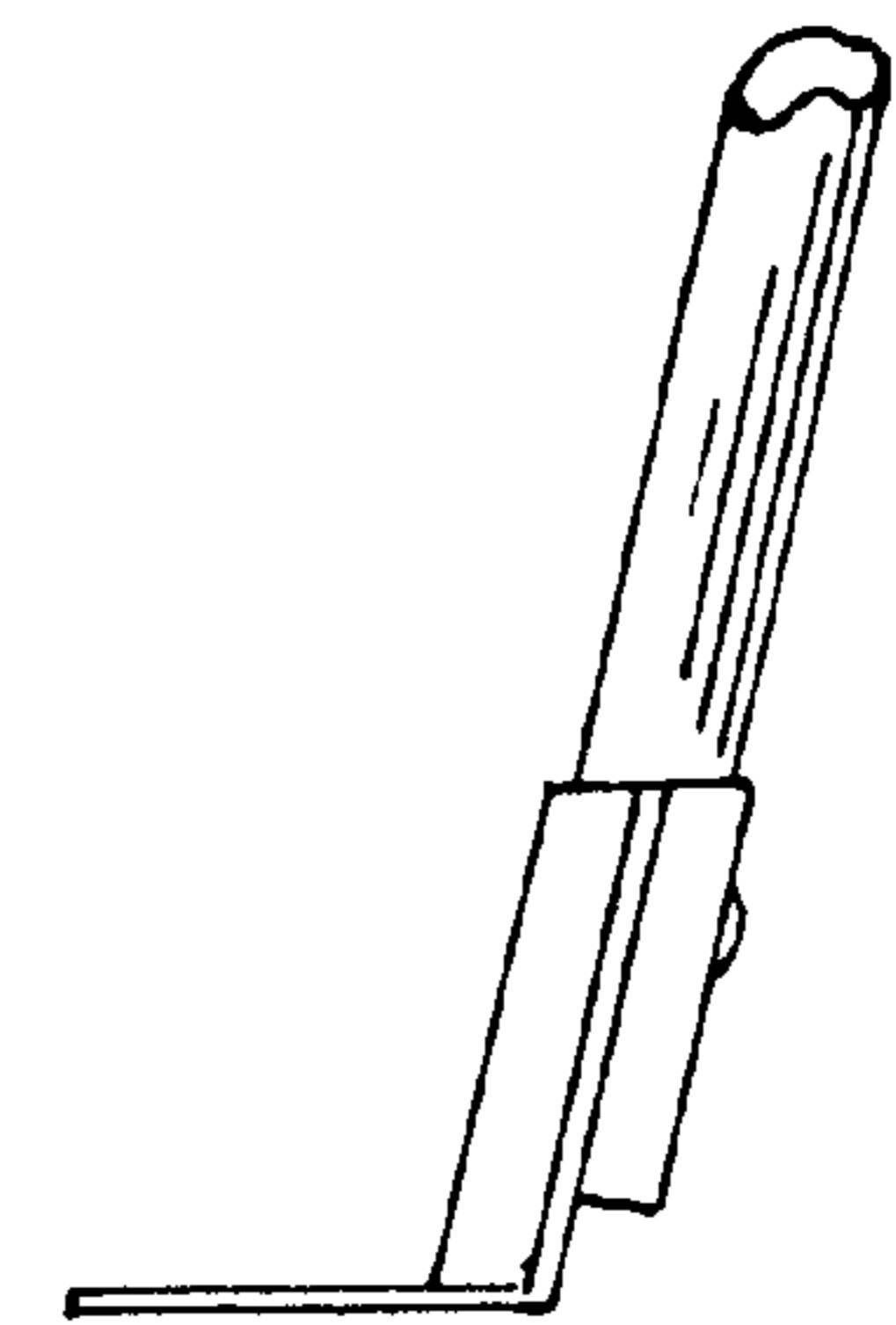

FIG. 8